

01	02
03	04
05	06
07	08
09	10
11	12
13	14
15	16
17	18
19	20
21	22
23	24
25	26
27	28
29	30
31	32
33	34
35	36
37	38
39	40
41	42
43	44
45	46
47	48
49	50
51	52
53	54
55	56
57	58
59	60
61	62
63	64
65	66
67	68
69	70
71	72
73	74
75	76
77	78
79	80
81	82
83	84
85	86
87	88
89	90
91	92
93	94
95	96
97	98
99	100

A B C D E F G H

1

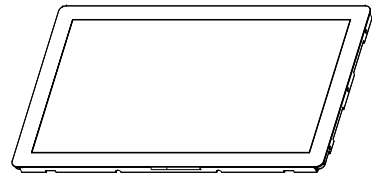
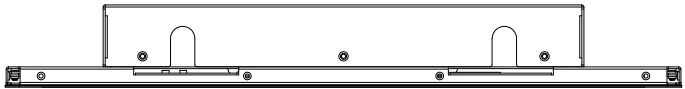

1:2

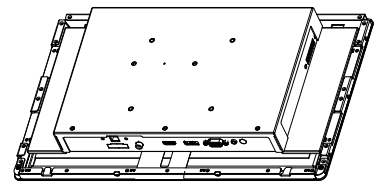

1:2

2

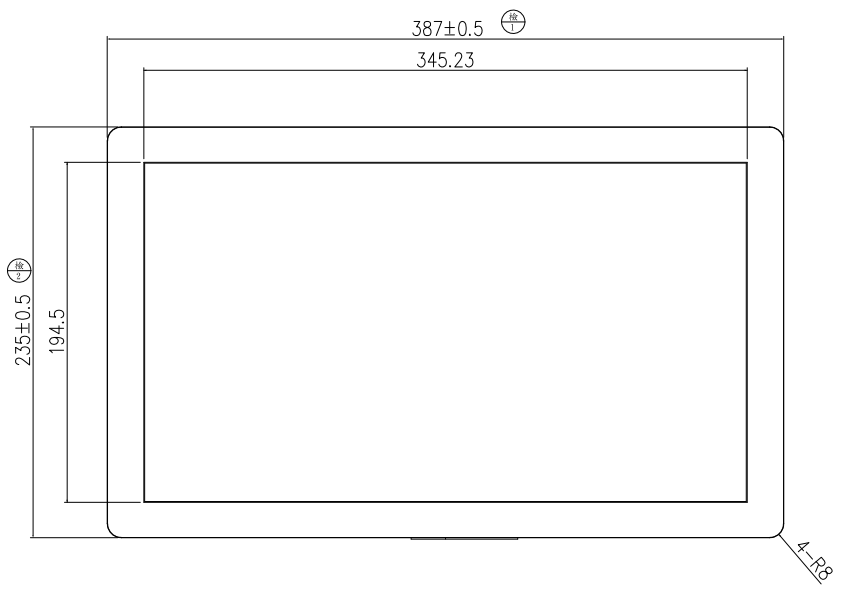

3

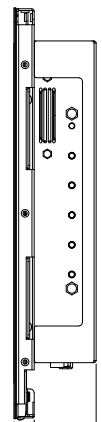
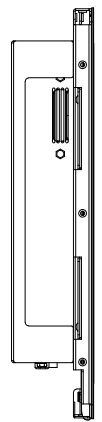

4

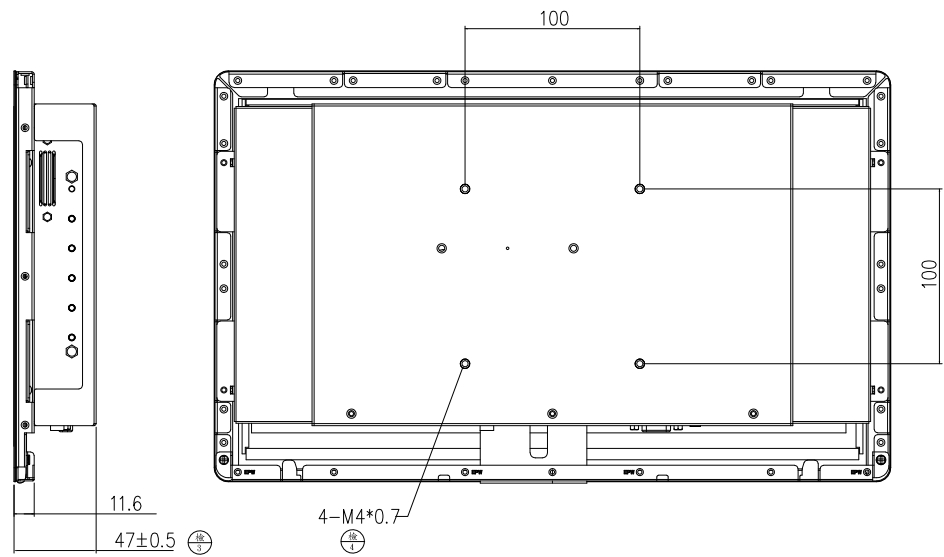

5



REV	DATE	BY	CHK	APP	QTY	UNIT	REMARKS
01	2014.11.11	WJ	WJ	WJ	1	PCS	
02	2014.11.11	WJ	WJ	WJ	1	PCS	
03	2014.11.11	WJ	WJ	WJ	1	PCS	
04	2014.11.11	WJ	WJ	WJ	1	PCS	
05	2014.11.11	WJ	WJ	WJ	1	PCS	
06	2014.11.11	WJ	WJ	WJ	1	PCS	
07	2014.11.11	WJ	WJ	WJ	1	PCS	
08	2014.11.11	WJ	WJ	WJ	1	PCS	
09	2014.11.11	WJ	WJ	WJ	1	PCS	
10	2014.11.11	WJ	WJ	WJ	1	PCS	
11	2014.11.11	WJ	WJ	WJ	1	PCS	
12	2014.11.11	WJ	WJ	WJ	1	PCS	
13	2014.11.11	WJ	WJ	WJ	1	PCS	
14	2014.11.11	WJ	WJ	WJ	1	PCS	
15	2014.11.11	WJ	WJ	WJ	1	PCS	
16	2014.11.11	WJ	WJ	WJ	1	PCS	
17	2014.11.11	WJ	WJ	WJ	1	PCS	
18	2014.11.11	WJ	WJ	WJ	1	PCS	
19	2014.11.11	WJ	WJ	WJ	1	PCS	
20	2014.11.11	WJ	WJ	WJ	1	PCS	

ΔE	≤ 1.5	-1	≤ ΔL · Δa · Δb	1
----	-------	----	----------------	---