

ARC-21W38

21.5" 11th Generation Intel® Core™ i3/i5/i7 Processors
Fanless Rugged Touch Panel PC with IET Expansion

Quick Reference Guide

1st Ed – 13 December 2023

Copyright Notice

Copyright © 2023 Avalue Technology Inc., ALL RIGHTS RESERVED.

Document Amendment History

| Revision | Date | By | Comment |
|-----------------|---------------|--------|-----------------|
| 1 st | November 2023 | Avalue | Initial Release |

Declaration of Conformity



This device complies with part 15 fcc rules. Operation is subject to the following two conditions:

(1) This device may not cause harmful interference.

(2) This device must accept any interference received including interference that may cause undesired operation.

This equipment has been tested and found to comply with the limits for a class "a" digital device, pursuant to part 15 of the fcc rules.

These limits are designed to provide reasonable protection against harmful interference when the equipment is operated in a commercial environment. This equipment generates, uses, and can radiate radio frequency energy and, if not installed and used in accordance with the instruction manual, may cause harmful interference to radio communications.

Operation of this equipment in a residential area is likely to cause harmful interference in which case the user will be required to correct the interference at his own expense.

CE statement

The product(s) described in this manual complies with all application European Union (CE) directives if it has a CE marking. For computer systems to remain CE compliant, only CE-compliant parts may be used. Maintaining CE compliance also requires proper cable and cabling techniques.

Notice

This guide is designed for experienced users to setup the system within the shortest time. For detailed information, please always refer to the electronic user's manual.

Copyright Notice

© 2023 by Avalue Technology Inc. All rights are reserved. No parts of this manual may be copied, modified, or reproduced in any form or by any means for commercial use without the prior written permission of Avalue Technology Inc. All information and specification provided in this manual are for reference only and remain subject to change without prior notice.

Acknowledgements

Intel and Pentium are trademarks of Intel Corporation.

Microsoft Windows is registered trademark of Microsoft Corp.

All other product names or trademarks are properties of their respective owners.

Disclaimer

This manual is intended to be used as a practical and informative guide only and is subject to change without notice. It does not represent a commitment on the part of Avalue. This

product might include unintentional technical or typographical errors. Changes are periodically made to the information herein to correct such errors, and these changes are incorporated into new editions of the publication.

A Message to the Customer

Avalue Customer Services

Each and every Avalue's product is built to the most exacting specifications to ensure reliable performance in the harsh and demanding conditions typical of industrial environments. Whether your new Avalue device is destined for the laboratory or the factory floor, you can be assured that your product will provide the reliability and ease of operation for which the name Avalue has come to be known.

Your satisfaction is our primary concern. Here is a guide to Avalue's customer services. To ensure you get the full benefit of our services, please follow the instructions below carefully.

Technical Support and Assistance

1. Visit the Avalue website at <https://www.avalu.com.tw/> where you can find the latest information about the product.
2. Contact your distributor or our technical support team or sales representative for technical support if you need additional assistance. Please have following information ready before you call:
 - Product name and serial number
 - Description of your peripheral attachments
 - Description of your software (operating system, version, application software, etc.)
 - A complete description of the problem
 - The exact wording of any error messages

To receive the latest version of the user's manual; please visit our Web site at:

www.avalu.com.tw

Product Warranty (Returns & Warranties policy)

1. Purpose

Avalue establishes the following maintenance specifications and operation procedures for providing the best quality of service and shortened repair time to our customers.

2. Warranty

2.1 Warranty Period

Avalue endeavors to offer customers the most comprehensive post-sales services and protection; besides offering a 2-year warranty for standard Avalue products, an extended warranty service can also be provided based on additional request from the customer. Within the warranty period, customers are entitled to receive comprehensive and prompt repair and warranty.

Standard products manufactured by Avalue are offered a 2-year warranty, from the date of delivery from Avalue. For ODM/OEM products manufactured by Avalue or PCBA with conformal coating, will follow up the define warranty of the agreement, otherwise will be offered 1-year warranty for ODM/OEM products but non-warranty for PCBA with conformal coating. For outsourcing parts kit by Avalue (ex: Motherboard, LCD touch panel, CPU, RAM, HDD) are offered a 6-month warranty, and Mobile/Tablet PC battery are offered a warranty of the half year, from the date of delivery by Avalue. Products before the mass production stage, i.e. engineering samples are not applied in this warranty or service policy. For extended warranty and cross-territory services, product defects resulting from design, production process or material are covered by the pre-set warranty period after the date of delivery from Avalue. For non-Avalue products, the product warranty and repair time shall be based on the service standards provided by the original manufacturer; in principle Avalue will provide these products a warranty service for no more than one year.

2.2 Maintenance services within the warranty period

In the case of Avalue product DOA (Defect-on-Arrival) when the customer finds any defect within 1 month after the delivery, Avalue will replace it with a new product in a soonest way. Except for custom products, once the customer is approved of a Cross-Shipment Agreement, which allows for delivery a new product to the customer before receiving the defective one, Avalue will immediately proceed with new product replacement for the said DOA case. On validation of the confirmed defect, Avalue is entitled to reserve the right whether to provide a new product for replacement. For the returned defective new product, it is necessary to verify that there shall be no bruise, alteration, scratch or marking to the appearance, and that none of the delivered accessories missing; otherwise, the customer will be requested to pay a processing fee. On the other hand, if the new product defect is resulting from incorrect configuration or erroneous use by the user instead of any problem of the hardware itself, the customer will also be requested to pay for relevant handling fees.

ARC-21W38

As for other conditions, Avalue will handle defects by way of repair. The customer will be requested to send the defective product to an Avalue authorized service center, and Avalue will return the repaired product back to the customer as soon as possible.

2.3 Ruling of an out-of-warranty defect

The following situations are not included in the warranty:

- The warranty period has expired.
- Product has been altered or its label of the serial number has been torn off.
- Product functionality issues resulting from improper use by the user, unauthorized dismantle or alteration, unfit operation environment, improper maintenance, accident or other causes. Avalue reserves the right for the ruling of the aforementioned situations.
- Product damage resulting from lightning, flood, earthquake or other calamities.
- The warranty rules of non-Avalue products and accessories shall be in accordance with standards set up by the original manufacturer. These products and accessories include RAM, HDD, FDD, CD-ROM, CPU, FAN, etc.
- Product upgrade request or test request submitted by the customer after expiration of the warranty.
- PCBA with conformal coating.
- Avalue semi-product and outsourced products without Avalue serial number.
- Products before the mass production stage, i.e. engineering samples.

3. Procedure for sending for repair

3.1 Attain a RMA number

A customer's rejected product returned for repair shall have a RMA (Return Merchandise Authorization) number. Without a RMA number, Avalue will not provide any repair service for the rejected product, and the product will be returned to the customer at customer's cost. Avalue will not issue any notice for the return of the product.

Each returned product for repair shall have a RMA number, which is simply the authorization of the return for repair; it is not a guarantee that the returned goods can be repaired or replaced. For applying for a RMA number, the customer may enter the eRMA webpage of Avalue <https://myavalue.avalue.com.tw/> and log-in with an account number and a password authorized by Avalue. The system will then automatically issue a RMA number.

When applying for the RMA number, it is essential to fill in basic information of the customer and the product, together with detailed description of the problem encountered. If possible, avoid using ambiguous words such as "does not work" or "problematic". Without a substantial description of the problem, it is hard to start the repair and will cause prolonged repair time. Lacking detailed statement of fault steps also makes the problem hard to be identified, sometimes resulting in second-time repairs.

In case the customer can't define the cause of problem, please contact Avalue application engineers. Sometimes when the problem can be resolved even before the customer sends back the product.

On the other hand, if the customer only returns the key parts to Avalue for repair, it is necessary that the serial number of the entire unit is given in the "Problem Description" field, so that warranty period can be ruled accordingly; or Avalue will handle the case as an Out-of-warranty case.

3.2 Return of faulty product for repair

It is recommended that the customer not to return the accessories (manual, connection cables, etc.) with the products for repair, devices such as CPU, DRAM, CF memory card, etc., shall also be removed from the faulty goods before return for repair. If these devices are relevant to described repair problems and necessary to be returned with the goods; please clearly indicate the items included in the eRMA application form. Avalue shall not be responsible for any item that is not itemized. Moreover, make sure the problem(s) are detailed in the "Problem Description" field.

In the list of delivery, the customer may fill-in a value which is lower than the actual value, to prevent customs levying a higher tax over the excessive value of the return goods. The customer shall be held responsible for extra fees caused by this. We strongly recommend that "Invoice for customs purpose only with no commercial value" be indicated on the delivery note. Also for the purpose of expedited handling, please printout the RMA number and put it in the carton, also indicate the number outside of the carton, with the recipient addressing to Avalue RMA Department.

When returning the defective product, please use an anti-static bag or ESD material to pack it properly. In case of improper packing resulting in damages in the transportation process, Avalue reserves the right to reject the un-repaired faulty good at the customer's costs. Furthermore, it is suggested that the faulty goods shall be sent via a door-to-door courier service. The customer shall be held responsible for any customs clearance fee or extra expenses if Air-Cargo is used for the delivery.

In case of a DOA situation of a new product, Avalue will be responsible for the product and the freight. If the faulty goods are within the warranty period, the sender will take responsibility for the freight. For an out-of-warranty case, the customer shall be responsible for the freight of both trips.

3.3 Maintenance Charge

Avalue will charge a moderate repair fee for the following conditions:

- The warranty period has expired.
- Product has been altered or its label of the serial number has been torn off.
- Product functionality issues resulting from improper use by the user, unauthorized dismantle or alteration, unfit operation environment, improper maintenance, accident

ARC-21W38

or other causes. Avalue reserves the right for the ruling of the aforementioned situations.

- Product damage resulting from lightning, flood, earthquake or other calamities.
- The warranty rules for non-Avalue products and accessories shall be in accordance with standards set up by the original supplier. These products and accessories include RAM, HDD, FDD, CD-ROM, CPU, FAN, etc.
- Product upgrade request or test request submitted by the customer after expiry of the warranty.
- PCBA with conformal coating.
- Avalue semi-product and outsourced products without Avalue serial number
- Products before the mass production stage, i.e. engineering samples.
- In case the products received are examined as NPF (No Problem Found) within the warranty period, the customer shall be responsible for the freight of both trips.
- Please contact your local distributor to examine in advance to prevent unnecessary freight cost.

For system failure of out-of-warranty products, Avalue will provide a quotation prior to repair service. When the customer applies for the cost, please refer to the Quotation number. In case the customer does not return the DOA product that has already been replaced by a new one, or the customer does not sign back the quotation of the out-of-warranty maintenance, Avalue reserves the right of whether or not to provide the repair service. In case the customer does not reply in 3 months, Avalue shall directly scrap or return the product back to customer at customer's cost without further notice to the customer.

3.4 Maintenance service of phased-out products

For servicing phased-out products, Avalue provides an extended period, starting the date of phase-out, as a guaranteed maintenance period of such products, for continuance of the maintenance service to meet customer's requirements. In case of unexpected factors causing Avalue to be unable to repair/replace a warranted but phased-out product, Avalue will, depending on the availability, upgrade the product (free of charge with continued warranty period as of the original product), or, give partial refund (based on the length of the remaining warranty period) to solve this kind of problem.

3.5 Maintenance Report

On completion of repair of a defective product, a Maintenance Report indicating the maintenance result and part(s) replaced (if any) will be sent to the customer together with the product. If the customer demands an additional maintenance analysis report, a service fee of various level will be charged depending on the warranty status. In case the analysis result shows that the defect attributes to Avalue's faulty design or process, the analysis fee will be exempted.

4. Service Products

Avalue provides service products to manage with different customer needs. Should you have any need, please consult to Avalue Sales Department.

Defect Analysis Report (DAR)

Avalue provides DAR (Defect Analysis Report) services aiming to elevating customer satisfaction. A DAR includes defect cause identification/verification/suggestion and improvement precautions, with instructions on correct usage for the avoidance of any reoccurrence.

Upgrade Service

Avalue is capable to provide system upgrade service for customization requirements. This upgrade service is applicable for main parts, such as CPU, memory, HDD, SSD, storage devices; also replacements motherboards of systems. Please contact Avalue sales for details to evaluate the possibility of system upgrade service and obtain information of lead time and price.

Safety Instructions

Safety Precautions

Before installing and using this device, please note the following precautions.

1. Read these safety instructions carefully.
2. Keep this User's Manual for future reference.
3. Disconnected this equipment from any AC outlet before cleaning.
4. For plug-in equipment, the power outlet socket must be located near the equipment and must be easily accessible.
5. Keep this equipment away from humidity.
6. Put this equipment on a reliable surface during installation. Dropping it or letting it fall may cause damage.
7. Make sure the voltage of the power source is correct before connecting the equipment to the power outlet.
8. Use a power cord that has been approved for using with the product and that it matches the voltage and current marked on the product's electrical range label. The voltage and current rating of the cord must be greater than the voltage and current rating marked on the product.
9. Position the power cord so that people cannot step on it. Do not place anything over the power cord.
10. All cautions and warnings on the equipment should be noted.
11. If the equipment is not used for a long time, disconnect it from the power source to

ARC-21W38

avoid damage by transient overvoltage.

12. Never pour any liquid into an opening. This may cause fire or electrical shock.











13. Never open the equipment. For safety reasons, the equipment should be opened only by qualified service personnel. If one of the following situations arises, get the equipment checked by service personnel:

- The power cord or plug is damaged.
- Liquid has penetrated into the equipment.
- The equipment has been exposed to moisture.
- The equipment does not work well, or you cannot get it work according to the user's manual.
- The equipment has been dropped and damaged.
- The equipment has obvious signs of breakage.





14. **CAUTION:** Danger of explosion if battery is incorrectly replaced. Replace only with the same or equivalent type recommended by the manufacturer.

15. Equipment intended only for use in a **RESTRICTED ACCESS AREA**.

Explanation of Graphical Symbols

| | | |
|---|---------|--|
|  | Warning | A WARNING statement provides important information about a potentially hazardous situation which, if not avoided, could result in death or serious injury. |
|  | Caution | A CAUTION statement provides important information about a potentially hazardous situation which, if not avoided, may result in minor or moderate injury to the user or patient or in damage to the equipment or other property. |
|  | Note | A NOTE provides additional information intended to avoid inconveniences during operation. |
|  | | Direct current. |
|  | | Alternating current |
|  | | Stand-by, Power on |
|  | | FCC Certification |
|  | | CE Certification |
|  | | Follow the national requirements for disposal of equipment. |
|  | | Stacking layer limit |
|  | | This side up |

ARC-21W38

| | | |
|---|--|--|
|  | | Fragile Packaging |
|  | | Beware of water damage, moisture-proof |
|  | | Carton recyclable |
|  | | Handle with care |
|  | | Follow operating instructions of consult instructions for use. |

Disposing of your old product

WARNING:

There is danger of explosion if the battery is mishandled or incorrectly replaced. Replace only with the same type of battery. Do not disassemble it or attempt to recharge it outside the system. Do not crush, puncture, dispose of in fire, short the external contacts, or expose to water or other liquids. Dispose of the battery in accordance with local regulations and instructions from your service provider.

CAUTION:

- Lithium Battery Caution: Danger of explosion if battery is incorrectly replaced. Replace only with same or equivalent type. Dispose batteries according to manufacturer's instructions.
- Disposal of a BATTERY into fire or a hot oven, or mechanically crushing or cutting of a BATTERY, that can result in an EXPLOSION
- Leaving a BATTERY in an extremely high temperature surrounding environment that can result in an EXPLOSION or the leakage of flammable liquid or gas.
- A BATTERY subjected to extremely low air pressure that may result in an EXPLOSION or the leakage of flammable liquid or gas.

Mise en garde!

AVERTISSEMENT : Il existe un risque d'explosion si la batterie est mal manipulée ou remplacée de manière incorrecte. Remplacez uniquement par le même type de batterie. Ne le démontez pas et ne tentez pas de le recharger en dehors du système. Ne pas écraser, percer, jeter au feu, court-circuiter les contacts externes ou exposer à l'eau ou à d'autres liquides. Jetez la batterie conformément aux réglementations locales et aux instructions de votre fournisseur de services.

MISE EN GARDE:

- Pile au lithium Attention : Danger d'explosion si la pile n'est pas remplacée correctement. Remplacer uniquement par un type identique ou équivalent. Jetez les piles conformément aux instructions du fabricant.
- L'élimination d'une BATTERIE dans le feu ou dans un four chaud, ou l'écrasement ou le découpage mécanique d'une BATTERIE, pouvant entraîner une EXPLOSION
- Laisser une BATTERIE dans un environnement à température extrêmement élevée pouvant entraîner une EXPLOSION ou une fuite de liquide ou de gaz inflammable.
- UNE BATTERIE soumise à une pression d'air extrêmement basse pouvant entraîner une EXPLOSION ou une fuite de liquide ou de gaz inflammable.

Content

| | | |
|-----------|--|-----------|
| 1. | Getting Started | 18 |
| 1.1 | Safety Precautions | 18 |
| 1.2 | Packing List..... | 18 |
| 1.3 | System Specifications | 20 |
| 1.4 | System Overview | 24 |
| 1.4.1 | I/O View | 24 |
| 1.5 | System Dimensions | 25 |
| 2. | Hardware Configuration | 26 |
| 2.1 | ARC-21W38 connector mapping..... | 27 |
| 2.1.1 | Serial port 1 connector (COM1)..... | 27 |
| 2.1.2 | Serial port 2 connector (COM2)..... | 28 |
| 2.2 | Powering On the System | 29 |
| 2.3 | ARC-TGL Overview | 30 |
| 2.4 | ARC-TGL Jumper and Connector List | 31 |
| 2.5 | ARC-TGL Jumpers & Connectors settings..... | 33 |
| 2.5.1 | Clear CMOS (JBAT1) | 33 |
| 2.5.2 | LCD backlight brightness adjustment (JSBKL1) | 33 |
| 2.5.3 | AT/ATX Input power select (JSATX1) | 34 |
| 2.5.4 | Serial port 1 in RS-232/422/485 mode (JCOM_SEL1)..... | 34 |
| 2.5.5 | M.2 KEY power select (JP1)..... | 35 |
| 2.5.6 | LCD Inverter connector (JBKL1) | 35 |
| 2.5.7 | On-board header for USB2.0 (JUSB1)..... | 36 |
| 2.5.8 | Touch connector (JTP1) co-lay USB2.0 header (JUSB3)..... | 36 |
| 2.5.9 | LVDS connector (LVDS1)..... | 37 |
| 2.5.10 | AMPLIFIER_R (JSPKR1) | 38 |
| 2.5.11 | AMPLIFIER_L (JSPKL1) | 38 |
| 2.5.12 | Battery connector (BT1) | 39 |
| 2.5.13 | SPI connector (JSPI1) | 39 |
| 2.5.14 | B2B connector (JB2B1) | 40 |
| 2.5.15 | General purpose I/O connector (JGPIO1)..... | 41 |
| 2.5.16 | SATA Power connector (SATAPW1)..... | 41 |
| 2.5.17 | LPC connector (JLPC1)..... | 42 |
| 2.5.18 | Front Panel connector (JFP1) | 42 |
| 2.6 | ARC-BYT DB-A/B/C/D/E/F/G/H/K Overviews | 43 |
| 14 | ARC-21W38 Quick Reference Guide | |

| | | |
|-------------|---|-----------|
| 2.6.1 | ARC-BYT DB-A | 43 |
| 2.6.2 | ARC-BYT DB-B | 43 |
| 2.6.3 | ARC-BYT DB-C | 43 |
| 2.6.4 | ARC-BYT DB-D | 44 |
| 2.6.5 | ARC-BYT DB-E | 44 |
| 2.6.6 | ARC-BYT DB-F..... | 44 |
| 2.6.7 | ARC-BYT DB-G | 45 |
| 2.6.8 | ARC-BYT DB-H | 45 |
| 2.6.9 | ARC-BYT DB-K | 45 |
| 2.7 | ARC-BYT DB-A/B/C/D/E/F/G/H/K Connector list | 46 |
| 2.7.1 | ARC-BYT DB-A | 46 |
| 2.7.2 | ARC-BYT DB-B | 46 |
| 2.7.3 | ARC-BYT DB-C | 46 |
| 2.7.4 | ARC-BYT DB-D | 46 |
| 2.7.5 | ARC-BYT DB-E | 46 |
| 2.7.6 | ARC-BYT DB-F..... | 47 |
| 2.7.7 | ARC-BYT DB-G | 47 |
| 2.7.8 | ARC-BYT DB-H | 47 |
| 2.7.9 | ARC-BYT DB-K | 47 |
| 2.8 | ARC-BYT DB-D Connectors settings | 49 |
| 2.8.1 | Serial Port 1 connector (D_COM1)..... | 49 |
| 2.8.2 | Serial Port 2 connector (D_COM2)..... | 49 |
| 2.9 | ARC-BYT DB-E Jumpers & Connectors settings | 50 |
| 2.9.1 | CAN2.0 Switch (E_JCAN20) | 50 |
| 2.9.2 | For user update FW (E_JBOOT0)..... | 50 |
| 2.9.3 | For user update FW (E_JIAP1) | 51 |
| 2.10 | ARC-BYT DB-F Connectors settings | 53 |
| 2.11 | ARC-BYT DB-G Connectors settings..... | 54 |
| 2.11.1 | Serial Port 1 connector (G_COM1) | 54 |
| 2.11.2 | Serial Port 2 connector (G_COM2) | 54 |
| 2.11.3 | Serial Port 3 connector (G_COM3) | 55 |
| 2.12 | ARC-BYT DB-H Jumpers settings..... | 55 |
| 2.12.1 | USB Power selector (H_USB_PWR_SEL1)..... | 55 |
| 2.13 | ARC-BYT DB-H Connectors settings | 56 |
| 2.13.1 | Serial Port 1 connector (H_COM1)..... | 56 |
| 2.13.2 | Serial Port 2 connector (H_COM2)..... | 56 |
| 2.14 | ARC-BYT DB-K Connectors settings | 57 |
| 2.14.1 | Serial Port 1 connector (I_COM1) | 57 |
| 2.14.2 | Serial Port 2 connector (I_COM2) | 57 |
| 3. | Installation | 58 |

ARC-21W38

| | | |
|-----------|---|-----------|
| 3.1 | Installing Memory | 60 |
| 3.2 | Installing SSD..... | 61 |
| 3.3 | Installing ARC-BYT DB | 62 |
| 3.4 | System Mounting | 64 |
| 3.4.1 | Wall Mounting..... | 65 |
| 3.4.2 | Arm/ Stand Mounting..... | 67 |
| 3.4.3 | Panel Mounting..... | 68 |
| 3.4.4 | VESA Mounting | 70 |
| 4. | Drivers Installation..... | 71 |
| 4.1 | Install Chipset Driver | 72 |
| 4.2 | Install VGA Driver..... | 73 |
| 4.3 | Install ME Driver..... | 74 |
| 4.4 | Install USB Driver..... | 75 |
| 4.5 | Install Audio Driver (For Realtek ALC888S)..... | 76 |
| 4.6 | Install LAN Driver | 77 |
| 5. | BIOS Setup..... | 79 |
| 5.1 | Introduction | 80 |
| 5.2 | Starting Setup | 80 |
| 5.3 | Using Setup | 81 |
| 5.4 | Getting Help..... | 82 |
| 5.5 | In Case of Problems..... | 82 |
| 5.6 | BIOS setup..... | 83 |
| 5.6.1 | Main Menu..... | 83 |
| 5.6.1.1 | System Language..... | 84 |
| 5.6.1.2 | System Date | 84 |
| 5.6.1.3 | System Time..... | 84 |
| 5.6.2 | Advanced Menu..... | 84 |
| 5.6.2.1 | Connectivity Configuration..... | 85 |
| 5.6.2.2 | CPU Configuration..... | 85 |
| 5.6.2.3 | Power & Performance | 86 |
| 5.6.2.3.1 | CPU – Power Management Control | 87 |
| 5.6.2.4 | PCH-FW Configuration | 88 |
| 5.6.2.4.1 | Firmware Update Configuration..... | 88 |
| 5.6.2.5 | Trusted Computing | 89 |
| 5.6.2.6 | APCI Settings | 89 |
| 5.6.2.7 | Super IO Configuration | 90 |
| 5.6.2.7.1 | Serial Port 1 Configuration | 91 |
| 5.6.2.7.2 | Serial Port 2 Configuration | 91 |
| 5.6.2.7.3 | Serial Port 3 Configuration | 92 |
| 5.6.2.7.4 | Serial Port 4 Configuration | 92 |

| | | |
|-------------|---|------------|
| 5.6.2.7.5 | Serial Port 5 Configuration | 93 |
| 5.6.2.8 | HW Monitor | 93 |
| 5.6.2.9 | S5 RTC Wake Settings | 94 |
| 5.6.2.10 | USB Configuration | 94 |
| 5.6.2.11 | Network Stack Configuration | 95 |
| 5.6.2.12 | NVMe Configuration | 96 |
| 5.6.3 | Chipset | 96 |
| 5.6.3.1 | System Agent (SA) Configuration | 97 |
| 5.6.3.1.1 | Memory Configuration | 97 |
| 5.6.3.1.2 | Graphics Configuration | 98 |
| 5.6.3.1.3 | VMD Configuration | 98 |
| 5.6.3.2 | PCH-IO Configuration | 99 |
| 5.6.3.2.1 | PCI Express Configuration | 99 |
| 5.6.3.2.1.1 | PCI Express Root Port 5(LAN2-I225) | 100 |
| 5.6.3.2.1.2 | PCI Express Root Port 6(M.2 KeyE) | 101 |
| 5.6.3.2.1.3 | PCI Express Root Port 8(JB2B1) | 102 |
| 5.6.3.2.2 | SATA And RST Configuration | 103 |
| 5.6.3.2.3 | HD Audio Configuration | 104 |
| 5.6.3.3 | Board & Panel Configuration | 104 |
| 5.6.3.3.1 | SHOW DMI INFO | 106 |
| 5.6.4 | Security | 106 |
| 5.6.4.1 | Secure Boot | 107 |
| 5.6.4.1.1 | Key Management | 108 |
| 5.6.5 | Boot | 109 |
| 5.6.6 | Save and exit | 110 |
| 5.6.6.1 | Save Changes and Reset | 110 |
| 5.6.6.2 | Discard Changes and Reset | 110 |
| 5.6.6.3 | Restore Defaults | 110 |
| 5.6.6.4 | Launch EFI Shell from filesystem device | 110 |
| 6. | Maintenance & Troubleshooting..... | 111 |
| 7. | Product Application..... | 117 |
| 8. | Operating the Device | 118 |

1. Getting Started

1.1 Safety Precautions

Warning!



Always completely disconnect the power cord from your chassis whenever you work with the hardware. Do not make connections while the power is on. Sensitive electronic components can be damaged by sudden power surges. Only experienced electronics personnel should open the PC chassis.

Caution!



Always ground yourself to remove any static charge before touching the CPU card. Modern electronic devices are very sensitive to static electric charges. As a safety precaution, use a grounding wrist strap at all times. Place all electronic components in a static-dissipative surface or static-shielded bag when they are not in the chassis.

1.2 Packing List

Before installation, please ensure all the items listed in the following table are included in the package.

| Item | Description | Q'ty |
|------|--------------------------------|------|
| 1 | ARC-21W38 Panel PC | 1 |
| 2 | Power Adapter | 1 |
| 3 | Screws for VESA | 4 |
| 4 | Screws for HDD | 4 |
| 5 | Screws for Wall Mount | 12 |
| 6 | Brackets for Wall Mount | 12 |
| 7 | Plastics spacer for Wall Mount | 12 |



If any of the above items is damaged or missing, contact your retailer.

Purposes and Applications

ARC-21W38 is used the Intel Atom® X-series (Elkhart Lake platform), which has stronger performance and lower power consumption. It also inherits from ARC-series strength, Modularized, Flexible Expansion, Reliability and Stability.

ARC series have been passed stricter vibration and shock testing. It can be used on extreme environment like manufacture or factory. Typical applications are HMI, Automation, POI, KIOSK. It also can be suitable for the customer's various application and scenario that need more ruggedized, vibration and water/dust-proof environment(IP65 Front Panel, IP41 Rear (except I/O)).

Unpacking

Note:

If any of the components listed in the checklist below are missing, do not proceed with the installation. Contact the Avalue reseller or vendor the product was purchased from or contact an Avalue sales representative directly by sending an email to sales@avalue.com.tw.

To unpack the flat bezel panel PC, follow the steps below.

WARNING!

The front side LCD screen has a protective plastic cover stuck to the screen. Only remove the plastic cover after the flat bezel panel PC has been properly installed. This ensures the screen is protected during the installation process.

Step 1: Carefully cut the tape sealing the box. Only cut deep enough to break the tape.

Step 2: Open the outside box.

Step 3: Carefully cut the tape sealing the box. Only cut deep enough to break the tape.

Step 4: Open the inside box.

Step 5: Lift the panel PC out of the boxes.

Step 6: Remove the peripheral parts box from the main box.

1.3 System Specifications

| System Information | |
|-----------------------------|---|
| SBC | ARC-TGL |
| Processor | On board 11th Gen. Intel® Core™ i7/i5/i3 BGA Processor Intel® Core™ i7- 1185G7E (15W, 12M Cache, up to 2.80 GHz), ST Intel® Core™ i5- 1145G7E (15W, 8M Cache, up to 2.60 GHz), ST Intel® Core™ i3- 1115G4E (15W, 6M Cache, up to 3.00 GHz), ST |
| CPU Cooler (Type) | Fanless |
| Memory | 1 x 260-pin SODIMM socket Max. up to 32GB DDR4 3200MT/s |
| Adapter | AC/DC adapter 24V/5A 120W, Screw Type |
| Speaker | 2 x 2W |
| Wireless LAN | Default N/A; Optional support by M.2 Key-E 2230 slot (Support PCIe/USB Wi-Fi/BT module & CNVi Wi-Fi/BT module) |
| Bluetooth | Default N/A; Optional support by M.2 Key-E 2230 slot (Support PCIe/USB Wi-Fi/BT module & CNVi Wi-Fi/BT module) |
| Operating System | Windows 10 / 11 Linux |
| Expansion Card | 2 x M.2 Slots: <ul style="list-style-type: none"> 1 x M.2 Key-E 2230 (PCIeIII x1, USB2.0 x1, CNVi) for Wi-Fi & BT Module (Support PCIe/USB Wi-Fi/BT module & CNVi Wi-Fi/BT module) 1 x M.2 Key-B 2242/3042/3052 with SIM card slot USB2.0 x1 SATA3/PCIeIII x1 (auto detect by switch IC) USB3.2 Gen 1x1 (5Gbp/s)/PCIeIII x1 (BOM option, default is USB3.2 Gen 1x1 (5Gbp/s)/ PCIeIII x 2 for NVMe) (3052 for 5G module) 1 x 80-pin Expansion IET interface |
| Other Component | SIM card slot (for 4G or 5G module) for M.2 Key-B 2242/3042/3052 |
| TPM | TPM 2.0 (by default) |
| Storage | |
| Solid State Drive | 1 x 2.5" Drive Bay |
| Other Storage Device | 1 x M.2 Key-B 2242/3042/3052 for M.2 SATAIII SSD by default, (PCIeIII x 2 for NVMe by BOM option) |

| Panel | |
|----------------------|---|
| LCD Panel | 21.5" 1920 x 1080, 500nits, 50Khrs |
| LCD Control Board | LED Driving board |
| Touch Screen | 21.5" PCAP Touch |
| Touch Controller | EETI |
| External I/O | |
| Serial Port | 1 x DB-9 COM1 (RS-232/422/485, selectable by BIOS & JUPMER, RS-485 supports Auto Flow, Pin-9 selected for Ring(default)/+5V/+12V by BOM option) 1 x DB-9 COM2 (RS-232, Pin-9 selected for Ring(default)/+5V/+12V by BOM option) |
| USB Port | 4 x USB3.2 Gen2x1 (10Gbp/s) (2 x Double deck) |
| DIO Port | 1 x 16-bit GPIO (by ARC-BYT DB-E) |
| Video Port | (Option By IET module only, (DB-B, DB-C) (Option By IET module only, AUX-080 (for 2xHDMI) |
| Audio Port | Realtek ALC888S & 897 co-layout (or other option decided by Avalue) |
| LAN Port | 1 x Intel® I225LM 2.5 Gigabit Ethernet 1 x Intel® I219LM Gigabit Ethernet PHY |
| Wireless LAN Antenna | 5 x Antenna hole on Top of back cover (2 x Antenna hole on empty IET bracket) |
| Indicator Light | HDD LED, Power LED (Green for Power, Yellow for HDD) |
| Expansion Slots | 2 x M.2 Slots: <ul style="list-style-type: none"> 1 x M.2 Key-E 2230 (PCIeIII x1, USB2.0 x1, CNVi) for Wi-Fi & BT Module (Support PCIe/USB Wi-Fi/BT module & CNVi Wi-Fi/BT module) 1 x M.2 Key-B 2242/3042/3052 with SIM card slot USB2.0 x1 SATA3/PCIeIII x1 (auto detect by switch IC) USB3.2 Gen 1x1 (5Gbp/s)/PCIeIII x1 (BOM option, default is USB3.2 Gen 1x1 (5Gbp/s)/ PCIeIII x 2 for NVMe) (3052 for 5G module) 1 x 80-pin Expansion IET interface |
| Others | HDD LED, Power LED (Green for Power, Yellow for HDD) |
| Mechanical | |
| Power Type | ATX/AT by jumper (Default ATX) |
| Power button | 1 x Power Switch on the side |

ARC-21W38

| | |
|------------------------------|--|
| Power Connector Type | Lockable DC in power jack (phoenix connector by option) |
| Dimension | 538.05 x 341.05 x 64mm |
| Weight | 7.3 Kgs |
| Color | Front: Die Casting with Cover lens; Rear: Black Die Casting |
| Fanless | Full System Fan-less |
| OS Support | Win 10/11, Linux |
| Reliability | |
| Dust and Rain Test | Front Panel IP65, Rear IP41 except I/O |
| Vibration Test | <p>Random Vibration Operation</p> <ul style="list-style-type: none"> • Test PSD : 0.00454G²/Hz , 1.5 Grms • System condition : operation mode • Test frequency : 5~500 Hz • Test axis : X,Y and Z axis • Test time : 30 minutes per each axis • IEC60068-2-64 Test Fh • Storage : SSD or M.2 SSD <p>Sine Vibration test (Non-operation)</p> <ul style="list-style-type: none"> • Test Acceleration : 2G • Test frequency : 5~500 Hz • Sweep : 1 Oct/ per one minute. (logarithmic) • Test Axis : X,Y and Z axis • Test time : 30 min. each axis • System condition : Non-Operating mode • Reference IEC 60068-2-6 Testing procedures <p>Package Vibration Test:</p> <ul style="list-style-type: none"> • Test PSD : 0.026G²/Hz , 2.16 Grms • Test frequency : 5~500 Hz • Test axis : X,Y and Z axis • Test time : 30 minutes per each axis • IEC 60068-2-64 Test Fh |
| Mechanical Shock Test | <ul style="list-style-type: none"> • Wave from : Half Sine wave • Acceleration Rate : 10g for operation mode • Duration Time : 11ms • No. of shock : Z axis 300 times • Test Axis : Z axis • Operation mode • Reference IEC 60068-2-27 testing procedures |

| | |
|--|--|
| | ➤ Test Eb : Shock Test |
| Drop Test | <p>Package drop test Reference ISTA 2A, Method : IEC-60068-2-32 Test:Ed Test Ea : Drop Test</p> <ul style="list-style-type: none"> • Test phase : One corner, three edges, six faces • Test high : 96.5cm • Package weight : 7.5 Kg • Test drawing |
| Operating Temperature | Standard temp. -10°C ~ 50°C (14°F ~ 122°F) |
| Operating Humidity | 40°C @ 95% Relative Humidity, Non-condensing |
| Storage Temperature | Standard temp.-20°C ~ 60°C (-4°F ~ 140°F) |
| Compliant with following Flexible Expansion Modules | |
| Optional IET Module list: | IET DB board description |
| ARC-BYT DB-A | 4 x USB 3.0 module |
| ARC-BYT DB-B | 3 x Audio Jack (Line in/Line out/Mic in) + HDMI |
| ARC-BYT DB-C | HDMI + Mini PCIe (w/ SIM slot) |
| ARC-BYT DB-D | 2 x COM Isolation module |
| ARC-BYT DB-G | 3 x COM (w/o isolation, RS-232 only) |
| ARC-BYT DB-H | 2COM (RS-232) + 1USB 2.0 |
| ARC-BYT DB-K | 2COM (RS-232) + 1LAN |
| ARC-BYT DB-E | 12-bit GPIO+CAN Bus |
| ARC-BYT DB-F | CAN Bus for OBDII (Small Vehicle) |
| ARC-BYT DB-F | CAN Bus for OBDII (Large Vehicle) |
| ARC-BYT DB-F | CAN Bus for OBDII (Special Large Vehicle) |



Note: Specifications are subject to change without notice.

1.4 System Overview

1.4.1 I/O View

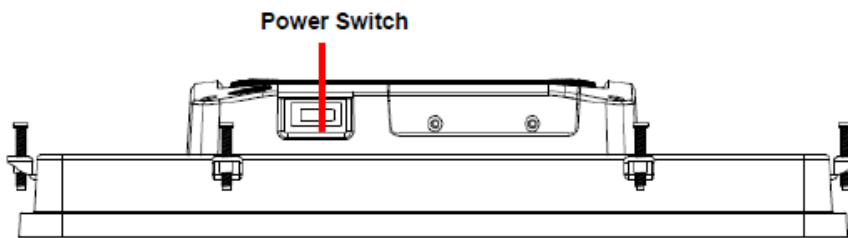
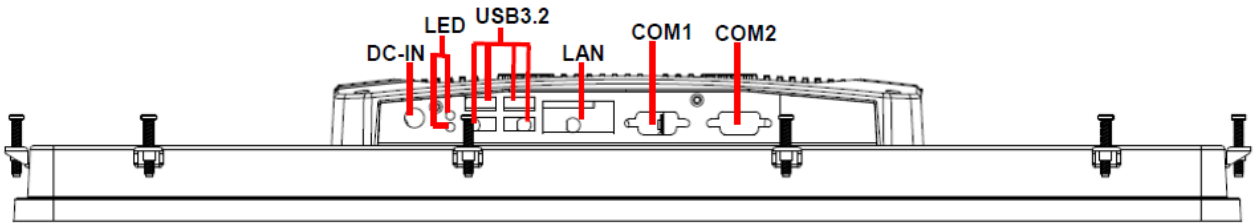

Connectors

| Label | Function | Note |
|--------------|---------------------------|---|
| DC-IN | DC Power-in connector | Default: Lockable DC Jack Option: Phoenix Connector(MOQ apply) |
| COM1/2 | Serial port 1/2 connector | DB-9 male connector |
| USB | 4 x USB 3.2 connector | |
| LAN | 2 x RJ-45 Ethernet | |
| LED | HDD/Power LED indicator | |
| Power Switch | Power on button | |

1.5 System Dimensions

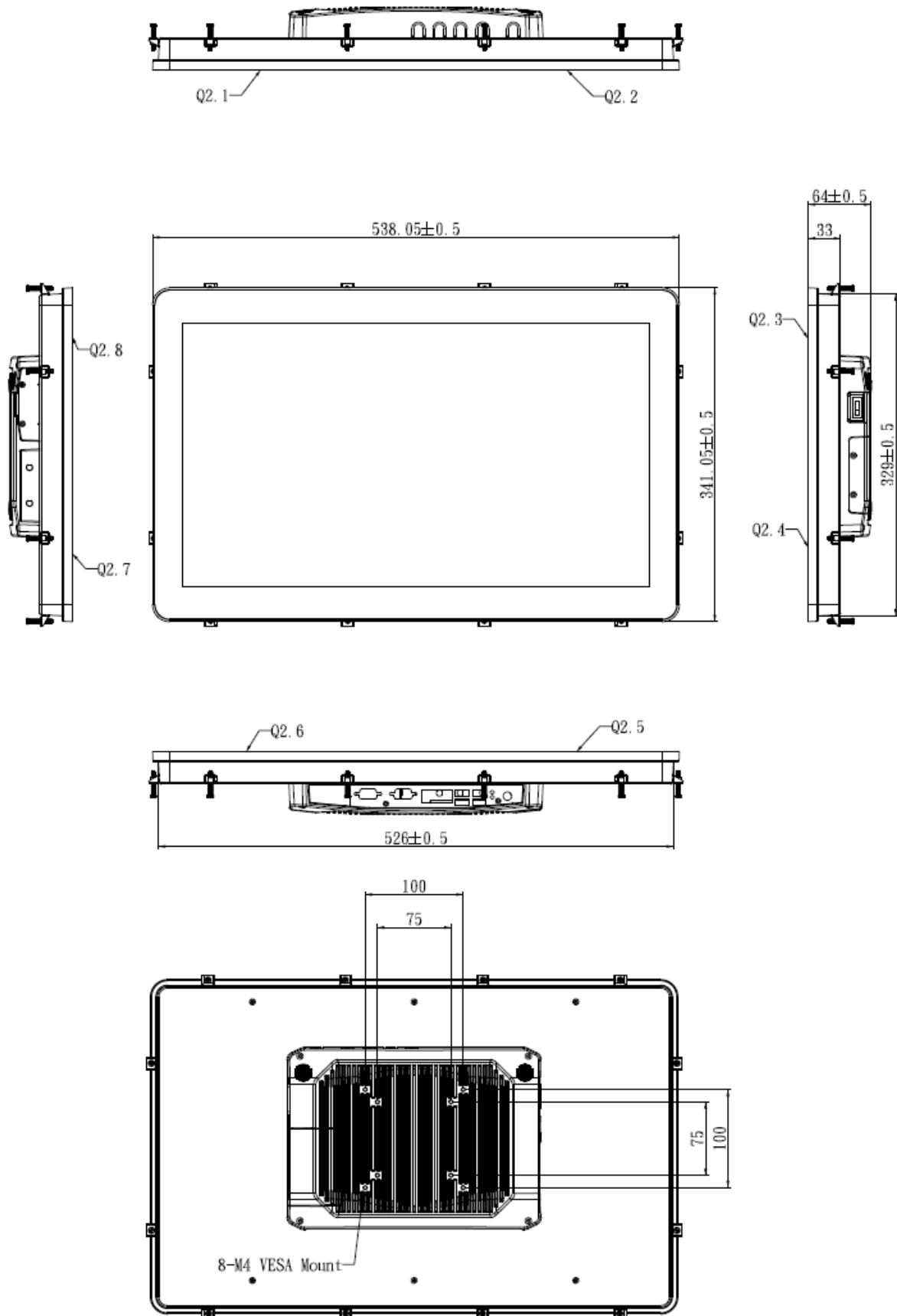

(Unit: mm)

2. Hardware Configuration

For advanced information, please refer to:

1- ARC-TGL, ARC-BYT DB-A/B/C/D/E/F/G/H/K included in this manual.



Note: If you need more information, please visit our website:

www.avalue.com.tw

2.1 ARC-21W38 connector mapping

2.1.1 Serial port 1 connector (COM1)

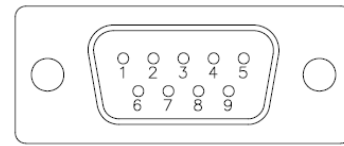
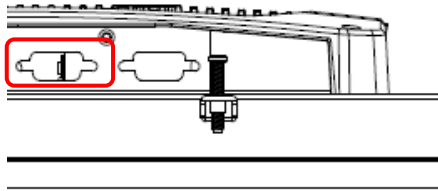

RS-232*

| Signal | PIN | PIN | Signal |
|--------|-----|-----|--------|
| NDCD# | 1 | 6 | NDSR# |
| NRXD | 2 | 7 | NRTS# |
| NTXD | 3 | 8 | NCTS# |
| NDTR# | 4 | 9 | NRI# |
| GND | 5 | | |

* Default

Note:

supports RS232 (BOM option for RS422/485)

RS-422(BOM option)

| Signal | PIN | PIN | Signal |
|--------|-----|-----|--------|
| TxD- | 1 | 6 | NC |
| TxD+ | 2 | 7 | NC |
| RxD+ | 3 | 8 | NC |
| RxD- | 4 | 9 | NC |
| GND | 5 | | |

RS-485(BOM option)

| Signal | PIN | PIN | Signal |
|--------|-----|-----|--------|
| DATA- | 1 | 6 | NC |
| DATA+ | 2 | 7 | NC |
| NC | 3 | 8 | NC |
| NC | 4 | 9 | NC |
| GND | 5 | | |

ARC-21W38

2.1.2 Serial port 2 connector (COM2)

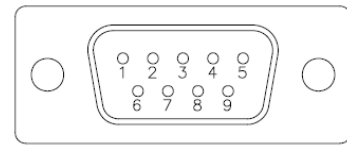
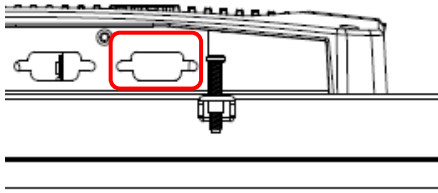

RS-232

| Signal | PIN | PIN | Signal |
|--------|-----|-----|--------|
| NDCD# | 1 | 6 | NDSR# |
| NRXD | 2 | 7 | NRTS# |
| NTXD | 3 | 8 | NCTS# |
| NDTR# | 4 | 9 | NRI# |
| GND | 5 | | |

2.2 Powering On the System

To power on the system, follow the steps below.

Step 1: Connect the power cord to the power adapter. Connect the other end of the power cord to a power source. Ensure to connect the power cord to a socket-outlet with earthing connection.

Step 2: Connect the power adapter to the power connector of the product.

Step 3: Locate the power button on the product.

Step 4: Switch on the power button can turn on the system. Keep holding the power button on can force shutdown the PC.

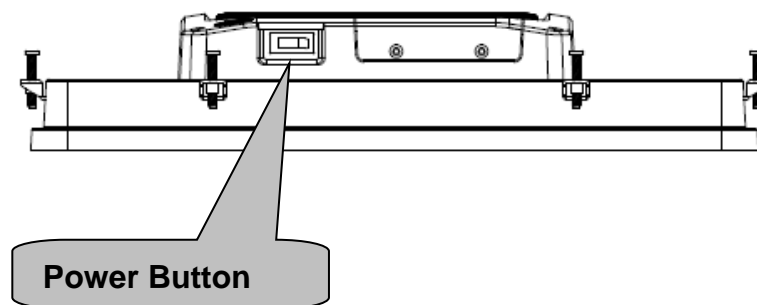
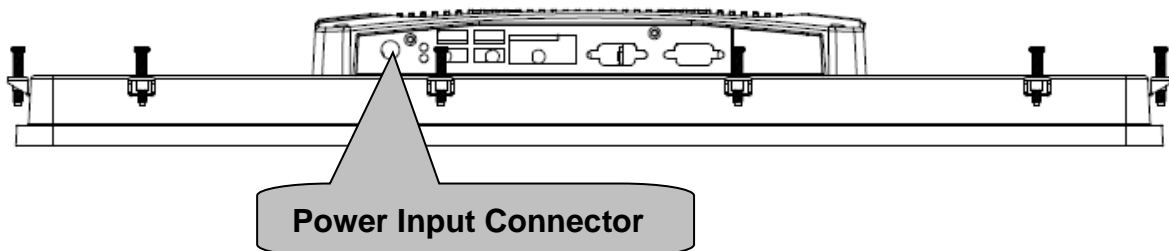

2.3 ARC-TGL Overview

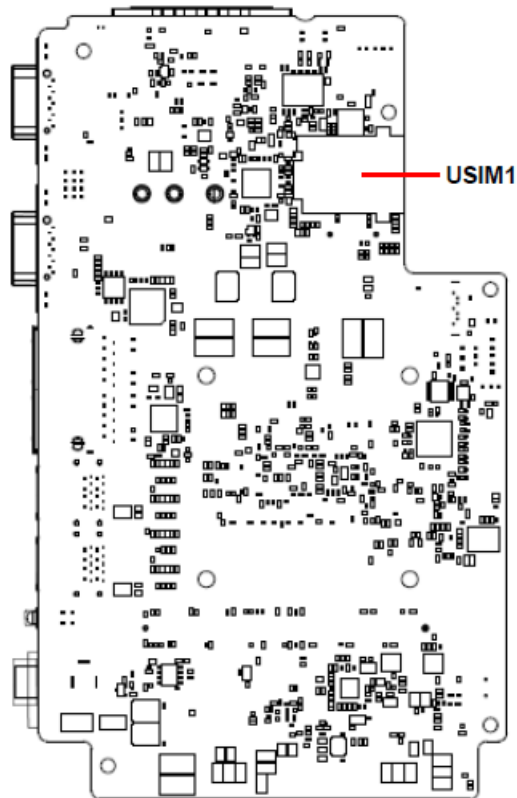
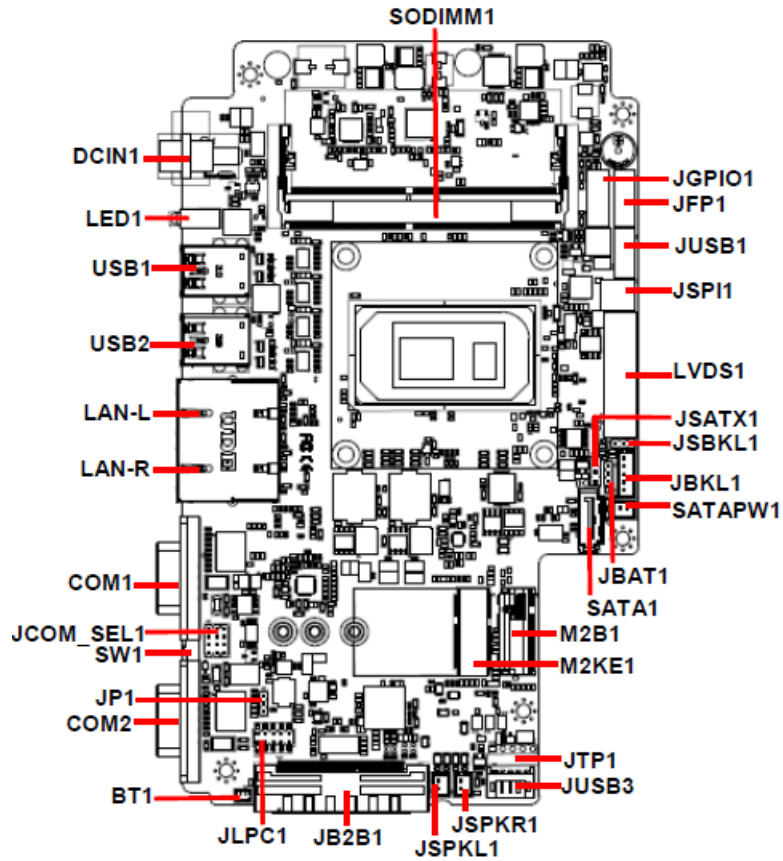

2.4 ARC-TGL Jumper and Connector List

You can configure your board to match the needs of your application by setting jumpers. A jumper is the simplest kind of electric switch.

It consists of two metal pins and a small metal clip (often protected by a plastic cover) that slides over the pins to connect them. To “close” a jumper you connect the pins with the clip. To “open” a jumper you remove the clip. Sometimes a jumper will have three pins, labeled 1, 2, and 3. In this case, you would connect either two pins.

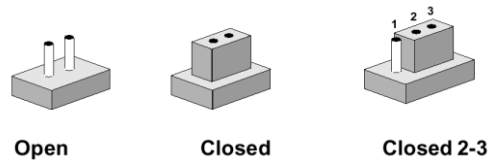

The jumper settings are schematically depicted in this manual as follows:



A pair of needle-nose pliers may be helpful when working with jumpers.

Connectors on the board are linked to external devices such as hard disk drives, a keyboard, or floppy drives. In addition, the board has a number of jumpers that allow you to configure your system to suit your application.

If you have any doubts about the best hardware configuration for your application, contact your local distributor or sales representative before you make any changes.

The following tables list the function of each of the board’s jumpers and connectors.

Jumpers

| Label | Function | Note |
|------------------|--------------------------------------|----------------------------|
| JBAT1 | Clear CMOS | 3 x 1 header, pitch 2.00mm |
| JP1 | M.2 KEY power select | 3 x 1 header, pitch 2.00mm |
| JCOM_SEL1 | Serial port 1 in RS-232/422/485 mode | 4 x 3 header, pitch 2.00mm |
| JSBKL1 | LCD backlight brightness adjustment | 3 x 1 header, pitch 2.00mm |
| JSATX1 | AT/ATX Input power select | 3 x 1 header, pitch 2.54mm |

Connectors

| Label | Function | Note |
|----------------|---------------------------|---------------------------|
| SODIMM1 | 260-Pin DDR4 SO-DIMM | |
| JBKL1 | LCD Inverter connector | 5 x 1 wafer, pitch 2.00mm |
| COM1/2 | Serial Port 1/2 connector | D-sub 9 pin, male |
| JSPKL1 | AMPLIFIER_L | 2 x 1 wafer, pitch 2.00mm |
| JSPKR1 | AMPLIFIER_R | 2 x 1 wafer, pitch 2.00mm |

ARC-21W38

| | | |
|------------------|------------------------------------|--------------------------------|
| JB2B1 | B2B connector | 40 x 2 wafer, pitch 0.80mm |
| LED1 | HDD/Power LED indicator | |
| LVDS1 | LVDS connector | DIN 40-pin wafer, pitch 1.25mm |
| USB1/2 | 4 x USB3.2 connector | |
| JUSB1 | On-board header for USB2.0 | 5 x 2 wafer, pitch 2.00mm |
| JUSB3 | On-board header for USB2.0 | 5 x 1 wafer, pitch 2.00mm |
| JTP1 | Touch connector | 5 x 1 header, pitch 2.54mm |
| LANL/LANR | 2 x RJ-45 Ethernet | |
| JFP1 | Front Panel connector | 6 x 2 wafer, pitch 2.00mm |
| BT1 | Battery connector | 2 x 1 wafer, pitch 1.25mm |
| JGPIO1 | General purpose I/O connector | 6 x 2 wafer, pitch 2.00mm |
| DCIN1 | DC-IN connector | |
| JSPI1 | SPI connector | 4 x 2 header, pitch 2.00mm |
| JLPC1 | LPC connector | 5 x 2 header, pitch 2.00 mm |
| SATA1 | Serial ATA connector | |
| SATAPW1 | SATA Power connector | 2 x 1 wafer, pitch 2.00mm |
| SW1 | Power button | |
| M2B1 | M.2 KEY-B 2242/3042/3052 connector | |
| M2KE1 | M.2 KEY-E 2230 connector | |
| USIM1 | SIM card slot | |

2.5 ARC-TGL Jumpers & Connectors settings

2.5.1 Clear CMOS (JBAT1)

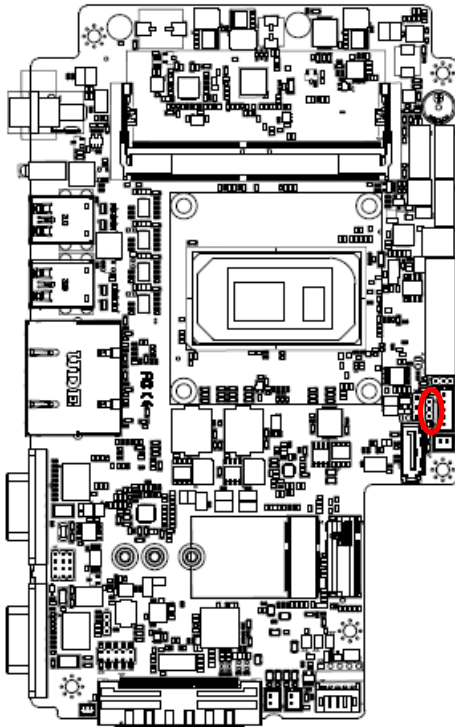

Protect*

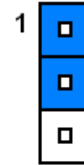

Clear CMOS

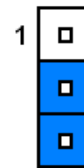

*Default

2.5.2 LCD backlight brightness adjustment (JSBKL1)

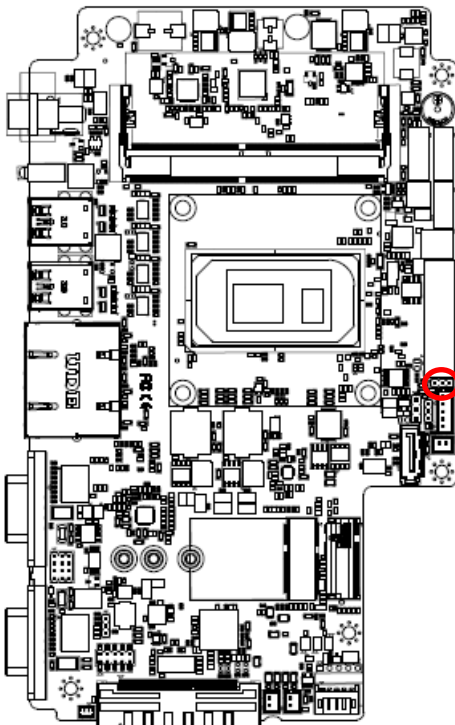

PWM Mode*

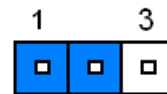

DC Mode

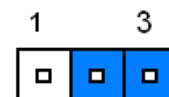

* Default

ARC-21W38

2.5.3 AT/ATX Input power select (JSATX1)

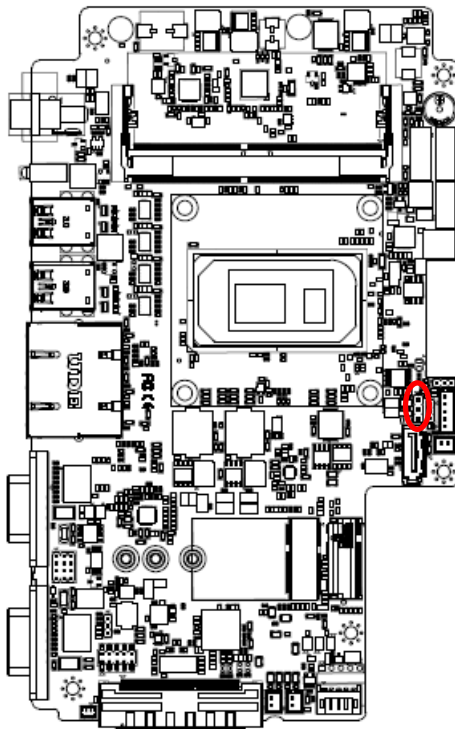

ATX*

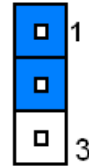

AT

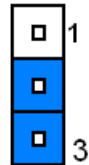

* Default

2.5.4 Serial port 1 in RS-232/422/485 mode (JCOM_SEL1)

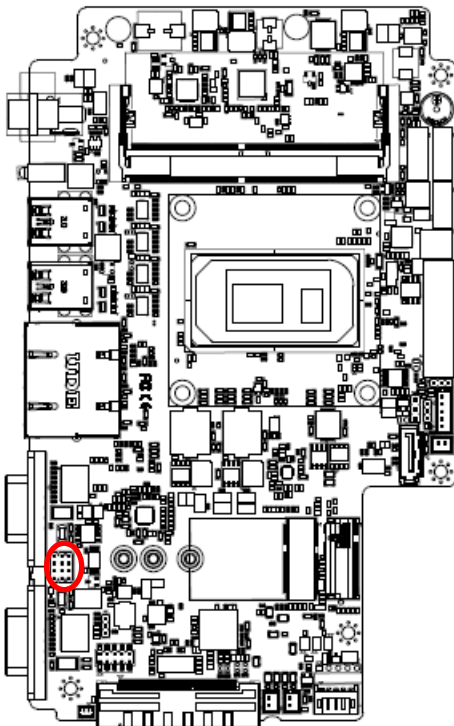

RS232*

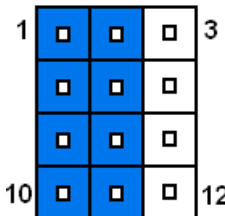

RS422

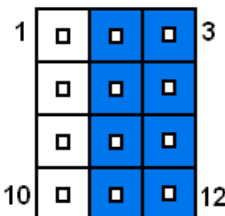

RS485

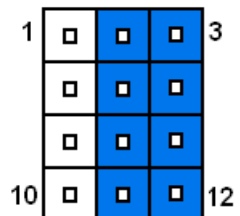

| PIN | Signal | PIN | Signal | PIN | Signal |
|-----|-------------|-----|--------|-----|--------|
| 12 | 422RX1- | 11 | COM1-4 | 10 | NDTRA# |
| 9 | 485_422TX1+ | 8 | COM1-2 | 7 | NRXDA |
| 6 | 422RX1+ | 5 | COM1-3 | 4 | NTXDA |
| 3 | 485_422TX1- | 2 | COM1-1 | 1 | NDCDA# |

Note:

This connector is available after modify the mode of COM1 in BIOS setting.

* Default

2.5.5 M.2 KEY power select (JP1)

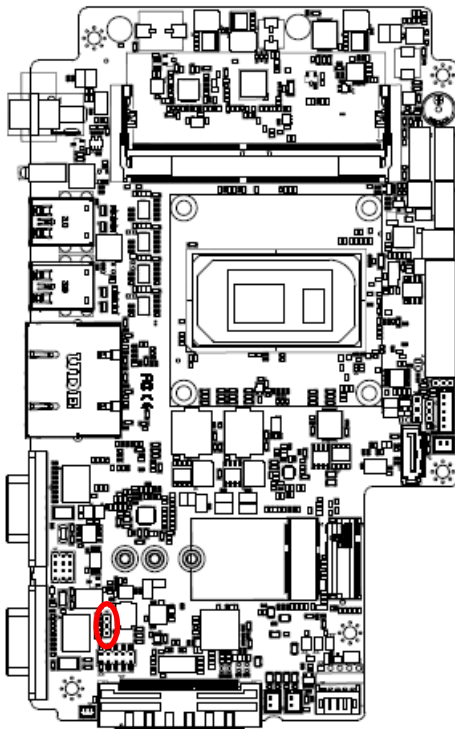

+3.8V

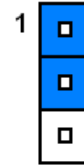

+3.3V*



*Default

2.5.6 LCD Inverter connector (JBKL1)

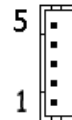
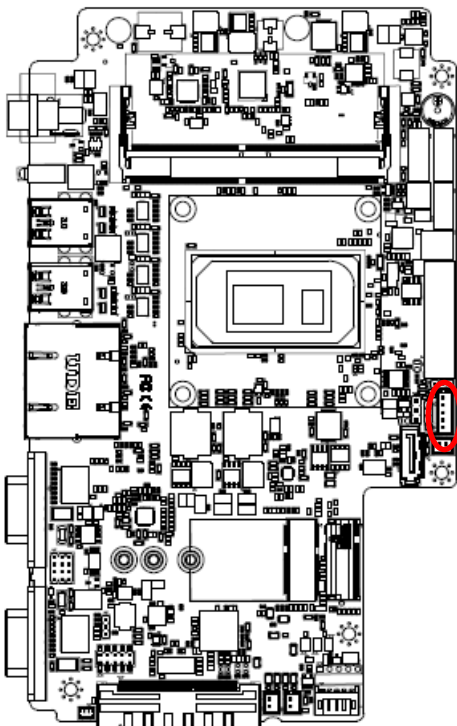

| Signal | PIN |
|--------------|-----|
| +5V | 5 |
| LVDS_BKLTCTL | 4 |
| LVDS_BKLT_EN | 3 |
| GND | 2 |
| +12V | 1 |

2.5.7 On-board header for USB2.0 (JUSB1)

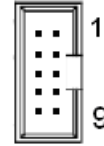
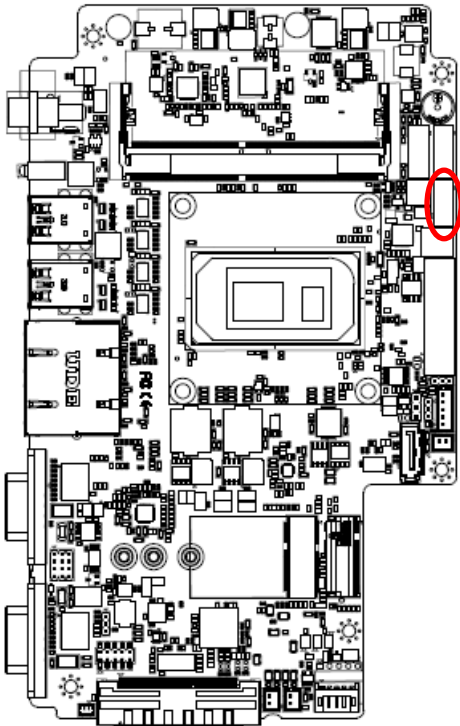

| Signal | PIN | PIN | Signal |
|------------|-----|-----|------------|
| +5VSB | 2 | 1 | +5VSB |
| USB2_R_DN6 | 4 | 3 | USB2_R_DN5 |
| USB2_R_DP6 | 6 | 5 | USB2_R_DP5 |
| GND | 8 | 7 | GND |
| GND | 10 | 9 | GND |

2.5.8 Touch connector (JTP1) co-lay USB2.0 header (JUSB3)

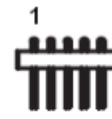
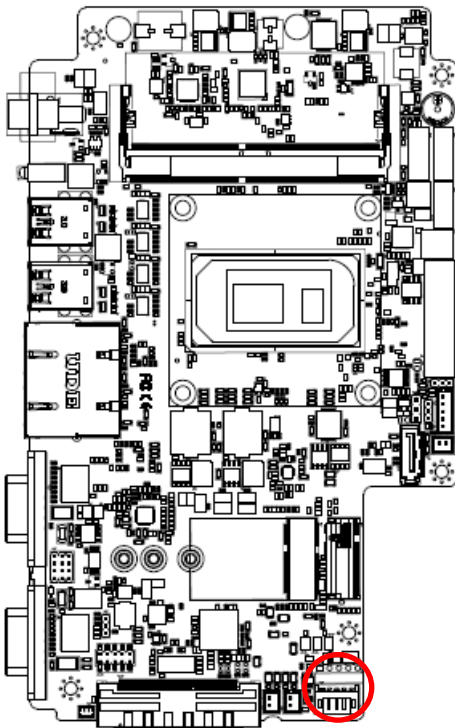

JTP1*

| Signal | PIN |
|--------|-----|
| X+ | 1 |
| X- | 2 |
| SENSE | 3 |
| Y+ | 4 |
| Y- | 5 |

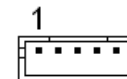

JUSB3

| Signal | PIN |
|-------------|-----|
| +5VSB | 1 |
| USB_WFR_PN8 | 2 |
| USB_WFR_PP8 | 3 |
| GND | 4 |
| GND | 5 |

*Default

2.5.9 LVDS connector (LVDS1)

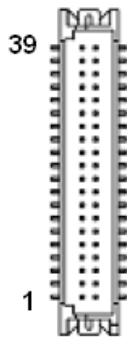
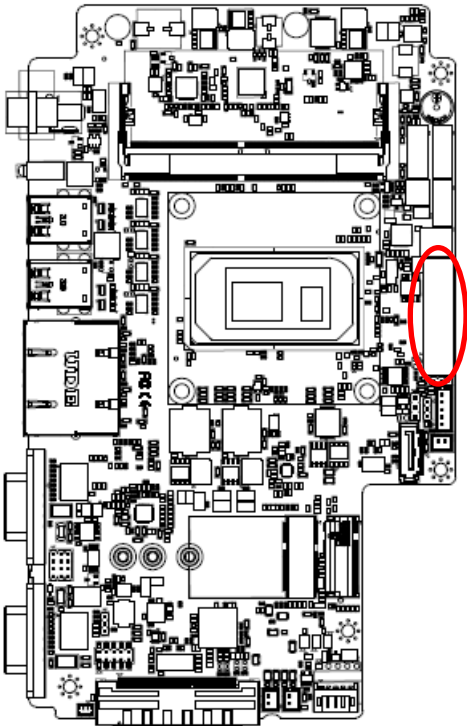

| Signal | PIN | PIN | Signal |
|---------------------------|-----|-----|---------------------------|
| +12V | 39 | 40 | +12V |
| GND | 37 | 38 | LVDS_GND/EDP_HPDP |
| LVDS_CLK2_N | 35 | 36 | LVDS_CLK1_N |
| LVDS_CLK2_P | 33 | 34 | LVDS_CLK1_P |
| GND | 31 | 32 | GND |
| LVDS_DATA7_N | 29 | 30 | LVDS_DATA6_N |
| LVDS_DATA7_P | 27 | 28 | LVDS_DATA6_P |
| GND | 25 | 26 | GND |
| LVDS_DATA5_N/ EDP_TXN2 | 23 | 24 | LVDS_DATA4_N |
| LVDS_DATA5_P/ EDP_TXP2 | 21 | 22 | LVDS_DATA4_P |
| GND | 19 | 20 | GND |
| LVDS_DATA3_N/ EDP_TXN1 | 17 | 18 | LVDS_DATA2_N/ EDP_AUXN |
| LVDS_DATA3_P/ EDP_TXP1 | 15 | 16 | LVDS_DATA2_P/ EDP_AUXP |
| GND | 13 | 14 | GND |
| LVDS_DATA1_N/ EDP_TXN0 | 11 | 12 | LVDS_DATA0_N/ EDP_TXN3 |
| LVDS_DATA1_P/ EDP_TXP0 | 9 | 10 | LVDS_DATA0_P/ EDP_TXP3 |
| GND | 7 | 8 | GND |
| LVDS_DDC_CLK_R | 5 | 6 | LVDS_DDC_DATA_R |
| VCC_LVDS/EDP | 3 | 4 | +5V |
| VCC_LVDS/EDP | 1 | 2 | +5V |

* Pin1 & 3 -- VCC_LVDS/EDP default 3.3V, BOM option 5/12V.

2.5.10 AMPLIFIER_R (JSPKR1)

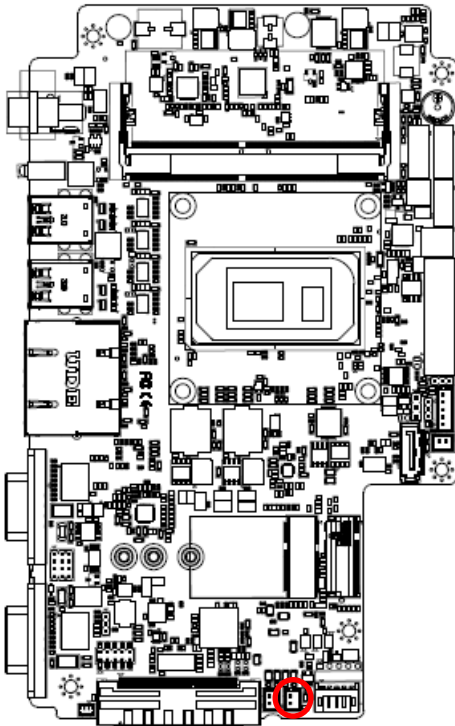

| Signal | PIN |
|--------|-----|
| SPK_R- | 2 |
| SPK_R+ | 1 |

2.5.11 AMPLIFIER_L (JSPKL1)

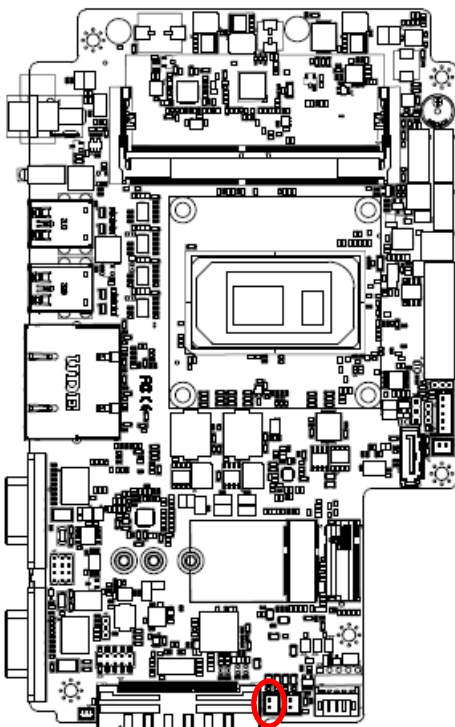

| Signal | PIN |
|--------|-----|
| SPK_L- | 2 |
| SPK_L+ | 1 |

2.5.12 Battery connector (BT1)

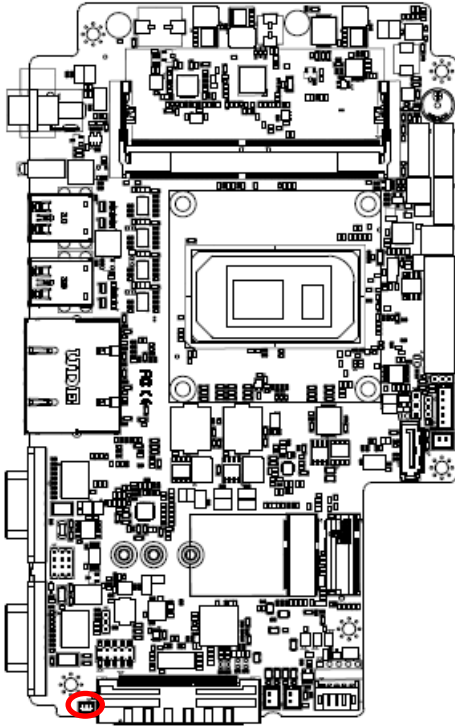

| Signal | PIN |
|----------|-----|
| +RTCBATT | 1 |
| GND | 2 |

2.5.13 SPI connector (JSPI1)

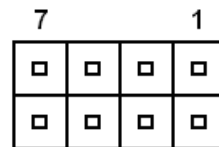
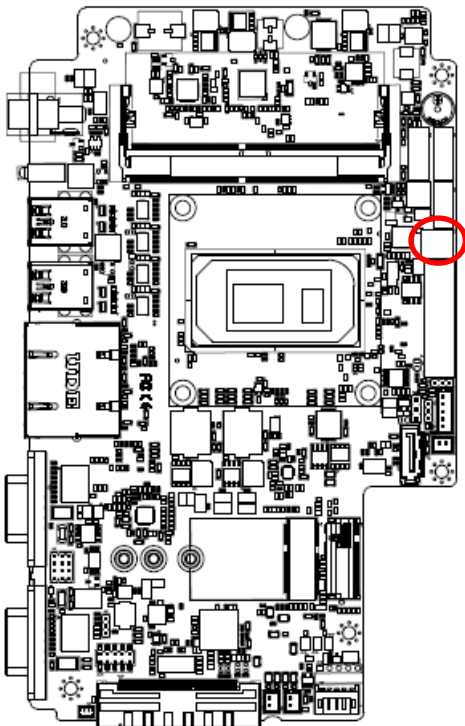

| Signal | PIN | PIN | Signal |
|----------------|-----|-----|----------------|
| +3.3VSB | 1 | 2 | GND |
| SPI0_CS0# | 3 | 4 | SPI0_BIOS_CLK |
| SPI0_BIOS_MISO | 5 | 6 | SPI0_BIOS_MOSI |
| BIOS_HOLD# | 7 | 8 | BIOS_WP# |

2.5.14 B2B connector (JB2B1)

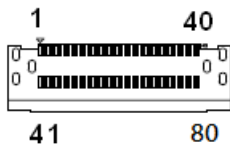
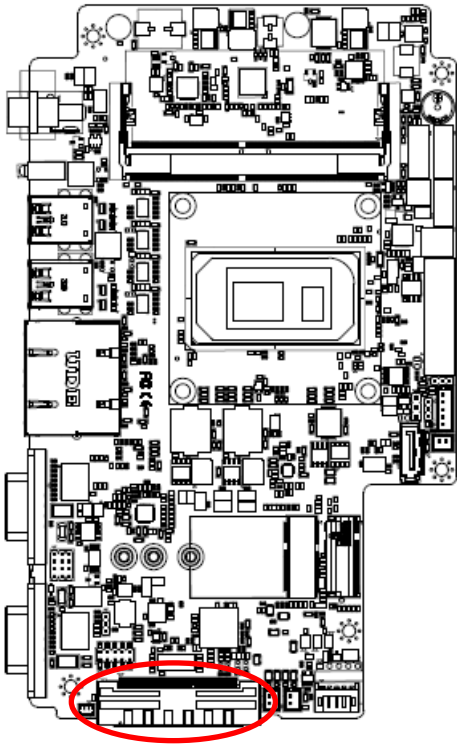

| Signal | PIN | PIN | Signal |
|-------------|-----|-----|--------|
| GND | 1 | 41 | GND |
| GND | 2 | 42 | GND |
| +12V | 3 | 43 | GND |
| +12V | 4 | 44 | GND |
| GND | 5 | 45 | GND |
| LPC_SERIRQ | 6 | 46 | +5VSB |
| LPC_LFRAME# | 7 | 47 | +5VSB |
| CLK_24M_B2B | 8 | 48 | +5VSB |
| LPC_AD0 | 9 | 49 | +5VSB |
| LPC_AD1 | 10 | 50 | +5VSB |

| Signal | PIN | PIN | Signal |
|----------------|-----|-----|--------------------|
| LPC_AD2 | 11 | 51 | GND |
| LPC_AD3 | 12 | 52 | B2B_USB2_DP7 |
| PS_ON_B2B | 13 | 53 | B2B_USB2_DN7 |
| PLT_BUF_RST# | 14 | 54 | GND |
| PCH_SLP_S3# | 15 | 55 | SMB_SCL_S0 |
| HDMI1_HPD_CONN | 16 | 56 | SMB_SDA_S0 |
| GND | 17 | 57 | GND |
| HDMI1_DDC_CLK | 18 | 58 | B2B_BOARD_ID |
| HDMI1_DDC_DAT | 19 | 59 | PCIEUSB3_PONRSTB |
| GND | 20 | 60 | PCIEUSB3_SMIB_INT# |
| HDMI1_TX_N2 | 21 | 61 | B2BPCIE_WAKE# |
| HDMI1_TX_P2 | 22 | 62 | RST_B2BPCIE# |
| GND | 23 | 63 | CLK_B2B_REQ2# |
| HDMI1_TX_N1 | 24 | 64 | GND |
| HDMI1_TX_P1 | 25 | 65 | PCIE_TXN8 |
| GND | 26 | 66 | PCIE_TXP8 |
| HDMI1_TX_N0 | 27 | 67 | GND |
| HDMI1_TX_P0 | 28 | 68 | PCIE_RXN8 |
| GND | 29 | 69 | PCIE_RXP8 |
| HDMI1_CLKN | 30 | 70 | GND |
| HDMI1_CLKP | 31 | 71 | CLK_B2B_N2 |
| GND | 32 | 72 | CLK_B2B_P2 |
| GND | 33 | 73 | GND |
| MICIN_R | 34 | 74 | GND |
| MICIN_L | 35 | 75 | MIC1_JD |
| GND | 36 | 76 | GND |
| LINEOUT1_JD | 37 | 77 | LINE1-JD |
| LINEOUT_R | 38 | 78 | LINEIN_R |
| LINEOUT_L | 39 | 79 | LINEIN_L |
| GND | 40 | 80 | GND |

2.5.15 General purpose I/O connector (JGPIO1)

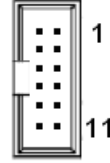
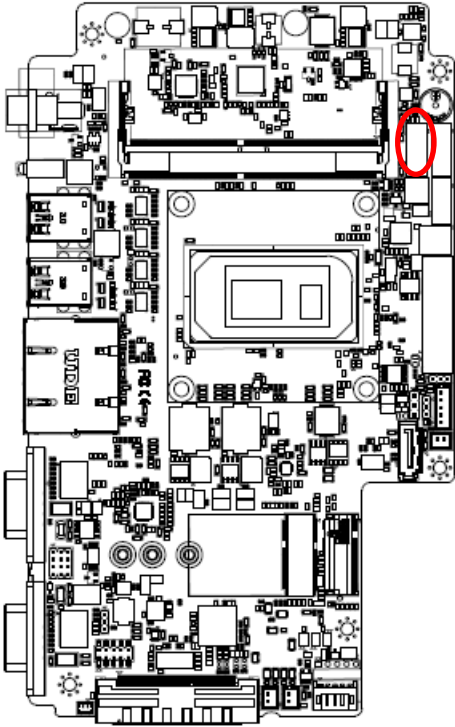

| Signal | PIN | PIN | Signal |
|------------|-----|-----|------------|
| DO0 | 2 | 1 | DI0 |
| DO1 | 4 | 3 | DI1 |
| DO2 | 6 | 5 | DI2 |
| DO3 | 8 | 7 | DI3 |
| SMB_SCL_S0 | 10 | 9 | SMB_SDA_S0 |
| GND | 12 | 11 | +3.3V |

2.5.16 SATA Power connector (SATAPW1)

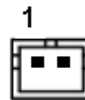
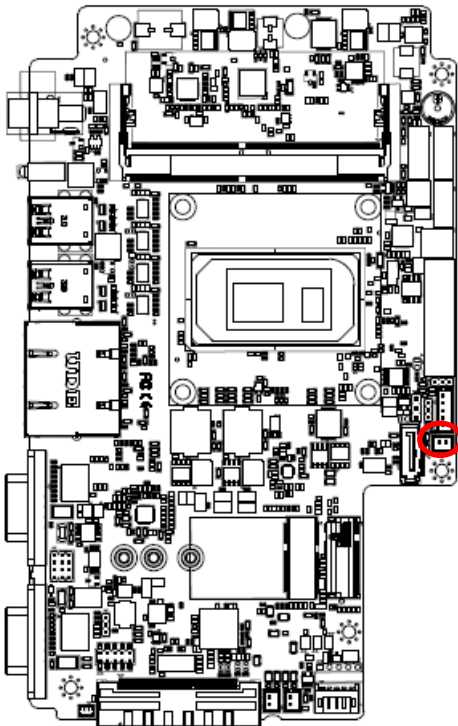

| Signal | PIN |
|--------|-----|
| GND | 1 |
| +5V | 2 |

ARC-21W38

2.5.17 LPC connector (JLPC1)

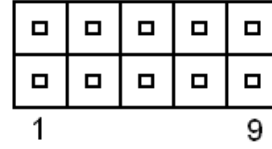
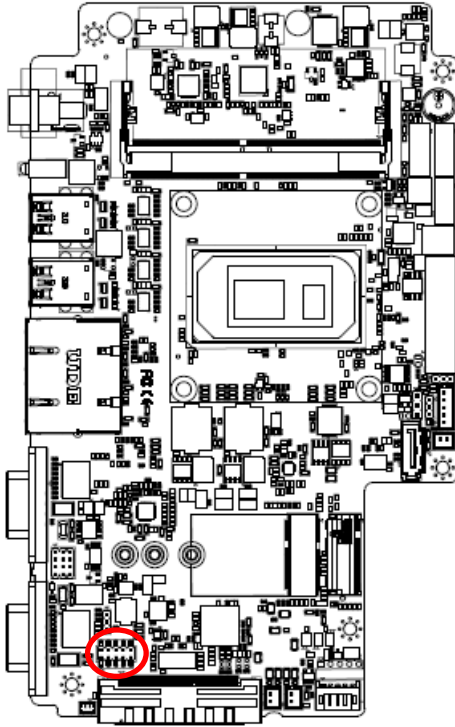

| Signal | PIN | PIN | Signal |
|------------|-----|-----|--------------|
| LPC_AD0 | 1 | 2 | +3.3V |
| LPC_AD1 | 3 | 4 | PLT_BUF_RST# |
| LPC_AD2 | 5 | 6 | LPC_LFRAME# |
| LPC_AD3 | 7 | 8 | CLK_24M_80 |
| LPC_SERIRQ | 9 | 10 | GND |

2.5.18 Front Panel connector (JFP1)

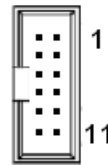
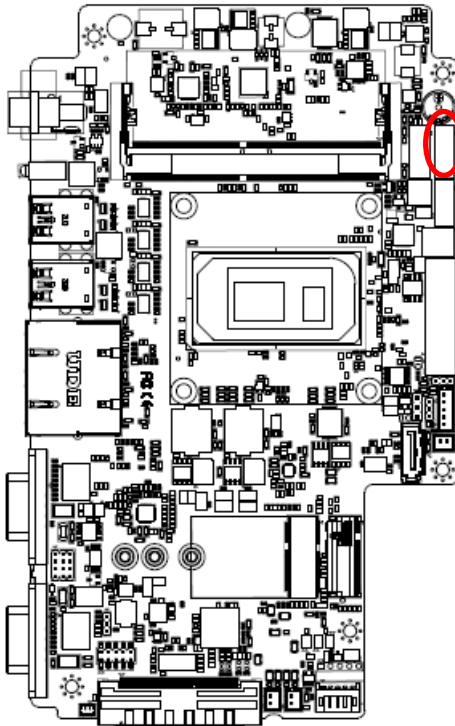

| Signal | PIN |
|-----------|-----|
| PWBT | 1 |
| | 2 |
| RST# | 3 |
| | 4 |
| PWR-LED- | 5 |
| PWR-LED+ | 6 |
| HDD-LED- | 7 |
| HDD-LED+ | 8 |
| LAN1-LED- | 9 |
| LAN1-LED+ | 10 |
| LAN2-LED- | 11 |
| LAN2-LED+ | 12 |

2.6 ARC-BYT DB-A/B/C/D/E/F/G/H/K Overviews

2.6.1 ARC-BYT DB-A

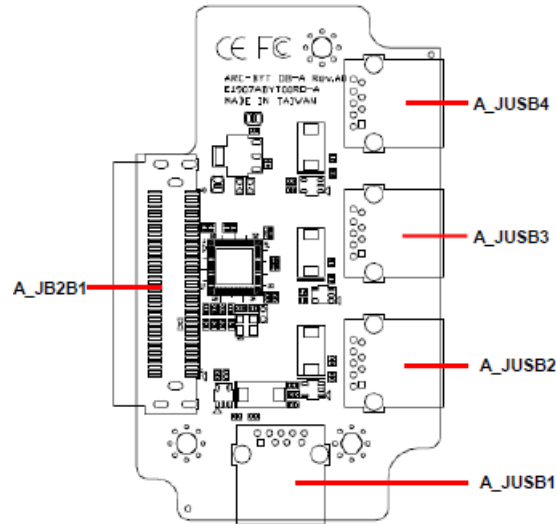

2.6.2 ARC-BYT DB-B

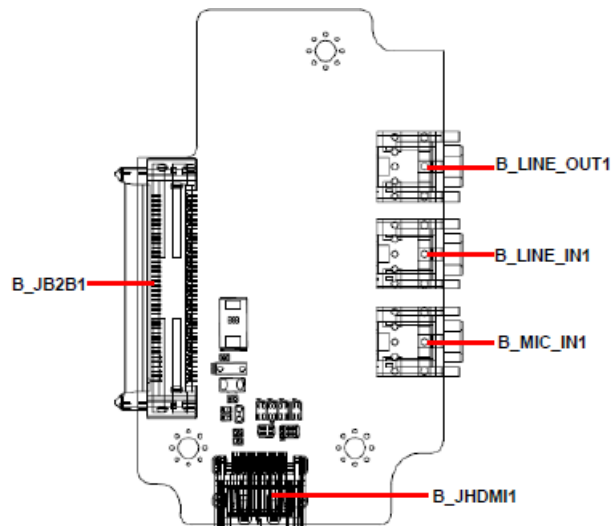

2.6.3 ARC-BYT DB-C

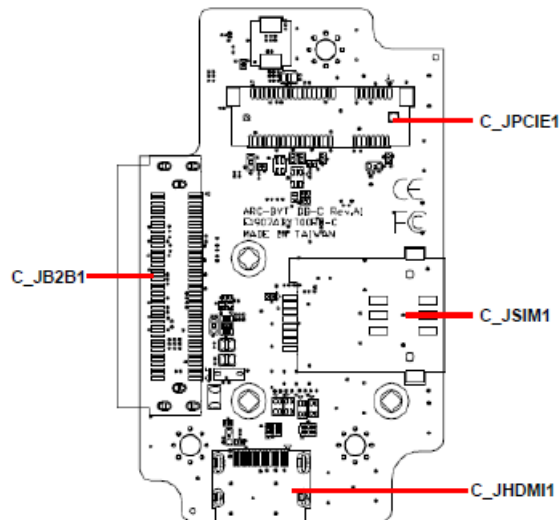

ARC-21W38

2.6.4 ARC-BYT DB-D

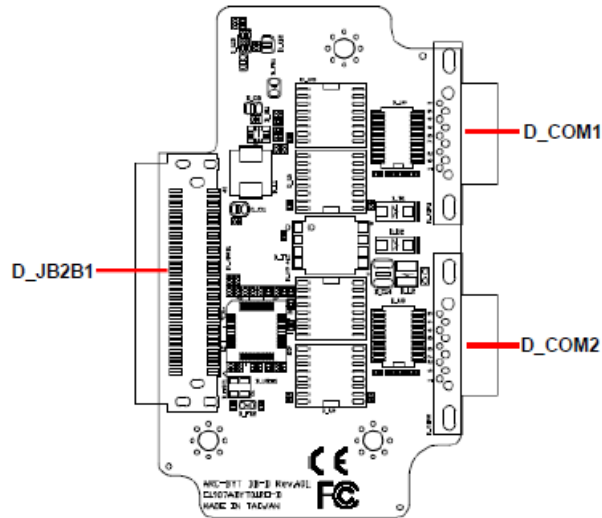

2.6.5 ARC-BYT DB-E

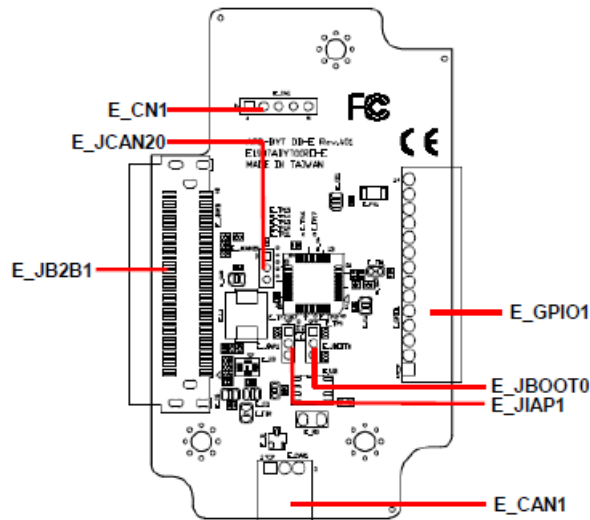

2.6.6 ARC-BYT DB-F

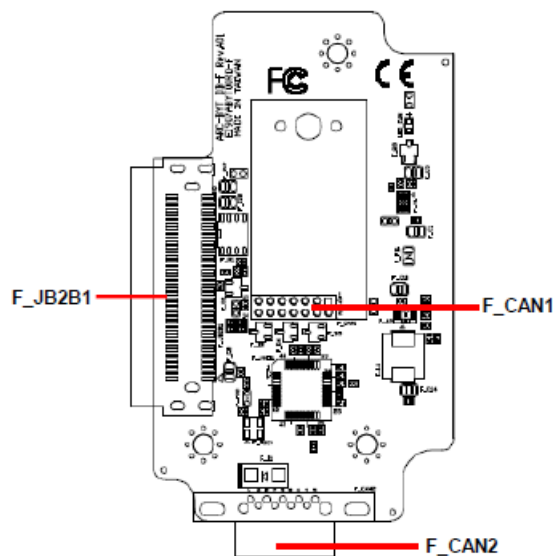

2.6.7 ARC-BYT DB-G

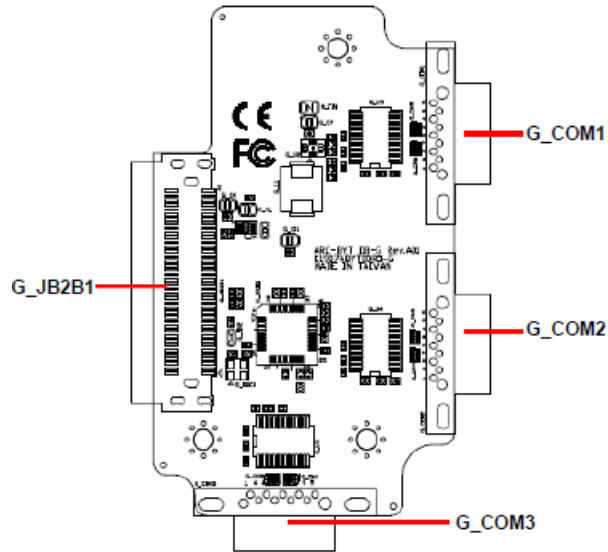

2.6.8 ARC-BYT DB-H

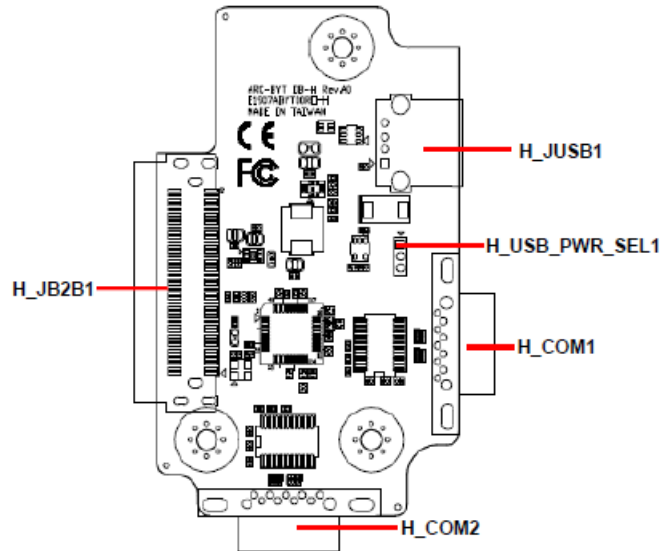

2.6.9 ARC-BYT DB-K

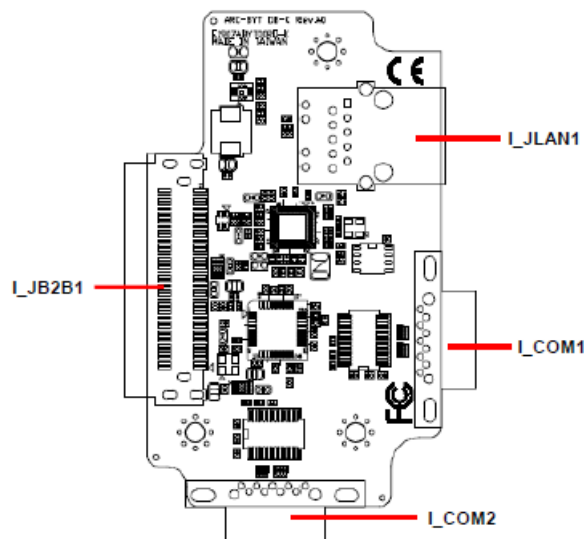

2.7 ARC-BYT DB-A/B/C/D/E/F/G/H/K Connector list

2.7.1 ARC-BYT DB-A

Connectors

| Label | Function | Note |
|-----------|----------------------|------|
| A_JUSB1~4 | USB3.0 connector 1~4 | |
| A_JB2B1 | B2B connector | |

2.7.2 ARC-BYT DB-B

Connectors

| Label | Function | Note |
|-------------|---------------------|------|
| B_LINE_OUT1 | Line-out audio jack | |
| B_LINE_IN1 | Line-in audio jack | |
| B_MIC_IN1 | Mic-in audio jack | |
| B_JHDMI1 | HDMI connector | |
| B_JB2B1 | B2B connector | |

2.7.3 ARC-BYT DB-C

Connectors

| Label | Function | Note |
|----------|----------------------------|------|
| C_JPCIE1 | Mini PCI Express connector | |
| C_JSIM1 | SIM card slot (Push-push) | |
| C_JHDMI1 | HDMI connector | |
| C_JB2B1 | B2B connector | |

2.7.4 ARC-BYT DB-D

Connectors

| Label | Function | Note |
|----------|---------------------------|---------------------|
| D_COM1/2 | Serial Port 1/2 connector | DB-9 male connector |
| D_JB2B1 | B2B connector | |

2.7.5 ARC-BYT DB-E

Jumpers

| Label | Function | Note |
|----------|--------------------|----------------------------|
| E_JCAN20 | CAN2.0 Switch | 3 x 1 header, pitch 2.00mm |
| E_JIAP1 | For user update FW | 3 x 1 header, pitch 2.00mm |
| E_JBOOT0 | For user update FW | 3 x 1 header, pitch 2.00mm |

Connectors

| Label | Function | Note |
|---------|-------------------------------|-------------------------------|
| E_GPIO1 | General purpose I/O connector | 14 x 1 terminal, pitch 2.50mm |
| E_CN1 | For user update FW | 5 x 1 header, pitch 2.54mm |
| E_CAN1 | CAN Bus connector | 3 x 1 terminal, pitch 2.50mm |
| E_JB2B1 | B2B connector | |

2.7.6 ARC-BYT DB-F**Connectors**

| Label | Function | Note |
|---------|---------------------|----------------------------|
| F_CAN1 | CAN Bus connector 1 | 7 x 2 header, pitch 2.00mm |
| F_CAN2 | CAN Bus connector 2 | |
| F_JB2B1 | B2B connector | |

2.7.7 ARC-BYT DB-G**Connectors**

| Label | Function | Note |
|------------|-----------------------------|---------------------|
| G_COM1/2/3 | Serial Port 1/2/3 connector | DB-9 male connector |
| G_JB2B1 | B2B connector | |

2.7.8 ARC-BYT DB-H**Jumpers**

| Label | Function | Note |
|----------------|--------------------|----------------------------|
| H_USB_PWR_SEL1 | USB Power selector | 3 x 1 header, pitch 2.00mm |

Connectors

| Label | Function | Note |
|----------|---------------------------|---------------------|
| H_JUSB1 | USB3.0 connector | |
| H_COM1/2 | Serial Port 1/2 connector | DB-9 male connector |
| H_JB2B1 | B2B connector | |

2.7.9 ARC-BYT DB-K**Connectors**

| Label | Function | Note |
|---------|----------------|------|
| I_JLAN1 | RJ-45 Ethernet | |

ARC-21W38

| | | |
|-----------------|---------------------------|---------------------|
| I_COM1/2 | Serial Port 1/2 connector | DB-9 male connector |
| I_JB2B1 | B2B connector | |

2.8 ARC-BYT DB-D Connectors settings

2.8.1 Serial Port 1 connector (D_COM1)

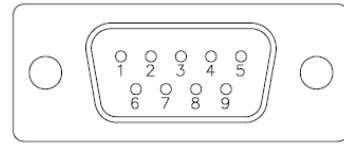
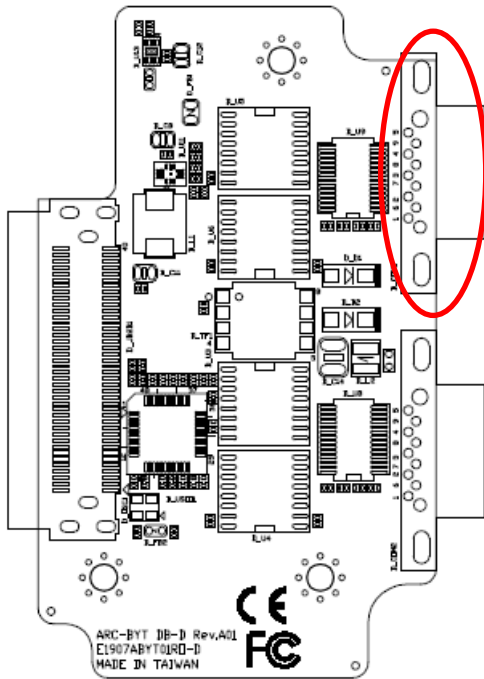

| Signal | PIN | PIN | Signal |
|-----------|-----|-----|-----------|
| NDCD#_3_D | 1 | 6 | NDSR#_3_D |
| NRXD_3_D | 2 | 7 | NRTS#_3_D |
| NTXD_3_D | 3 | 8 | NCTS#_3_D |
| NDTR#_3_D | 4 | 9 | NRI#_3_D |
| GND | 5 | | |

2.8.2 Serial Port 2 connector (D_COM2)

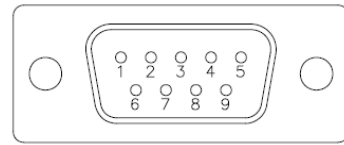
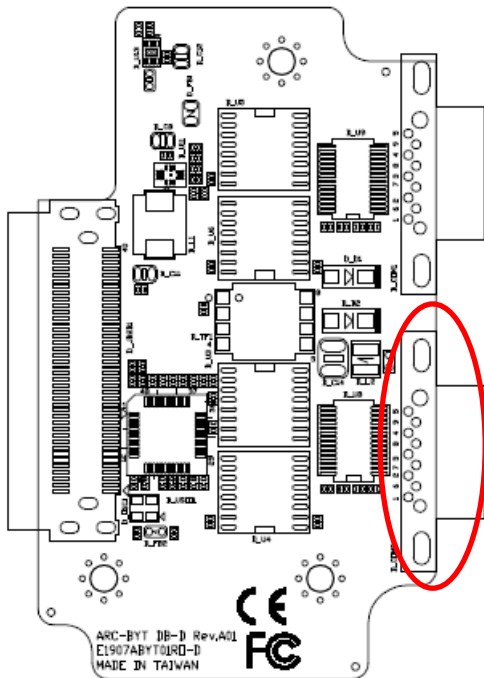

| Signal | PIN | PIN | Signal |
|-----------|-----|-----|-----------|
| NDCD#_2_D | 1 | 6 | NDSR#_2_D |
| NRXD_2_D | 2 | 7 | NRTS#_2_D |
| NTXD_2_D | 3 | 8 | NCTS#_2_D |
| NDTR#_2_D | 4 | 9 | NRI#_2_D |
| GND | 5 | | |

2.9 ARC-BYT DB-E Jumpers & Connectors settings

2.9.1 CAN2.0 Switch (E_JCAN20)

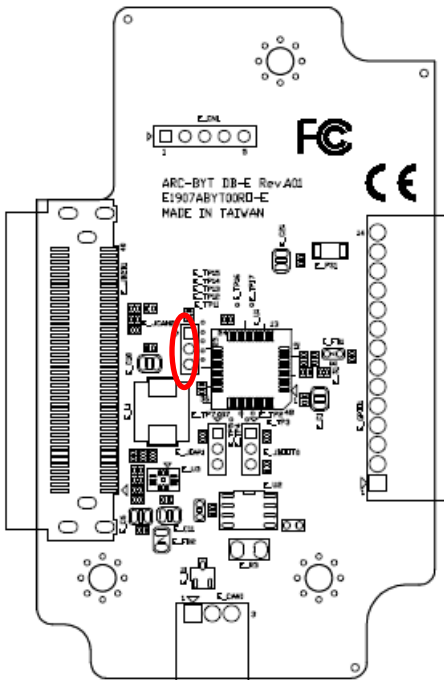

CAN2.0A (11-bit)*

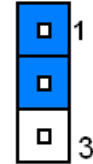

CAN2.0B (29-bit)

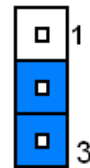

*Default

2.9.2 For user update FW (E_JBOOT0)

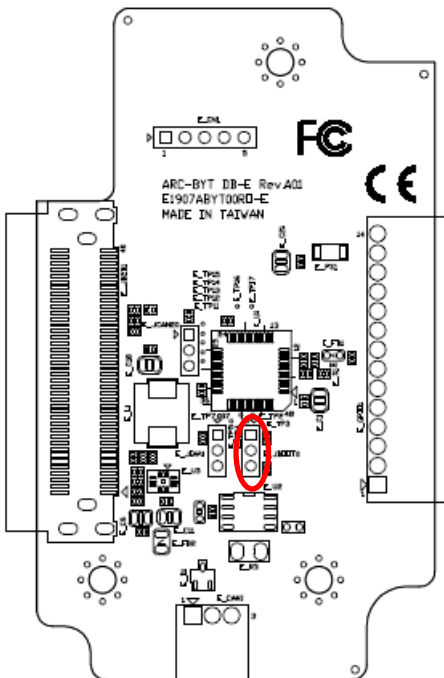

Default*

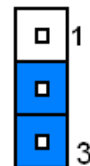

For user update FW

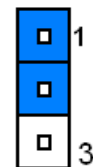

*Default

2.9.3 For user update FW (E_JIAP1)

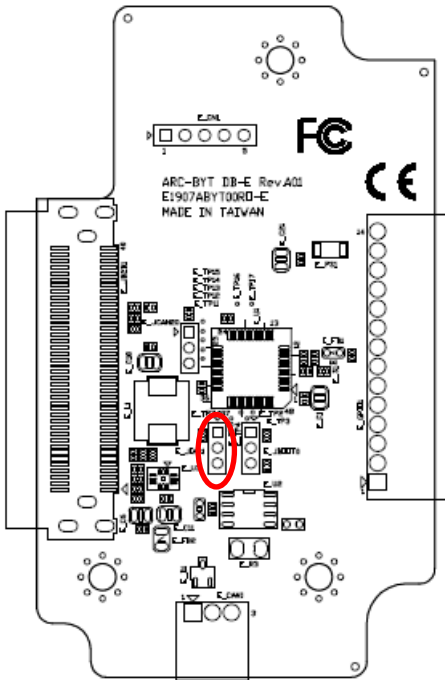

Default*

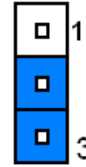

For user update FW

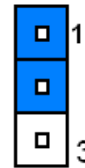

*Default

2.9.4 For user update FW (E_CN1)

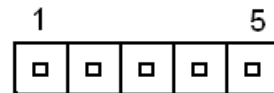
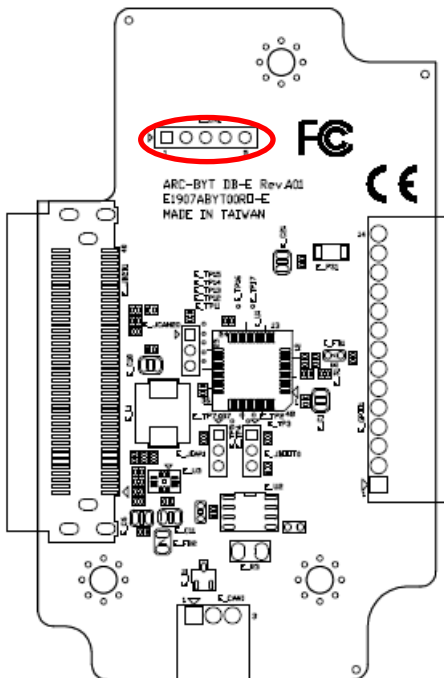

| Signal | PIN |
|----------------|-----|
| +3.3V | 1 |
| SWDIO | 2 |
| SWCLK | 3 |
| CAN_BUS_RESET# | 4 |
| GND | 5 |

2.9.5 General purpose I/O connector (E_GPIO1)

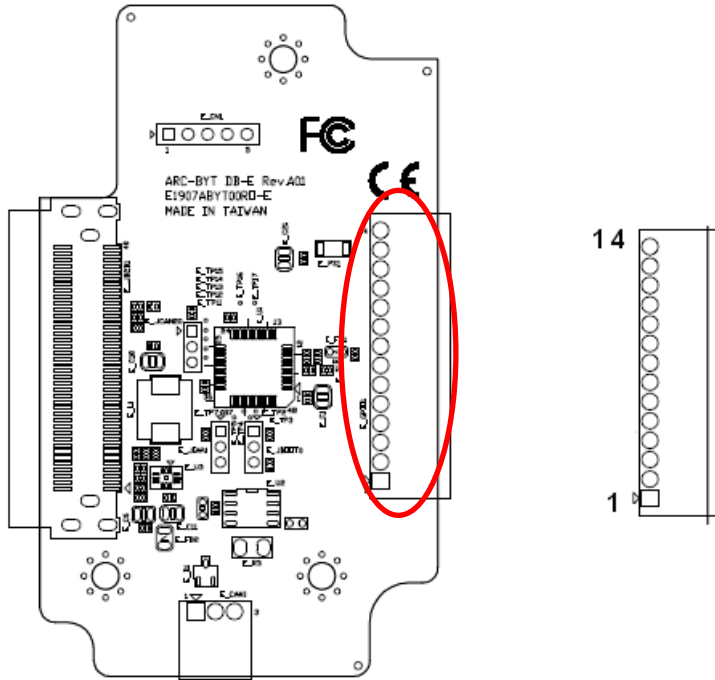

| Signal | PIN |
|--------|-----|
| GND | 14 |
| +3.3V | 13 |
| DO5 | 12 |
| DO4 | 11 |
| DO3 | 10 |
| DO2 | 9 |
| DO1 | 8 |
| DO0 | 7 |
| DI5 | 6 |
| DI4 | 5 |
| DI3 | 4 |
| DI2 | 3 |
| DI1 | 2 |
| DI0 | 1 |

2.9.6 CAN Bus connector (E_CAN1)

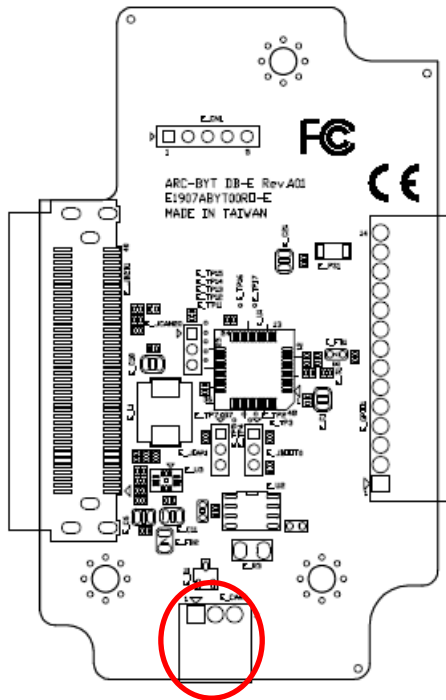

| Signal | PIN |
|--------|-----|
| CANH | 1 |
| CANL | 2 |
| GND | 3 |

2.10 ARC-BYT DB-F Connectors settings

2.10.1 CAN Bus connector 1 (F_CAN1)

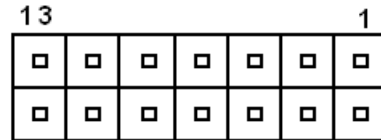
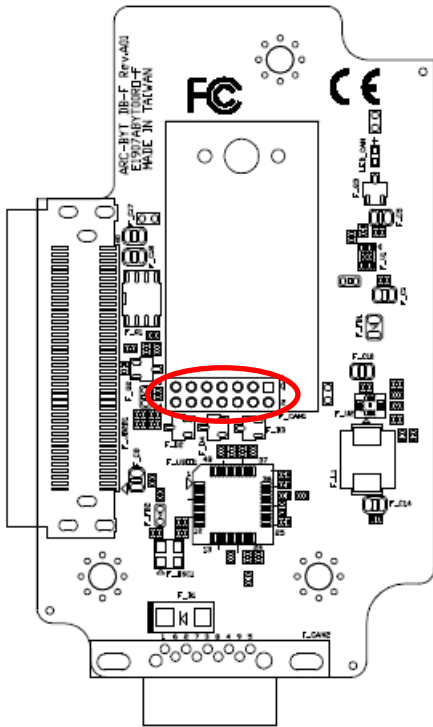

| Signal | PIN | PIN | Signal |
|--------------|-----|-----|---------|
| CAN_PWR | 1 | 2 | CAN_8 |
| CAN_IND | 3 | 4 | CAN_9 |
| GND | 5 | 6 | BAT_GND |
| CAN_WAKE | 7 | 8 | CAN_11 |
| UART_RXD_1_F | 9 | 10 | CAN_12 |
| UART_TXD_1_F | 11 | 12 | CAN_13 |
| +5V | 13 | 14 | CAN_14 |

2.10.2 CAN Bus connector 2 (F_CAN2)

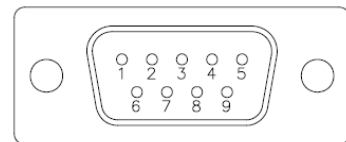
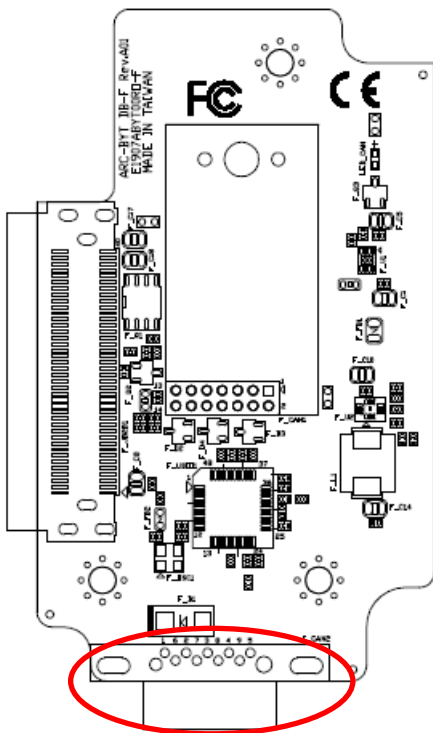

| Signal | PIN | PIN | Signal |
|---------|-----|-----|--------|
| BAT_PWR | 1 | 6 | CAN_12 |
| CAN_8 | 2 | 7 | CAN_13 |
| CAN_9 | 3 | 8 | CAN_14 |
| BAT_GND | 4 | 9 | NC |
| CAN_11 | 5 | | |

2.11 ARC-BYT DB-G Connectors settings

2.11.1 Serial Port 1 connector (G_COM1)

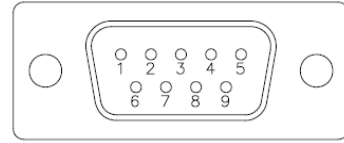
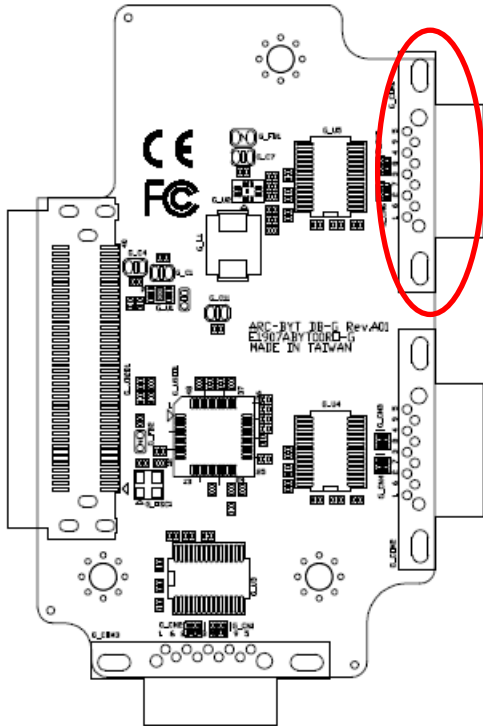

| Signal | PIN | PIN | Signal |
|-----------|-----|-----|-----------|
| NDCD#_3_G | 1 | 6 | NDSR#_3_G |
| NRXD_3_G | 2 | 7 | NRTS#_3_G |
| NTXD_3_G | 3 | 8 | NCTS#_3_G |
| NDTR#_3_G | 4 | 9 | NRI#_3_G |
| GND | 5 | | |

2.11.2 Serial Port 2 connector (G_COM2)

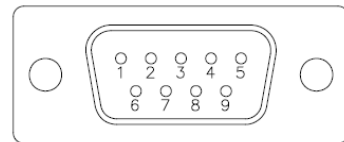
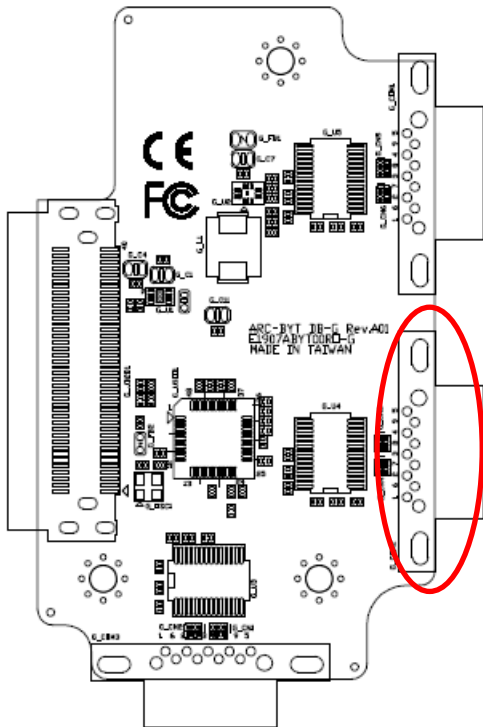

| Signal | PIN | PIN | Signal |
|-----------|-----|-----|-----------|
| NDCD#_2_G | 1 | 6 | NDSR#_2_G |
| NRXD_2_G | 2 | 7 | NRTS#_2_G |
| NTXD_2_G | 3 | 8 | NCTS#_2_G |
| NDTR#_2_G | 4 | 9 | NRI#_2_G |
| GND | 5 | | |

2.11.3 Serial Port 3 connector (G_COM3)

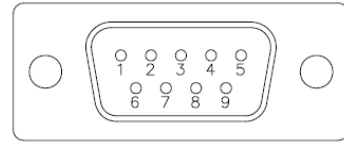
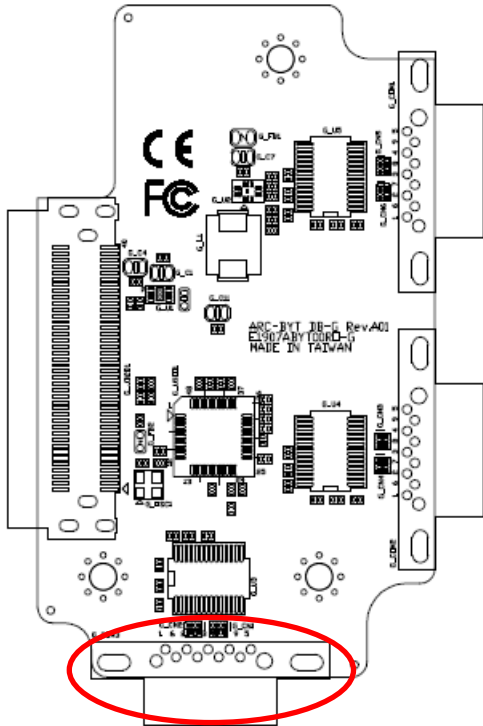

| Signal | PIN | PIN | Signal |
|-----------|-----|-----|-----------|
| NDCD#_1_G | 1 | 6 | NDSR#_1_G |
| NRXD_1_G | 2 | 7 | NRTS#_1_G |
| NTXD_1_G | 3 | 8 | NCTS#_1_G |
| NDTR#_1_G | 4 | 9 | NRI#_1_G |
| GND | 5 | | |

2.12 ARC-BYT DB-H Jumpers settings

2.12.1 USB Power selector (H_USB_PWR_SEL1)

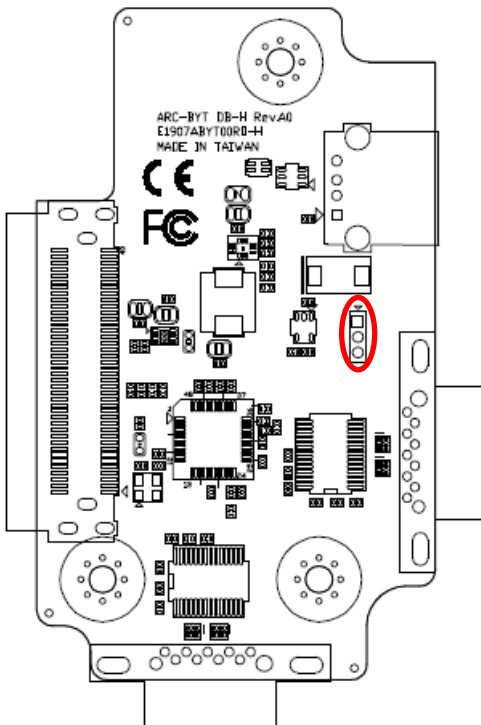

+5VSB*

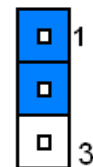

+5V

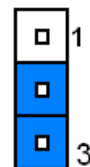

*Default

2.13 ARC-BYT DB-H Connectors settings

2.13.1 Serial Port 1 connector (H_COM1)

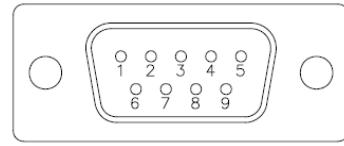
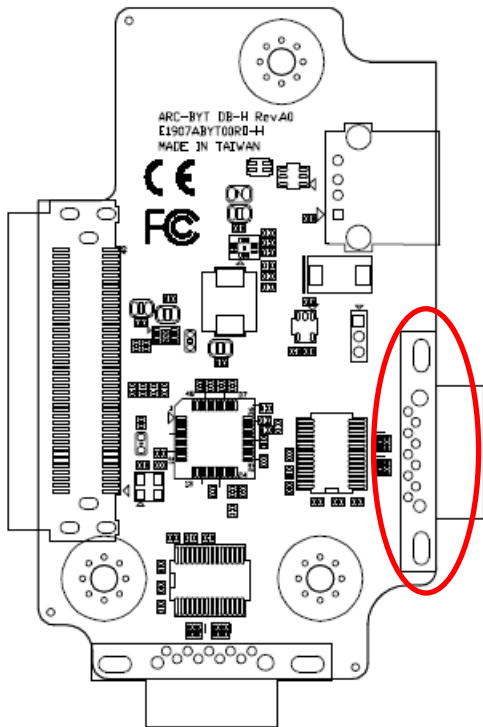

| Signal | PIN | PIN | Signal |
|-----------|-----|-----|-----------|
| NDCD#_1_H | 1 | 6 | NDSR#_1_H |
| NRXD_1_H | 2 | 7 | NRTS#_1_H |
| NTXD_1_H | 3 | 8 | NCTS#_1_H |
| NDTR#_1_H | 4 | 9 | NRI#_1_H |
| GND | 5 | | |

2.13.2 Serial Port 2 connector (H_COM2)

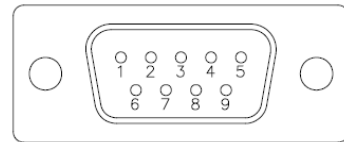
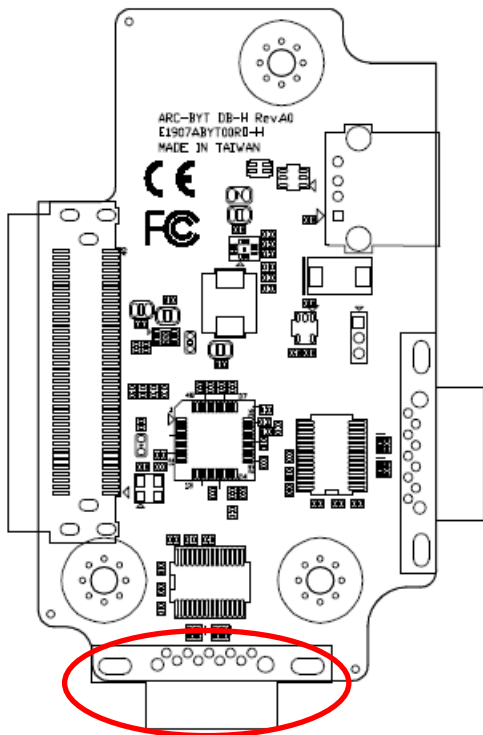

| Signal | PIN | PIN | Signal |
|-----------|-----|-----|-----------|
| NDCD#_2_H | 1 | 6 | NDSR#_2_H |
| NRXD_2_H | 2 | 7 | NRTS#_2_H |
| NTXD_2_H | 3 | 8 | NCTS#_2_H |
| NDTR#_2_H | 4 | 9 | NRI#_2_H |
| GND | 5 | | |

2.14 ARC-BYT DB-K Connectors settings

2.14.1 Serial Port 1 connector (I_COM1)

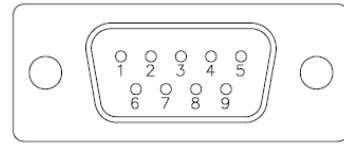
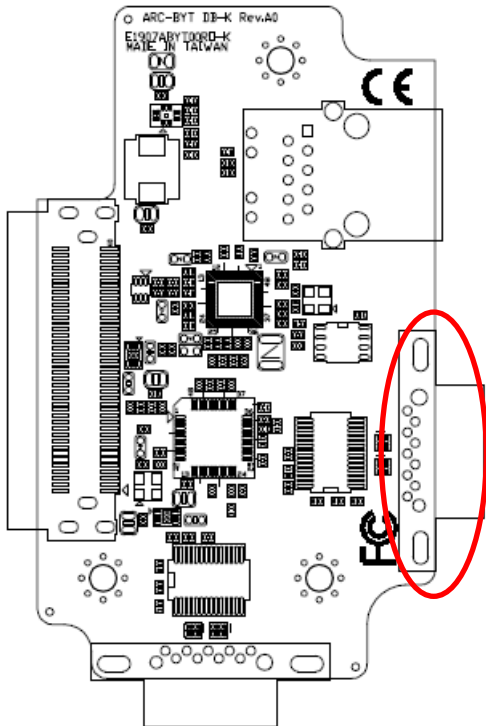

| Signal | PIN | PIN | Signal |
|-----------|-----|-----|-----------|
| NDCD#_1_I | 1 | 6 | NDSR#_1_I |
| NRXD_1_I | 2 | 7 | NRTS#_1_I |
| NTXD_1_I | 3 | 8 | NCTS#_1_I |
| NDTR#_1_I | 4 | 9 | NRI#_1_I |
| GND | 5 | | |

2.14.2 Serial Port 2 connector (I_COM2)

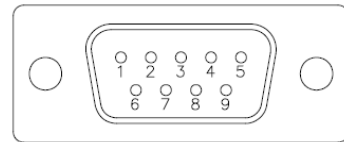
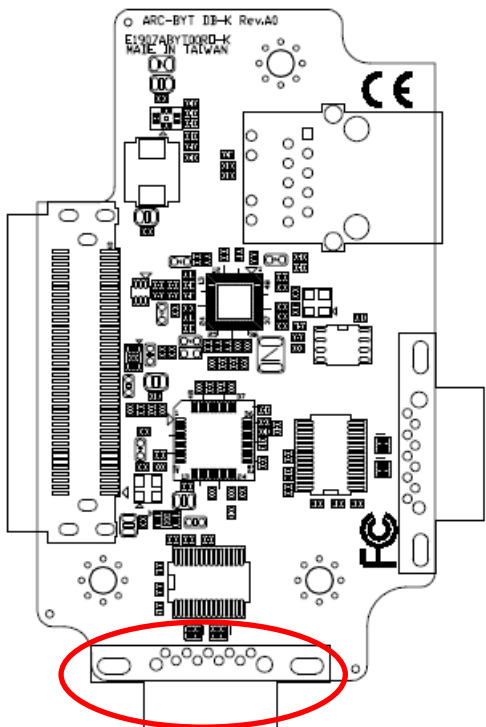

| Signal | PIN | PIN | Signal |
|-----------|-----|-----|-----------|
| NDCD#_2_I | 1 | 6 | NDSR#_2_I |
| NRXD_2_I | 2 | 7 | NRTS#_2_I |
| NTXD_2_I | 3 | 8 | NCTS#_2_I |
| NDTR#_2_I | 4 | 9 | NRI#_2_I |
| GND | 5 | | |

3. Installation



Removing the Top Cover Warning

To prevent electric shock or system damage, before removing the chassis cover, must turn off power and disconnect the unit from power source.

Electrostatic discharge (ESD) can cause serious damage to electronic components. Dry climates are especially susceptible to ESD. It is therefore critical that whenever the product is accessed internally, or any other electrical component is handled, the following anti-static precautions are strictly adhered to:

- Wear an anti-static wristband: Wearing a simple anti-static wristband can help to prevent ESD from damaging the board.
- Self-grounding: Before handling the board, touch any grounded conducting material. During the time the board is handled, frequently touch any conducting materials that are connected to the ground.
- Use an anti-static pad: When configuring the product, place it on an anti-static pad. This reduces the possibility of ESD damaging the product.
- Only handle the edges of the PCB: When handling the PCB, hold the PCB by the edges.

Installation Precautions

When installing the flat bezel panel PC, please follow the precautions listed below:

- Power turned off: When installing the flat bezel panel PC, make sure the power is off. Failing to turn off the power may cause severe injury to the body and/or damage to the system.
- Certified Engineers: Never open the equipment. For safety reasons, the equipment should be opened only by qualified skilled person.
- Anti-static Discharge: If a user open the rear panel of the flat bezel panel PC, to configure the jumpers or plug in added peripheral devices, ground themselves first and wear an anti-static wristband.

3.1 Installing Memory

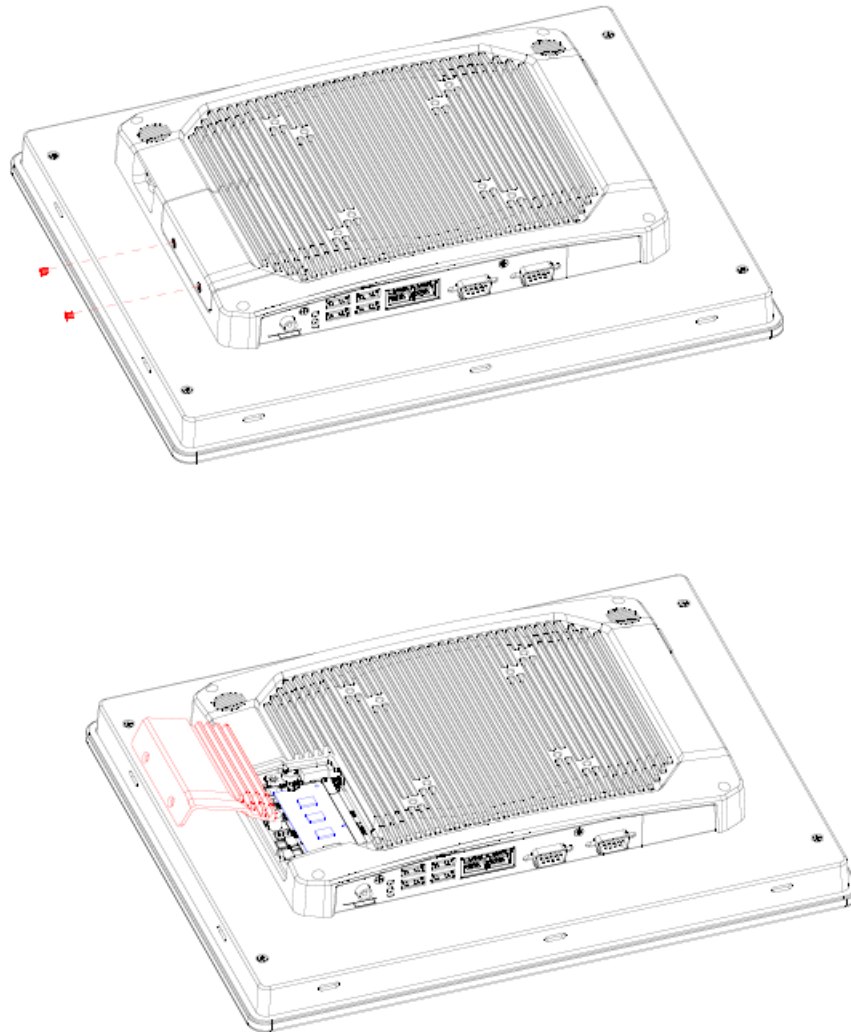

Step 1. Remove 2 screws to release the chassis cover and remove it.

Step 2. Slide the DDR4 SODIMM into the memory socket and press it down until properly seated.

3.2 Installing SSD

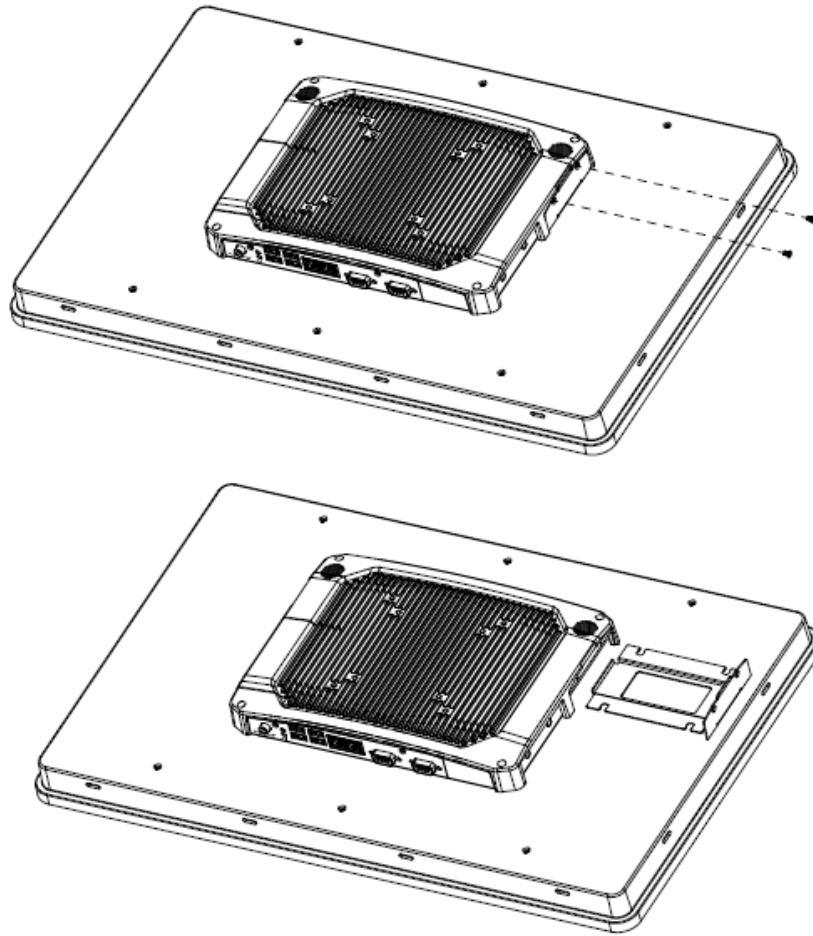

Step 1. Unfasten 2 screws of the SSD bracket and take it off.

Step 2. Insert the SSD into the socket and fasten 2 screws.

3.3 Installing ARC-BYT DB

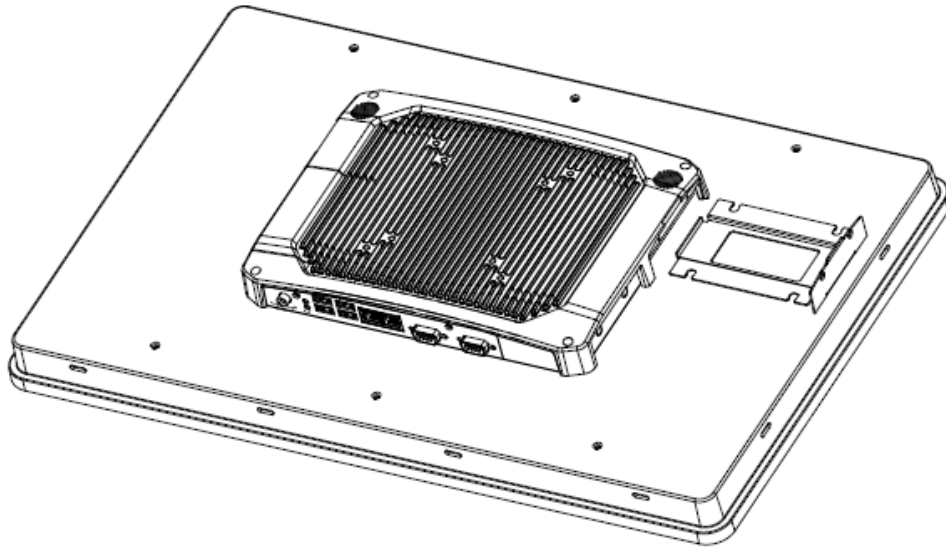

Step 1. Unfasten 2 screws of the HDD bracket and take it off.

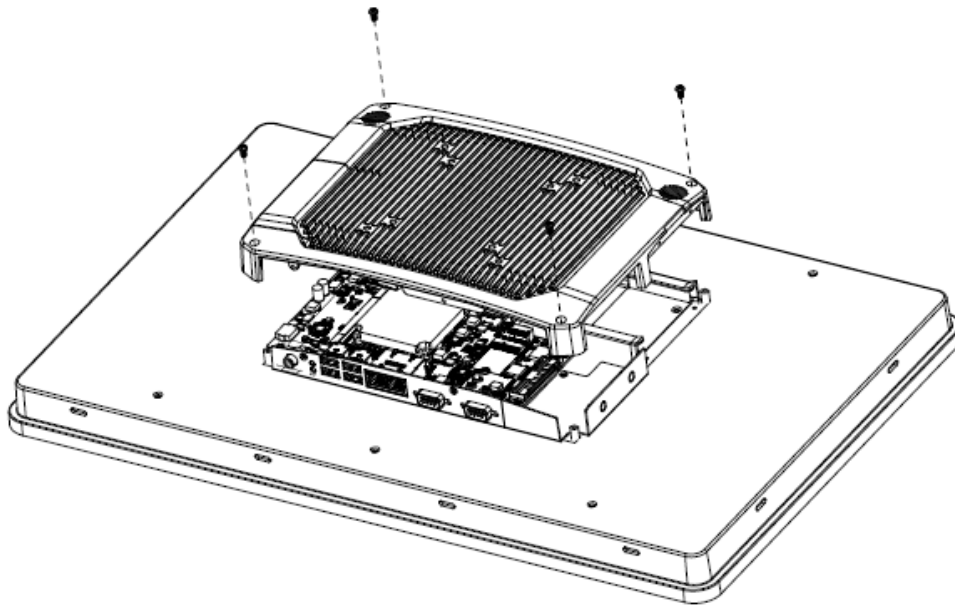

Step 2. Remove 4 screws to release the chassis cover and remove it.

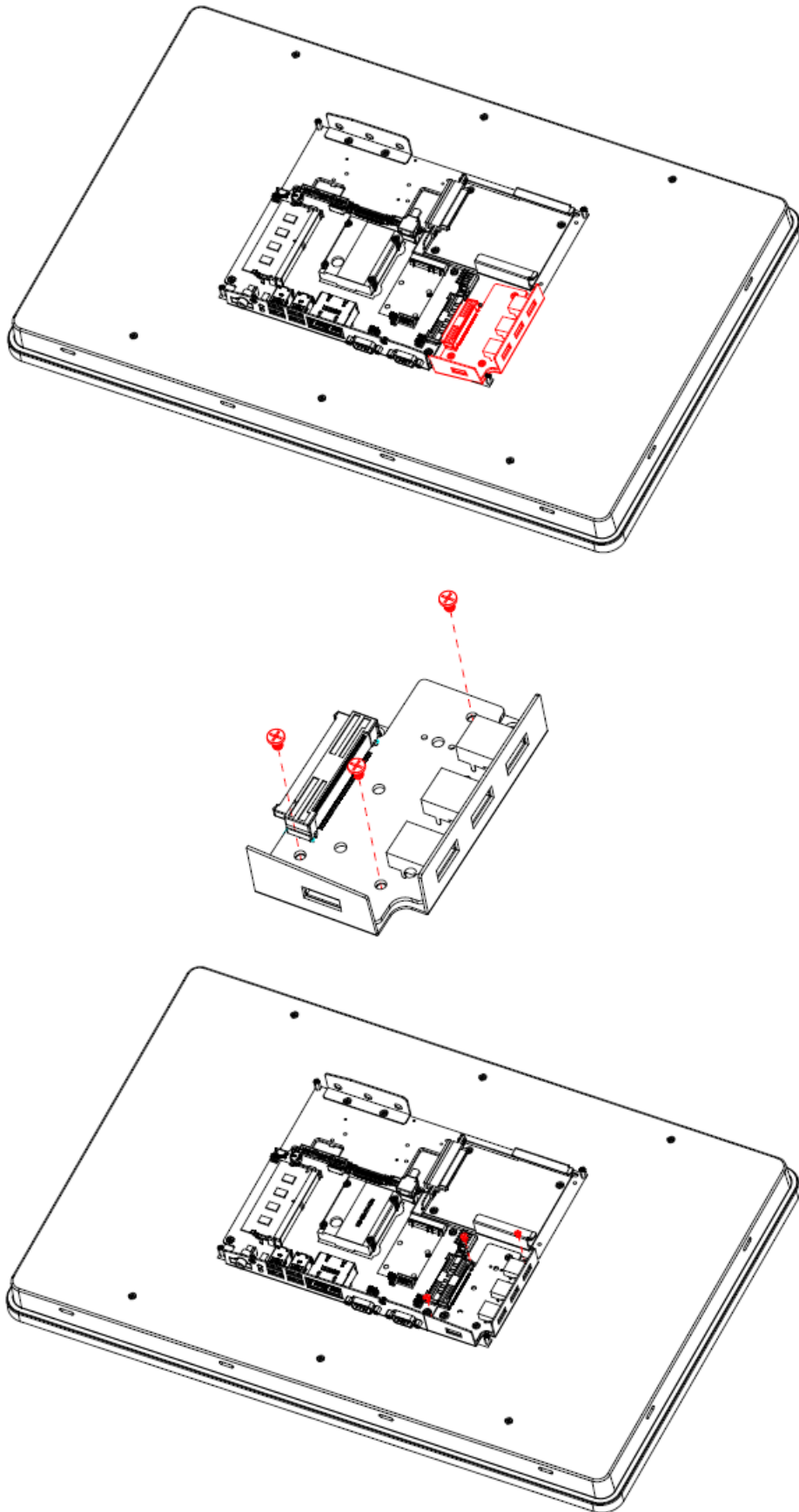

Step 3.1 Insert the ARC-BYT DB into the socket and fasten 3 screws.

Step 3.2 Re-assemble your system back through previous steps to complete the installation.

3.4 System Mounting

Warning! *More than one person should participate in mounting the panel PC to prevent accidental damage to the panel or personal injury.*



Safety Precautions

Observe the following common safety precautions before installing any electronic device:

- Use separate, non-intersecting paths to route power and networking wires. If power wiring and device wiring paths must be crossed make sure the wires are perpendicular at the intersection point.
- Keep the wires separated according to the interface. Wires that share similar electrical characteristics must be bundled together.
- Do not bundle input wiring with output wiring. Keep them separate.
- When necessary, it is strongly advised that you label wiring to all devices in the system.

The panel PC supports various mounting options, as listed below.

- Wall mounting (ACC-RITYVESA-B075R, Demonstration only)
- Arm/ Stand mounting (ACC-ARM-D41R, Demonstration only)
- Panel mounting (Mounting kit in the package)
- VESA mounting (Screws in the package)

3.4.1 Wall Mounting

To mount the panel PC onto wall, follow the instruction below (see Figure for addition reference).

1. Insert four M4 screws into the VESA holes on the panel PC and tighten them to secure the bracket to the rear panel, ensure that the thread depth of the screws on the rear panel does not exceed 4mm.

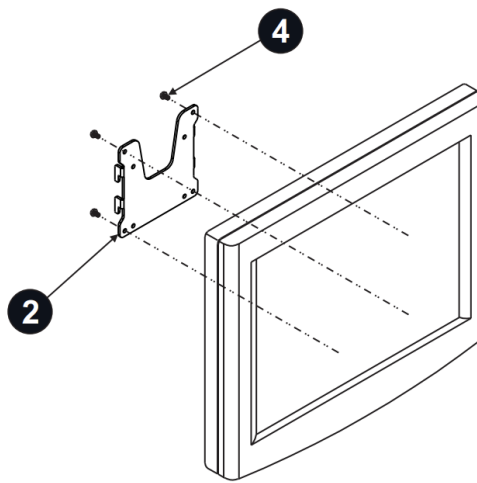

2. Select the location on the wall for the wall mount plate, secure the mount plate to the wall by inserting four M5 screws into pilot holes and tightening them.

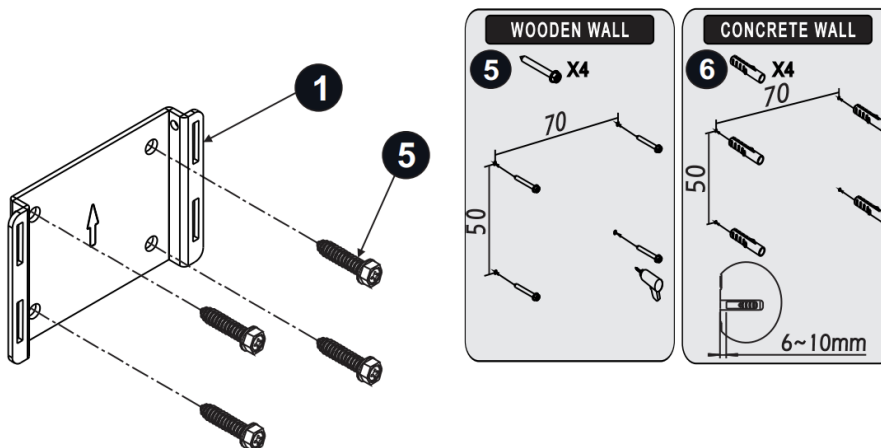

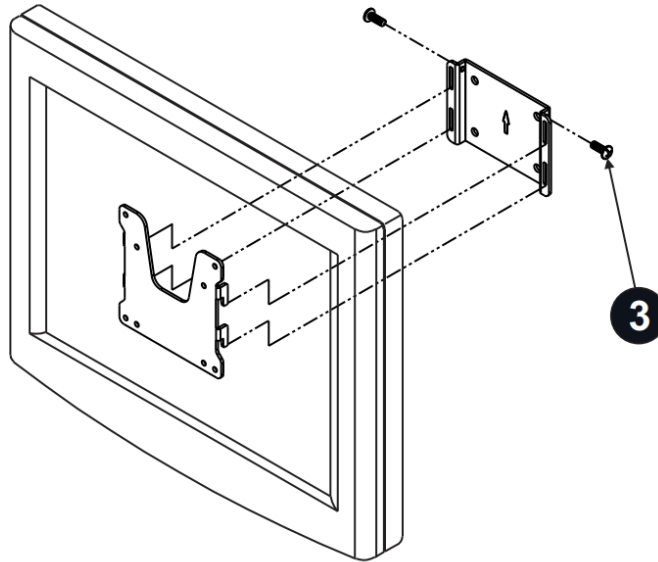

ARC-21W38

- To mount the panel PC on the wall, align the wall mount bracket attached to the panel PC with the wall mount plate on the wall and slide the panel PC downwards to hang the bracket on the mount plate. Secure the panel PC in place by tightening screws in the wall mount bracket.





MAIN PARTS

| ITEM | 1 | 2 | 3 |
|-------|---|---|--|
| PARTS |  |  |  M5X15 |
| QTY | 1 | 1 | 2 |

PARTS FOR TV BRACKETS

| ITEM | 4 |
|-------|---|
| PARTS |  |
| QTY | 4 |

PARTS FOR WALL BRACKETS

| ITEM | 5 | 6 |
|-------|---|---|
| PARTS |  |  |
| QTY | 4 | 4 |

3.4.2 Arm/ Stand Mounting

This Panel PC can be mounted on a VESA-compliant arm mount with a 100mm interface pad. To affix the panel PC to an arm mount, follow the steps below.

1. Refer to the installation instruction of mounting arm/ stand to correctly assembly the arm/ stand onto the surface as a base.
2. Align the retention screw holes on the mounting arm interface with VESA holes in the panel PC and secure the panel PC with four M4 retention screws. Ensure that the thread depth of the screws on the rear panel does not exceed 4mm.

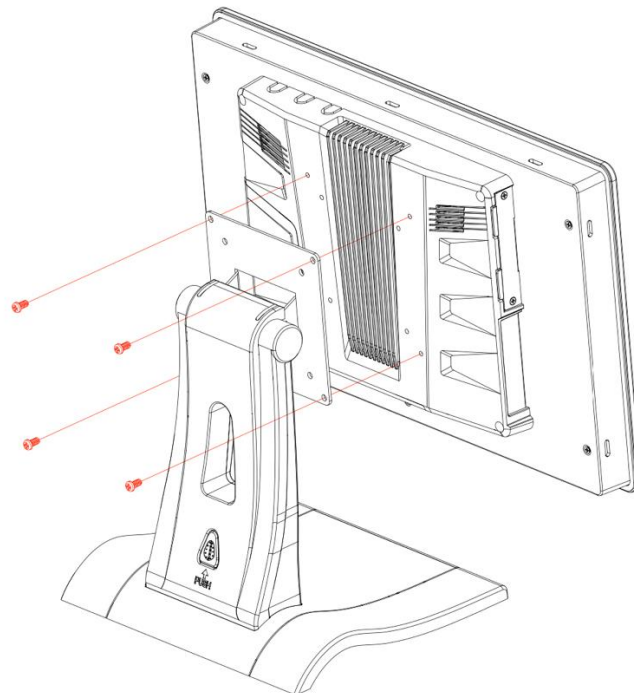

3.4.3 Panel Mounting

To mount the flat bezel panel PC into a panel, follow the steps below.

1. Prepare a panel cutout according to the panel PC dimensions. For the panel cutout dimension, please refer to “System Dimensions” section in this manual.

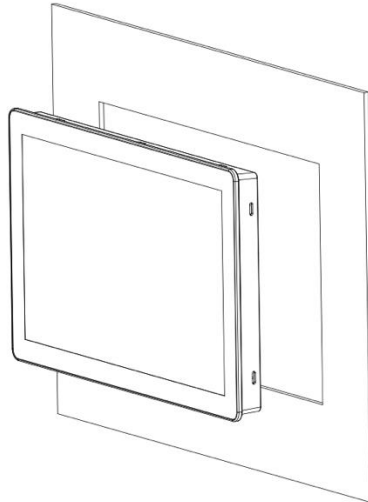

2. Install the panel PC in the cabinet and retrieve hook brackets from the accessory box.

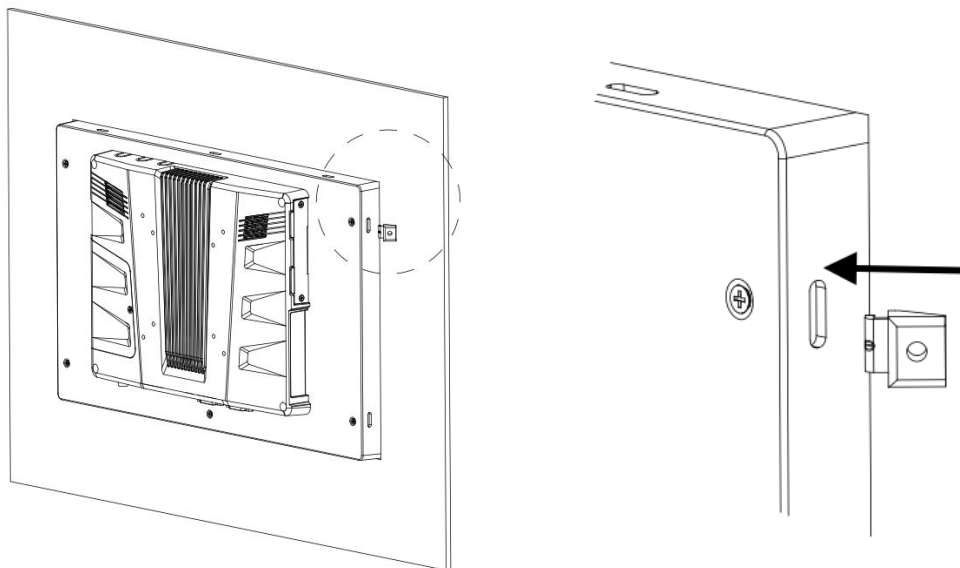

3. Insert the hook brackets into the holes following the direction of the arrows shown in below figure and hang the panel PC.

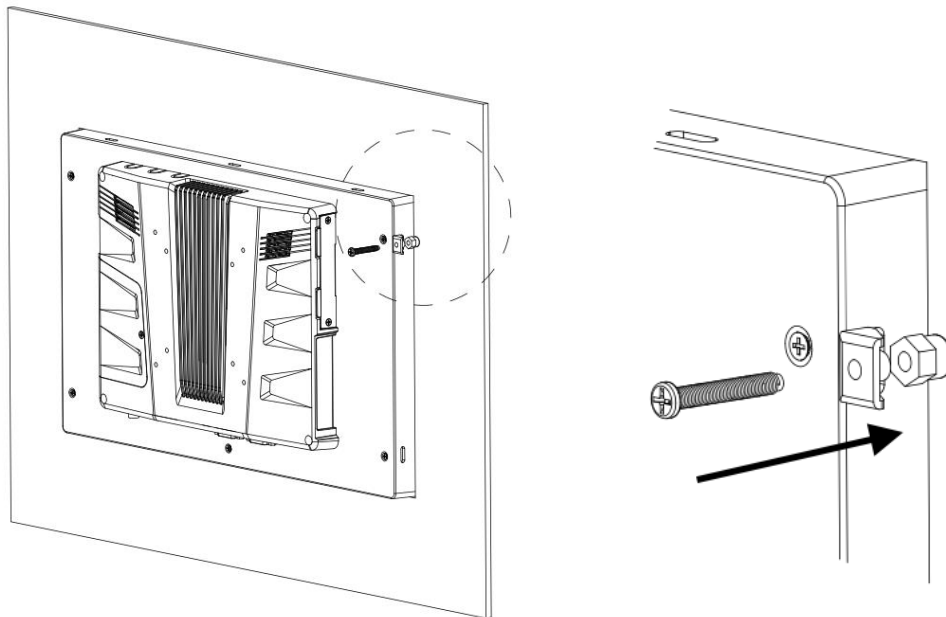

4. Tighten the screws to affix the panel PC in place, fasten all the hook bracket to ensure panel PC well fix at cabinet.

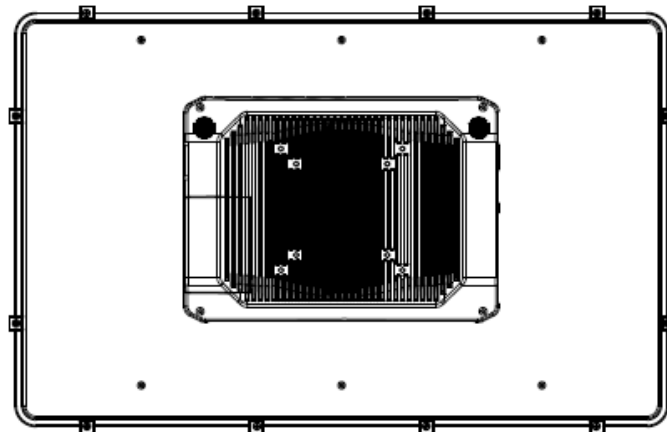

ARC-21W38

3.4.4 VESA Mounting

The following picture indicates VESA mounting hole pattern (75x75 / 100x100 mm) on this Panel PC. VESA mount is a widely used mounting solution suitable for all kinds of industrial applications.

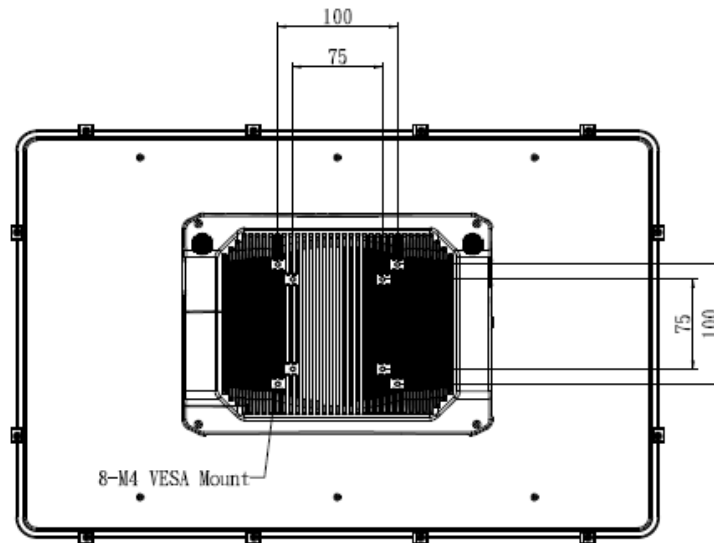

4. Drivers Installation

All the drivers are available on Avalue Downloads Area (<https://www.avaluetech.com/en/support/download>). Type the model name and press Enter to find all the relevant software, utilities, and documentation.

Note:

The panel PC with projected capacitive type touchscreen and Windows 7 (or later) OS does not require touch driver installation. This is because there is a HID touch digitizer built-in driver in Windows 7 or later.

Chipset ¹ Audio ¹ Graphics ¹ LAN ¹ Other ¹

Chipset

Total 1 Files

| No. | Release Date | Title | Description | Download |
|-----|--------------|------------------------------------|------------------|---|
| 01 | 2023-09-20 | Intel Chipset Driver for Win10 x64 | Windows 10 64bit |  |

Audio

Total 1 Files

| No. | Release Date | Title | Description | Download |
|-----|--------------|------------------------------------|------------------|---|
| 01 | 2023-09-20 | Realtek Audio Driver for Win10 x64 | Windows 10 64bit |  |



Note: Installation procedures and screen shots in this section are for your reference and may not be exactly the same as shown on your screen.

4.1 Install Chipset Driver

All drivers can be found on the Avalue Official Website:

www.avalue.com.tw.



Note: The installation procedures and screen shots in this section are based on Windows 11 operation system. If the warning message appears while the installation process, click Continue to go on.



Step 3. Click Install.

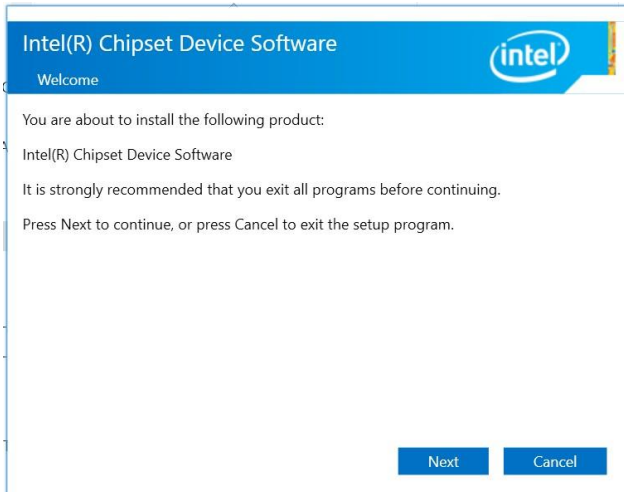

Step1. Click Next.

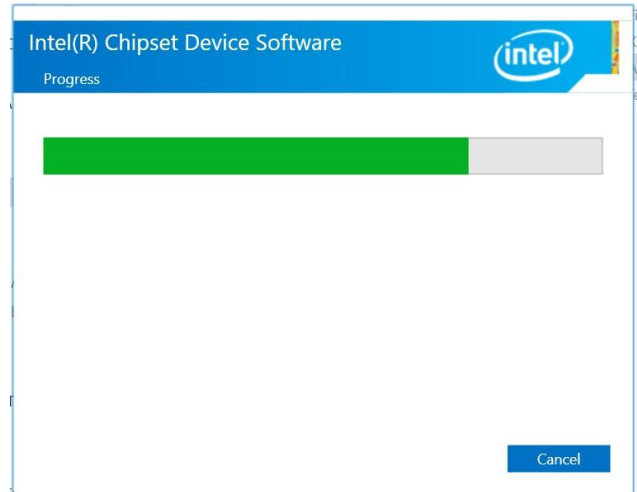

Step 4. Installing.

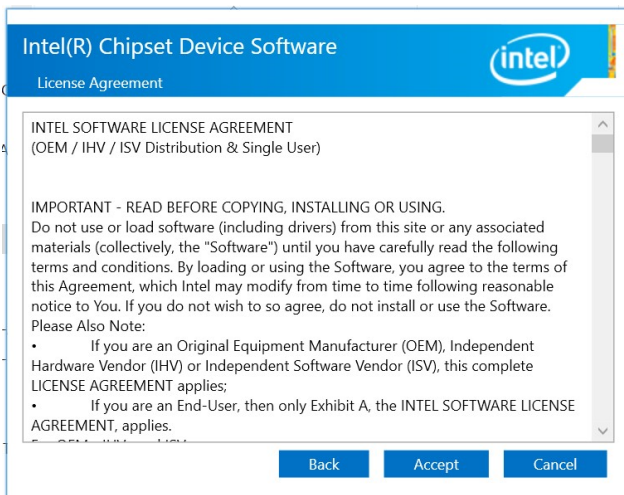

Step 2. Click Accept.



Step 5. Click Finish to complete setup.

4.2 Install VGA Driver

All drivers can be found on the Avalue Official Website:

www.avalue.com.tw.



Note: The installation procedures and screen shots in this section are based on Windows 11 operation system. If the warning message appears while the installation process, click Continue to go on.



Step 3. Click Start.



Step 1. Click Begin installation.

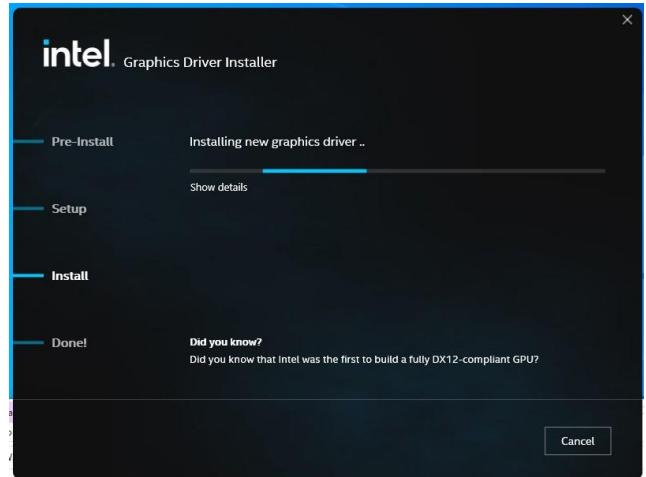

Step 4. Installing.

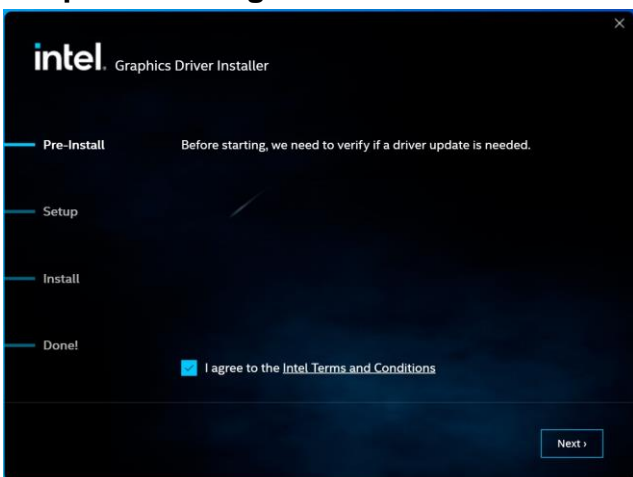

Step 2.

Click **Next** to accept license agreement.

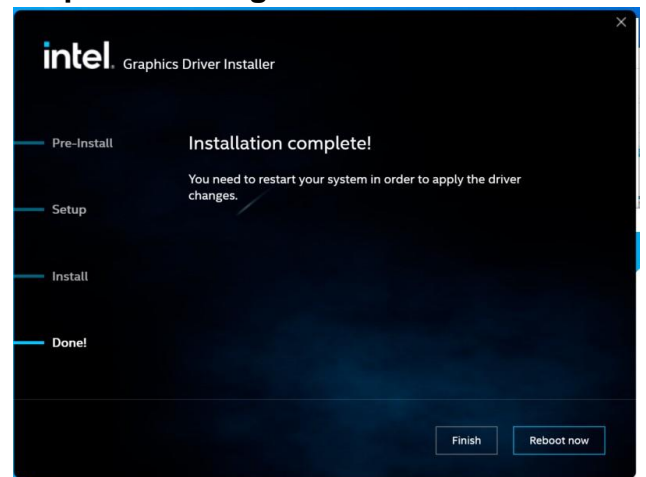

Step 5. Click Finish to complete setup.

4.3 Install ME Driver

All drivers can be found on the Avalue Official Website:
www.avalue.com.tw.



Note: The installation procedures and screen shots in this section are based on Windows 11 operation system. If the warning message appears while the installation process, click Continue to go on.

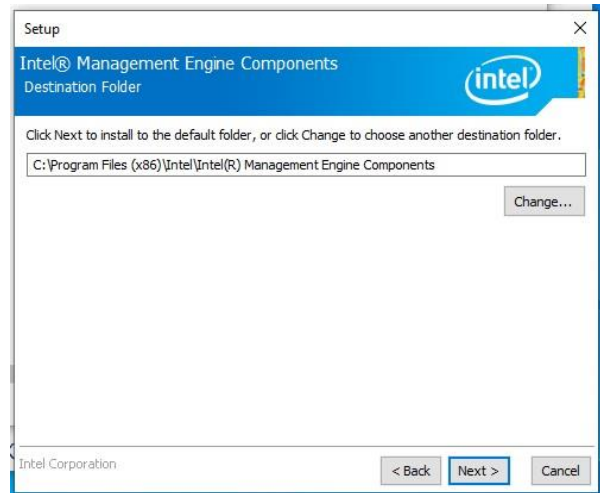

Step 3. Click Next.

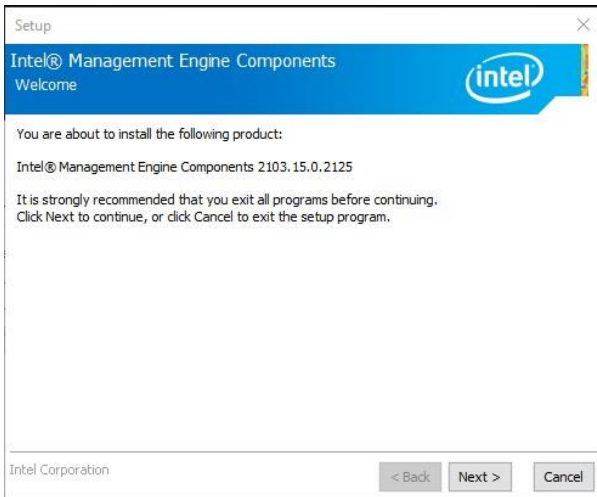

Step 1. Click Next to continue setup.

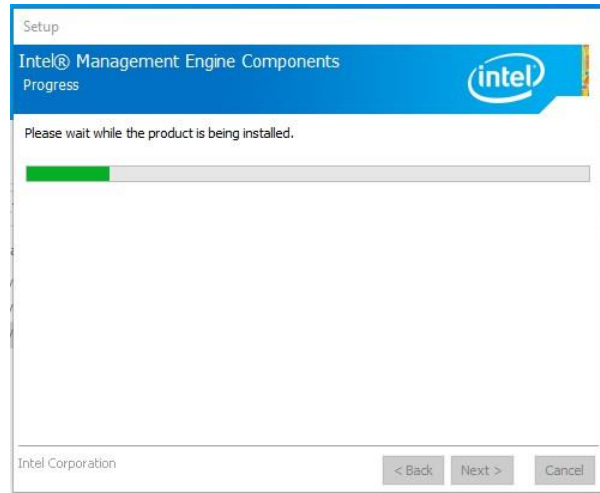

Step 4. Installing.

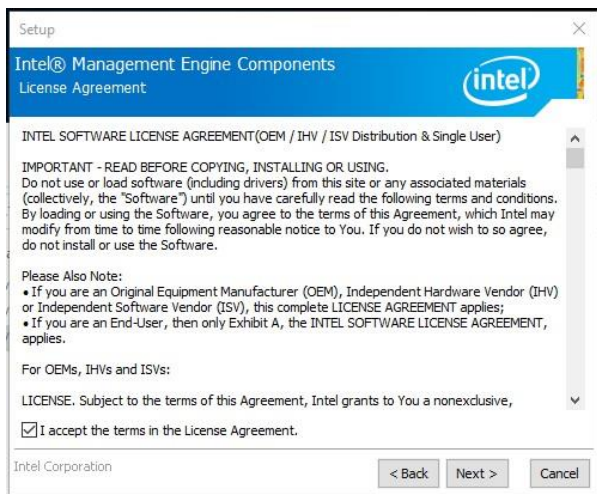

Step 2. Click Next.

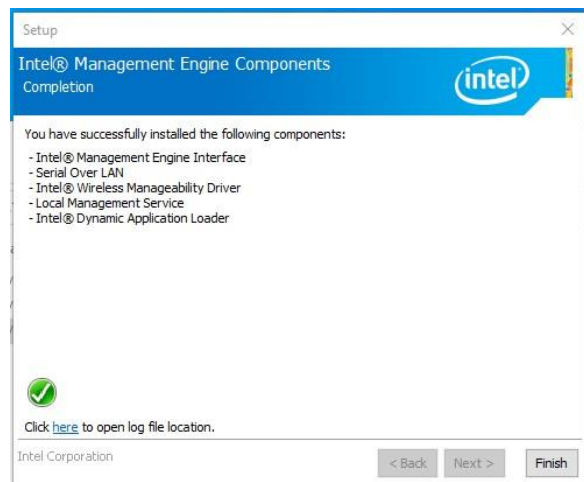

Step 5. Click Finish to complete setup.

4.4 Install USB Driver

All drivers can be found on the Avalue Official Website:
www.avalue.com.tw.



Note: The installation procedures and screen shots in this section are based on Windows 11 operation system. If the warning message appears while the installation process, click Continue to go on.

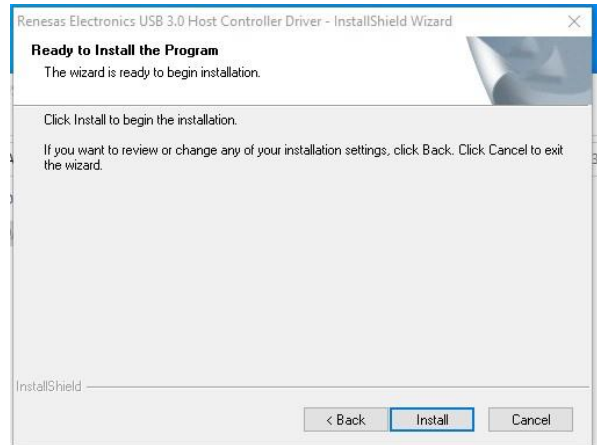

Step 3. Click Install.

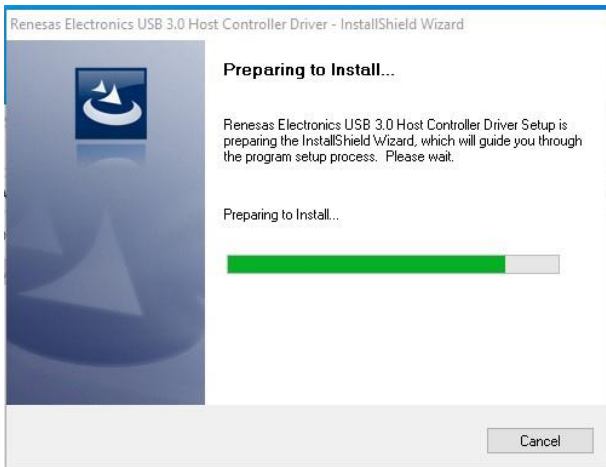

Step 1. Install USB Driver.

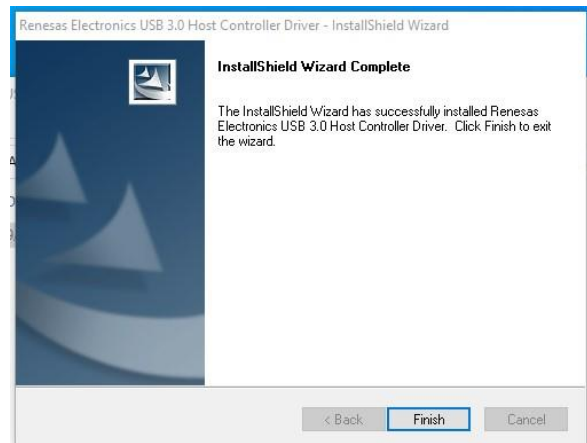

Step 4. Click Finish to complete setup.

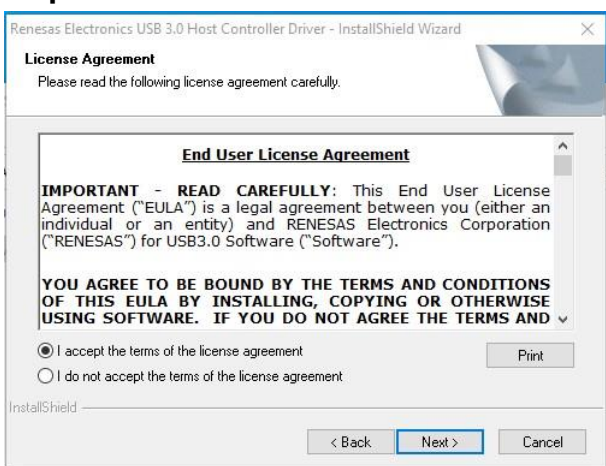

Step 2. Click Next.

4.5 Install Audio Driver (For Realtek ALC888S)

All drivers can be found on the Avalue Official Website:
www.avalue.com.tw.



Note: The installation procedures and screen shots in this section are based on Windows 11 operation system.

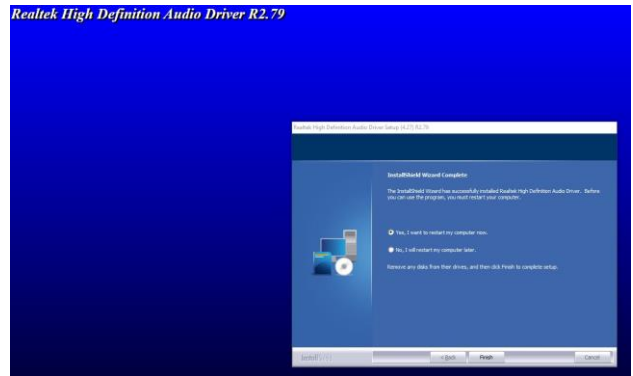

Step 3. Click **Finish** to complete setup.

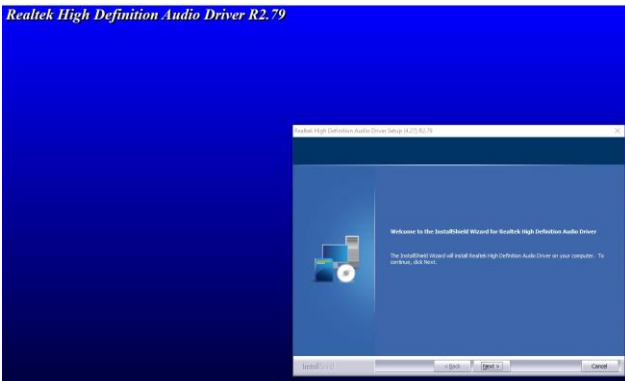

Step 1. Click **Next**.

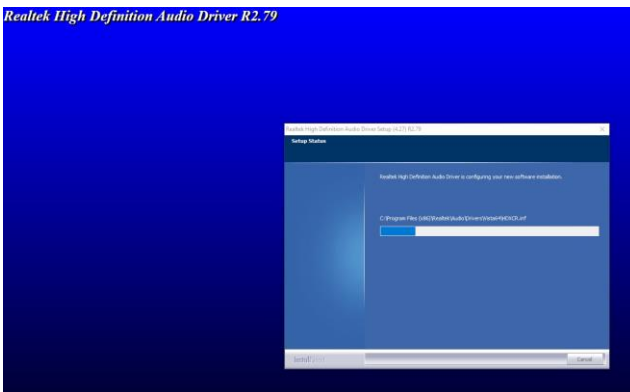

Step 2. Installing.

4.6 Install LAN Driver

All drivers can be found on the Avalue Official Website:
www.avalue.com.tw.



Note: The installation procedures and screen shots in this section are based on Windows 11 operation system. If the warning message appears while the installation process, click Continue to go on.

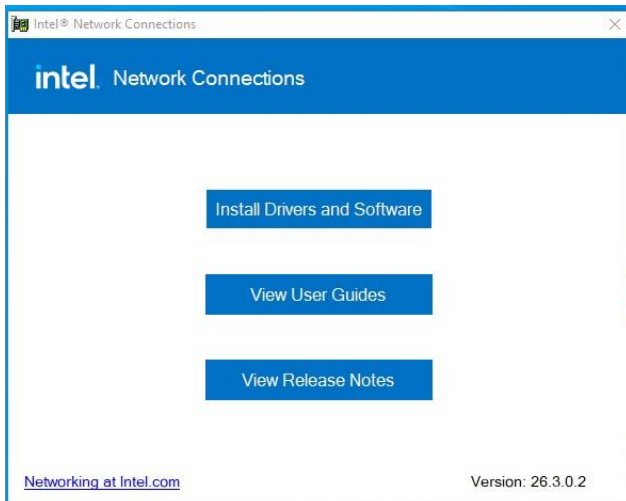

Step 1. Click Install Drivers and Software.

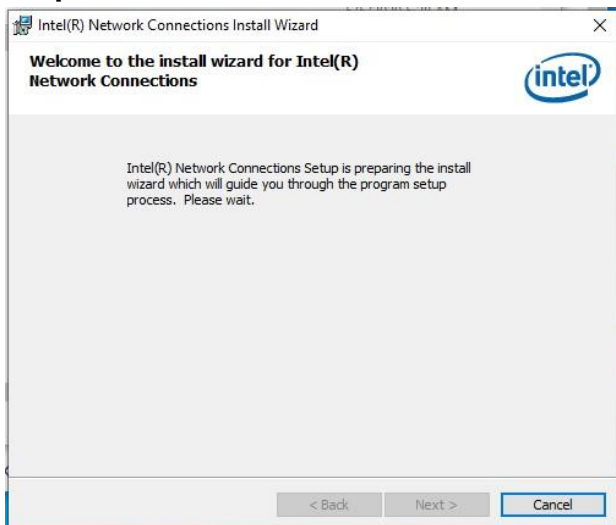

Step 2. Click Next.



Step 3. Click Next.

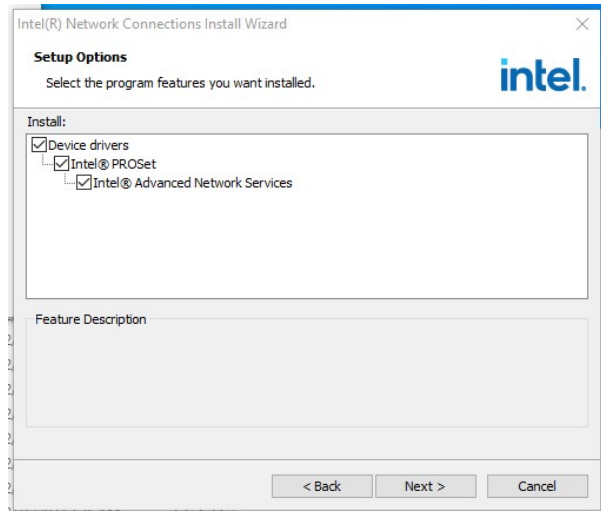

Step 4. Click Next.

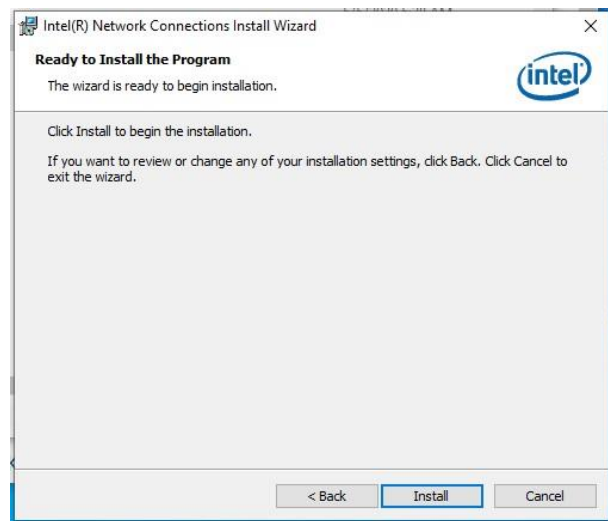

Step 5. Click Install.

ARC-21W38

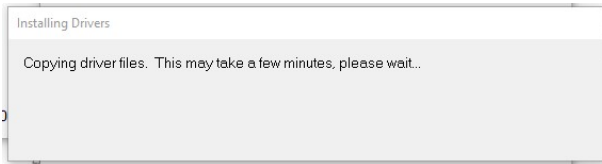

Step 6. Installing.

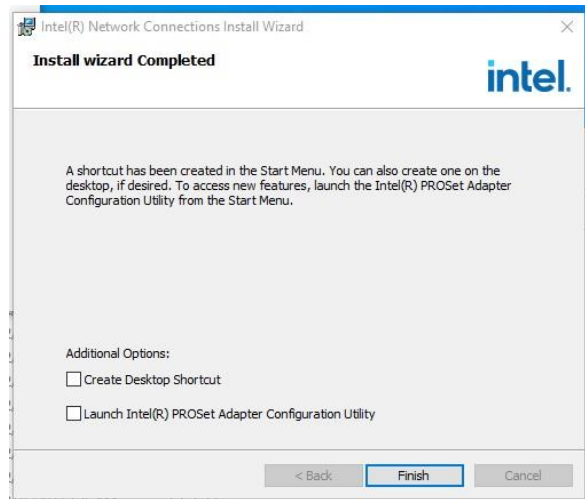

Step 7. Click **Finish** to complete setup.

5. BIOS Setup

5.1 Introduction

The BIOS setup program allows users to modify the basic system configuration. In this following chapter will describe how to access the BIOS setup program and the configuration options that may be changed.

5.2 Starting Setup

The AMI BIOS™ is immediately activated when you first power on the computer. The BIOS reads the system information contained in the NVRAM and begins the process of checking out the system and configuring it. When it finishes, the BIOS will seek an operating system on one of the disks and then launch and turn control over to the operating system.

While the BIOS is in control, the Setup program can be activated in one of two ways:

By pressing or <F2> immediately after switching the system on, or

By pressing the or <F2> key when the following message appears briefly at the left-top of the screen during the POST (Power On Self Test).

Press or <F2> to enter SETUP

If the message disappears before you respond and you still wish to enter Setup, restart the system to try again by turning it OFF then ON or pressing the "RESET" button on the system case. You may also restart by simultaneously pressing <Ctrl>, <Alt>, and <Delete> keys. If you do not press the keys at the correct time and the system does not boot, an error message will be displayed and you will again be asked to.

Press F1 to Continue, DEL to enter SETUP

5.3 Using Setup

In general, you use the arrow keys to highlight items, press <Enter> to select, use the PageUp and PageDown keys to change entries, press <F1> for help and press <Esc> to quit. The following table provides more detail about how to navigate in the Setup program using the keyboard.

| Button | Description |
|--------|----------------------------|
| ↑↓→← | Move |
| Enter | Select |
| +/- | Value |
| Esc | Exit |
| F1 | General Help |
| F2 | Previous Values |
| F3 | Optimized Defaults |
| F4 | Save & Exit Setup |
| <K> | Scroll help area upwards |
| <M> | Scroll help area downwards |

- **Navigating Through The Menu Bar**

Use the left and right arrow keys to choose the menu you want to be in.



Note: Some of the navigation keys differ from one screen to another.

- **To Display a Sub Menu**

Use the arrow keys to move the cursor to the sub menu you want. Then press <Enter>. A “>” pointer marks all sub menus.

5.4 Getting Help

Press F1 to pop up a small help window that describes the appropriate keys to use and the possible selections for the highlighted item. To exit the Help Window press <Esc> or <Enter> key.

5.5 In Case of Problems

If, after making and saving system changes with Setup, you discover that your computer no longer is able to boot, the AMI BIOS supports an override to the NVRAM settings which resets your system to its defaults.

The best advice is to only alter settings which you thoroughly understand. To this end, we strongly recommend that you avoid making any changes to the chipset defaults. These defaults have been carefully chosen by both BIOS Vendor and your systems manufacturer to provide the absolute maximum performance and reliability. Even a seemingly small change to the chipset setup has the potential for causing you to use the override.

5.6 BIOS setup

Once you enter the Aptio Setup Utility, the Main Menu will appear on the screen. The Main Menu allows you to select from several setup functions and exit choices. Use the arrow keys to select among the items and press <Enter> to accept and enter the sub-menu.

5.6.1 Main Menu

This section allows you to record some basic hardware configurations in your computer and set the system clock.

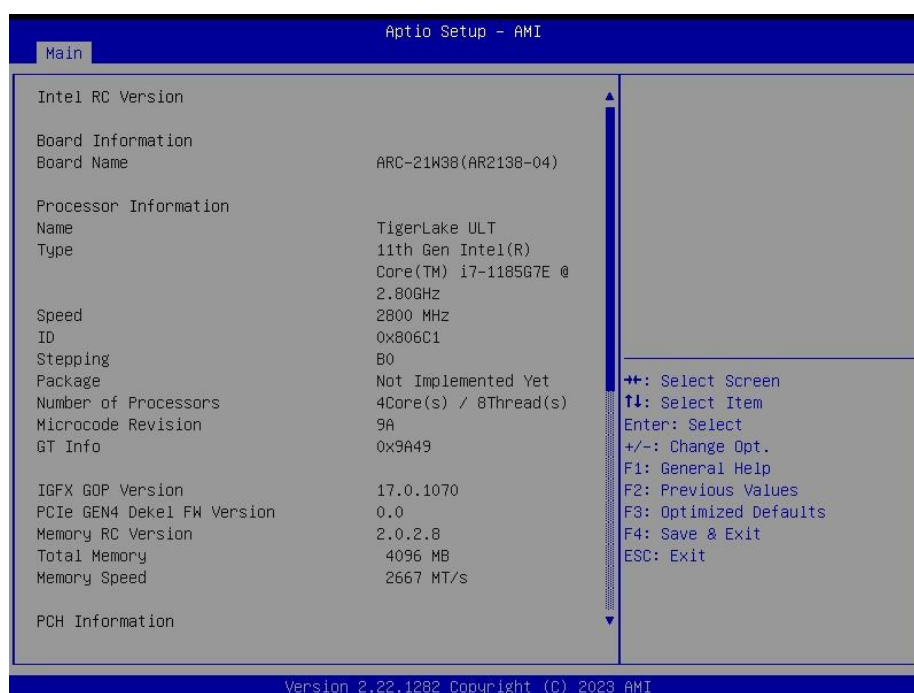
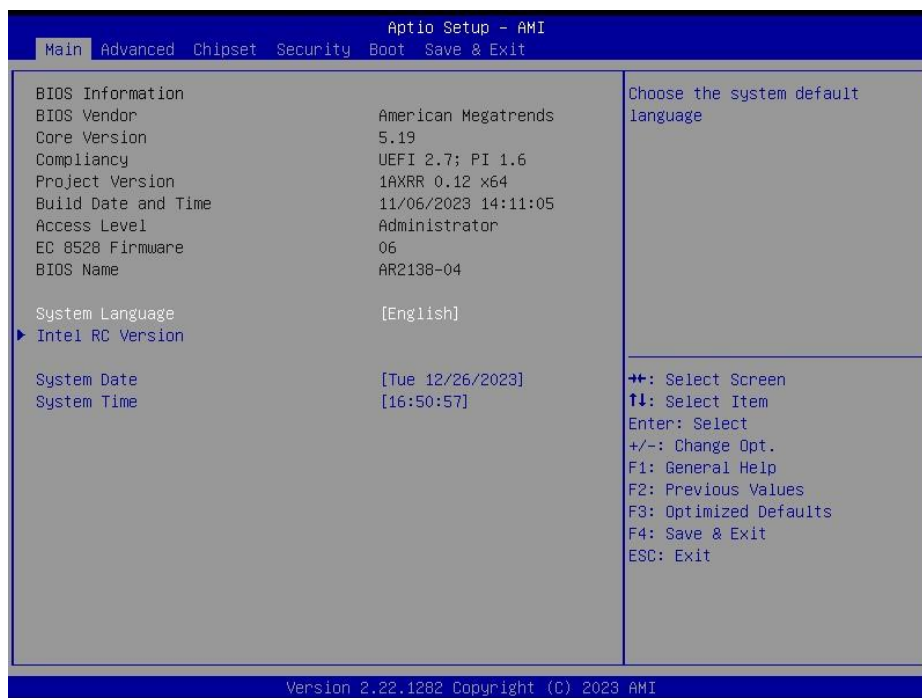

5.6.1.1 System Language

This option allows choosing the system default language.

5.6.1.2 System Date

Use the system date option to set the system date. Manually enter the month, day and year.

5.6.1.3 System Time

Use the system time option to set the system time. Manually enter the hours, minutes and seconds.



Note: The BIOS setup screens shown in this chapter are for reference purposes only, and may not exactly match what you see on your screen.

Visit the Avalue website (www.avalu.com.tw) to download the latest product and BIOS information.

5.6.2 Advanced Menu

This section allows you to configure your CPU and other system devices for basic operation through the following sub-menus.

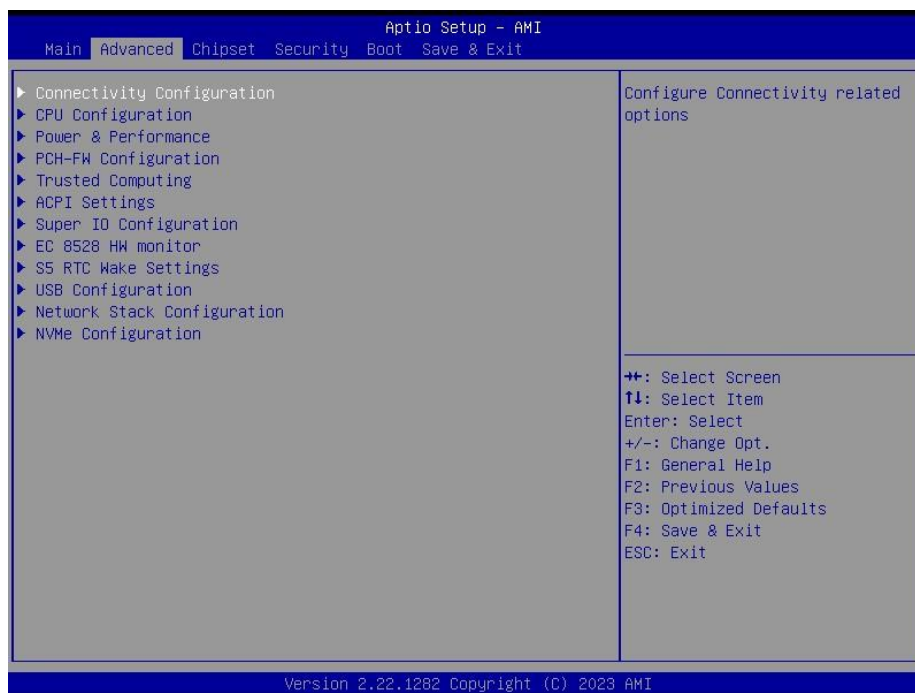

5.6.2.1 Connectivity Configuration



| Item | Options | Description |
|------------------|---|---|
| CNVi Mode | Disables Integrated Auto Detection [Default] | This option configures Connectivity. [Auto Detection] means that if Discrete solutions is discovered it will be enabled by default. Otherwise Integrated solution (CNVi) will be enabled; [Disable Integrated] disables Integrated Solution. NOTE: When CNVi is present, the GPIO pins that are used for radio. |

5.6.2.2 CPU Configuration

Use the CPU configuration menu to view detailed CPU specification and configure the CPU.

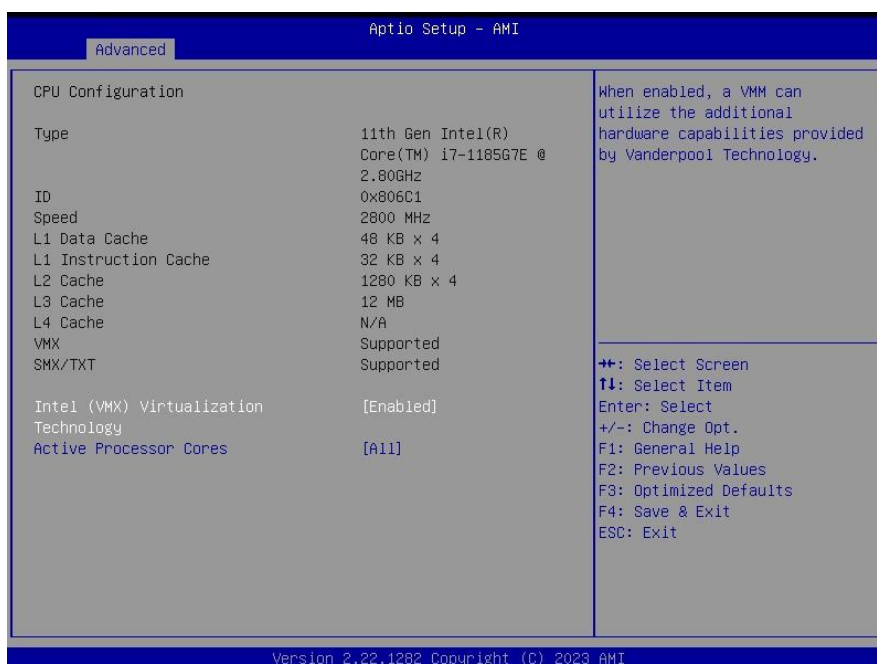

| Item | Options | Description |
|---------------------------------------|--|---|
| Intel (VMX) Virtualization Technology | Disabled Enabled[Default] | When enabled, a VMM can utilize the additional hardware capabilities provided by Vanderpool Technology. |
| Active Processor Cores | All[Default] 1 2 3 4 5 6 7 8 | Number of cores to enable in each processor package. |

5.6.2.3 Power & Performance



5.6.2.3.1 CPU – Power Management Control

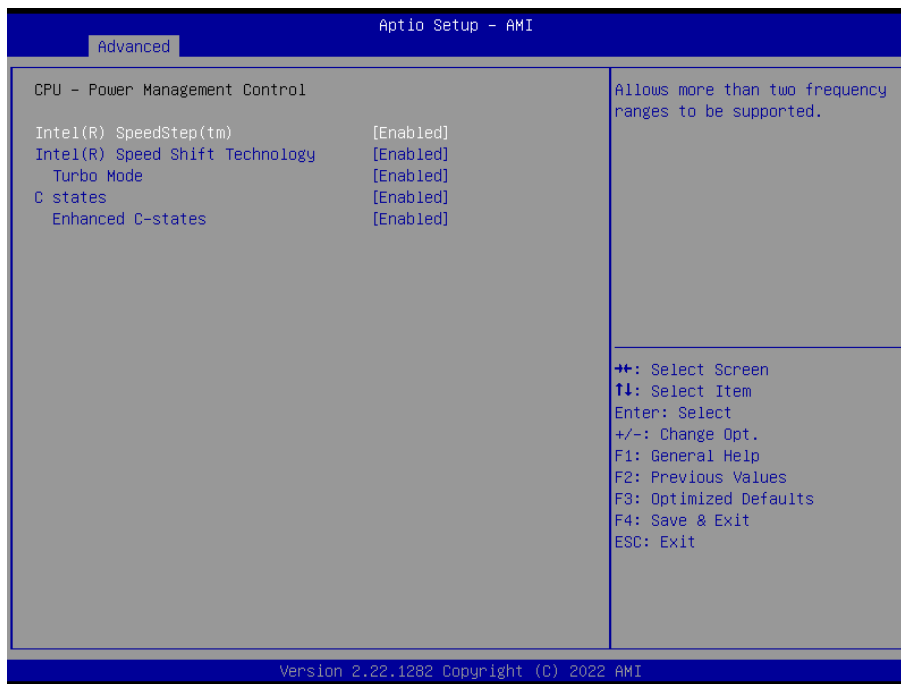

| Item | Option | Description |
|--------------------------------------|-------------------------------|---|
| Intel® SpeedStep™ | Enabled[Default], Disabled | Allows more than two frequency ranges to be supported. |
| Intel® Speed Shift Technology | Enabled[Default], Disabled | Enable/Disable Intel® Speed Shift Technology support. Enabling will expose the CPPC v2 interface to allow for hardware controlled P-states. |
| Turbo Mode | Enabled[Default], Disabled | Enable/Disable processor Turbo Mode (requires Intel Speed Step or Intel Speed Shift to be available and enabled). |
| C States | Enabled[Default], Disabled | Enable/Disable CPU Power Management. Allows CPU to go to C states when it's not 100% utilized. |
| Enhanced C-states | Enabled[Default], Disabled | Enable/Disable C1E. When enabled, CPU will switch to minimum speed when all cores enter C-State. |

5.6.2.4 PCH-FW Configuration

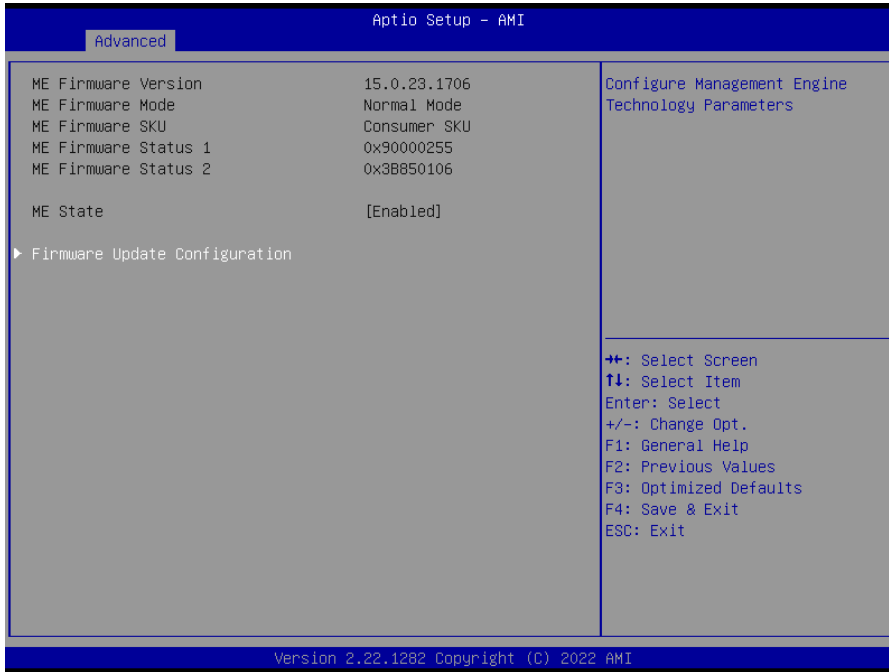

5.6.2.4.1 Firmware Update Configuration

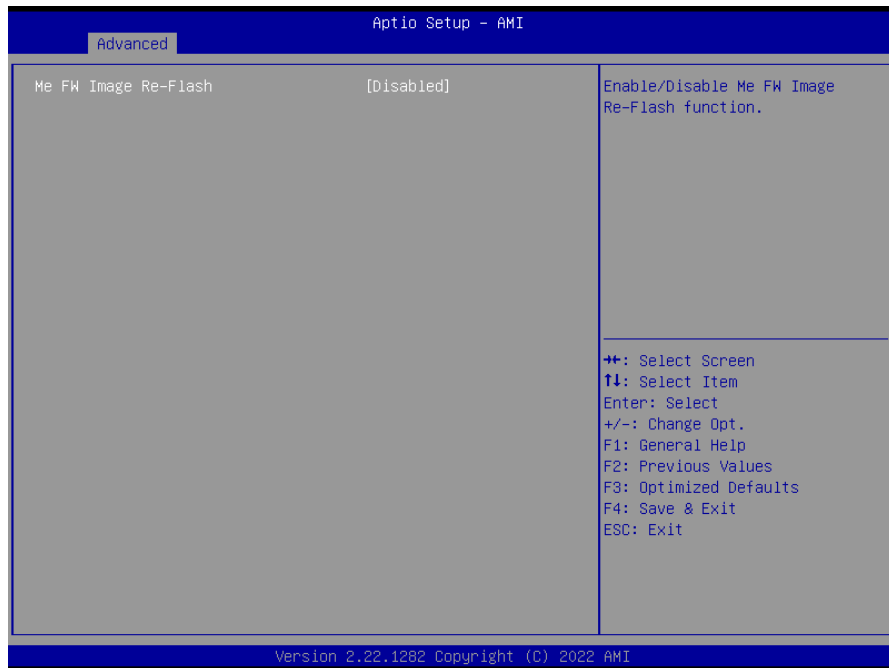

| Item | Option | Description |
|----------------------|-------------------------------|---|
| ME FW Image Re-Flash | Disabled[Default], Enabled | Enable/Disable Me FW Image Re-Flash function. |

5.6.2.5 Trusted Computing



| Item | Options | Description |
|--------------------------------|--------------------------------------|---|
| Security Device Support | Disable, Enable[Default] | Enables or Disables BIOS support for security device. O.S. will not show Security Device. TCG EFI protocol and INT1A interface will not be available. |

5.6.2.6 APCI Settings



| Item | Options | Description |
|---------------------------|--|---|
| Enable Hibernation | Disabled Enabled[Default], | Enables or Disables System ability to Hibernate (OS/S4 Sleep State). This option may not be effective with some OS. |

ARC-21W38

| | | |
|-------------------------|--|---|
| ACPI Sleep State | Suspend Disabled, S3 (Suspend to RAM)[Default] | Select the highest ACPI sleep state the system will enter when the SUSPEND button is pressed. |
|-------------------------|--|---|

5.6.2.7 Super IO Configuration

You can use this item to set up or change the Super IO configuration for serial ports. Please refer to 5.6.2.7.1 ~ 5.6.2.7.5 for more information.

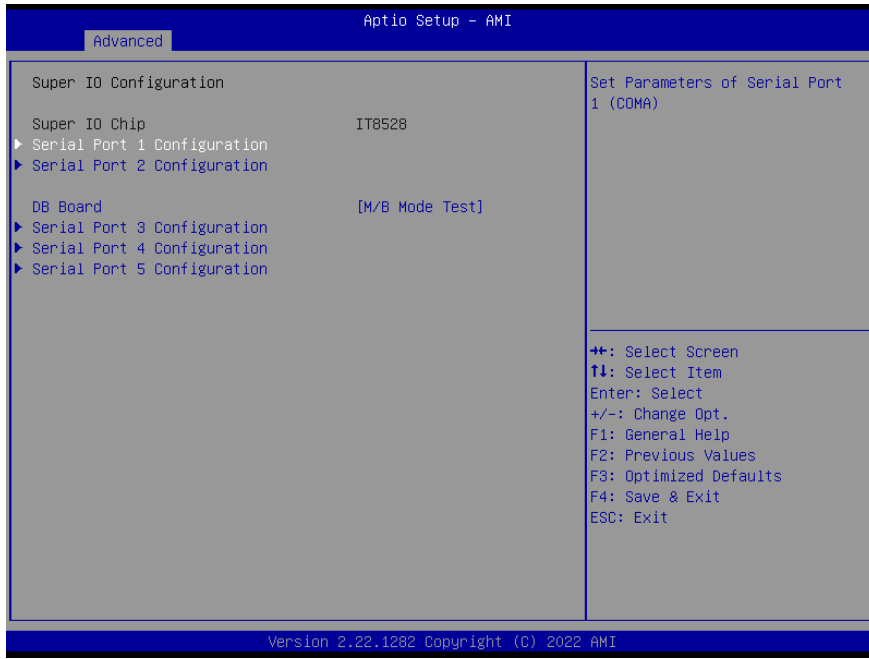

| Item | Options | Description |
|------------------------------------|--|---|
| Serial Port 1 Configuration | | Set Parameters of Serial Port 1 (COMA). |
| Serial Port 2 Configuration | | Set Parameters of Serial Port 2 (COMB). |
| DB Board | DB-A/C/E/J DB-B DB-F 1COM DB-D/H/K 2COM DB-G 3COM M/B Mode Test[Default] | DB Board A-K: DB-A/B/C/E/J w/o UART DB-G w/t 3UART DB-D/H/K w/t 2UART DB-F w/t 1UART. |
| Serial Port 3 Configuration | | Set Parameters of Serial Port 3 (COMC). |
| Serial Port 4 Configuration | | Set Parameters of Serial Port 4 (COMD). |
| Serial Port 5 Configuration | | Set Parameters of Serial Port 5 (COME). |

5.6.2.7.1 Serial Port 1 Configuration

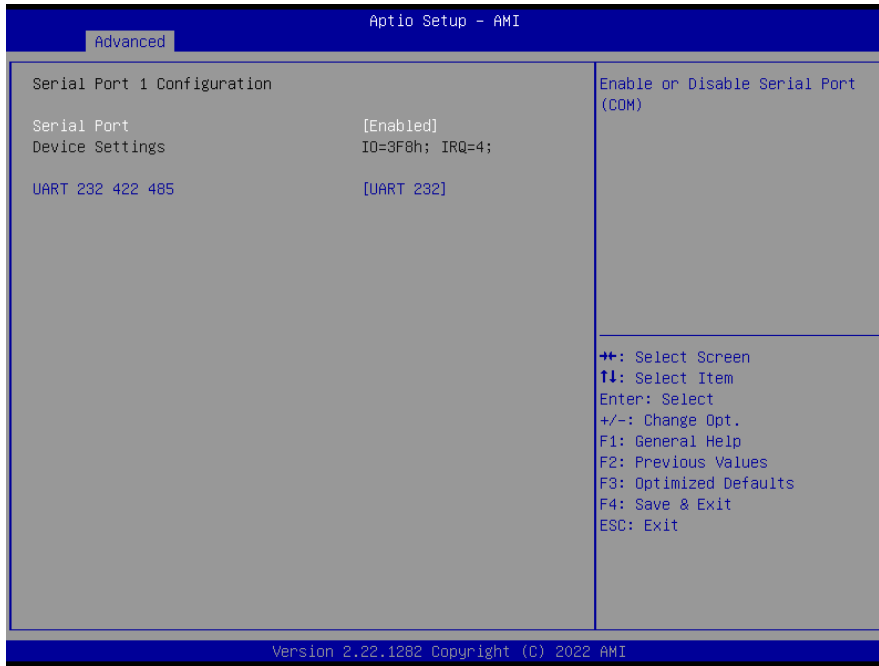

| Item | Option | Description |
|------------------|---|--|
| Serial Port | Enabled[Default], Disabled | Enable or Disable Serial Port (COM). |
| UART 232 422 485 | UART 232[Default] UART 422 UART 485 | Change the Serial Port as RS232/422/485. |

5.6.2.7.2 Serial Port 2 Configuration

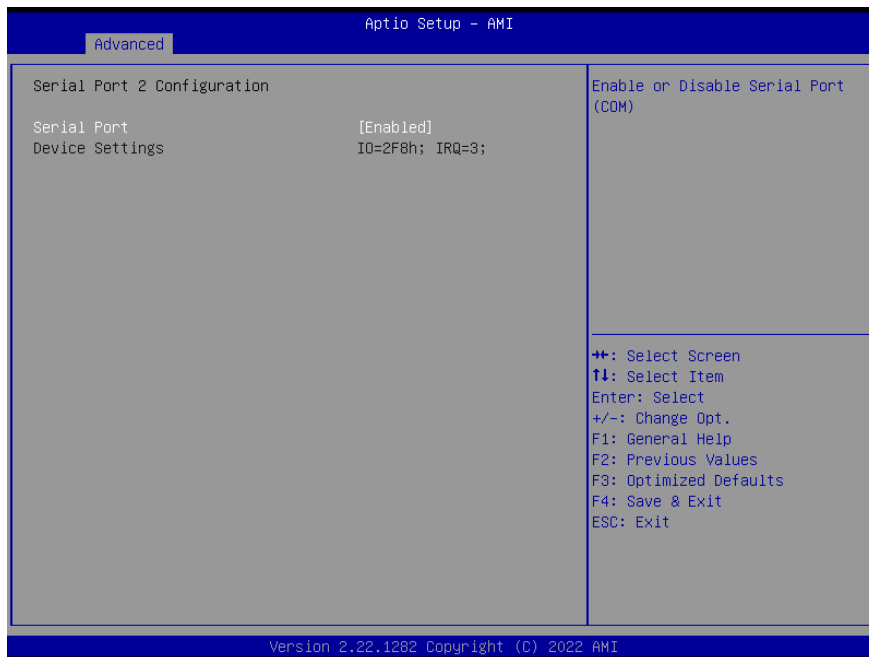

| Item | Option | Description |
|-------------|-------------------------------|--------------------------------------|
| Serial Port | Enabled[Default], Disabled | Enable or Disable Serial Port (COM). |

5.6.2.7.3 Serial Port 3 Configuration

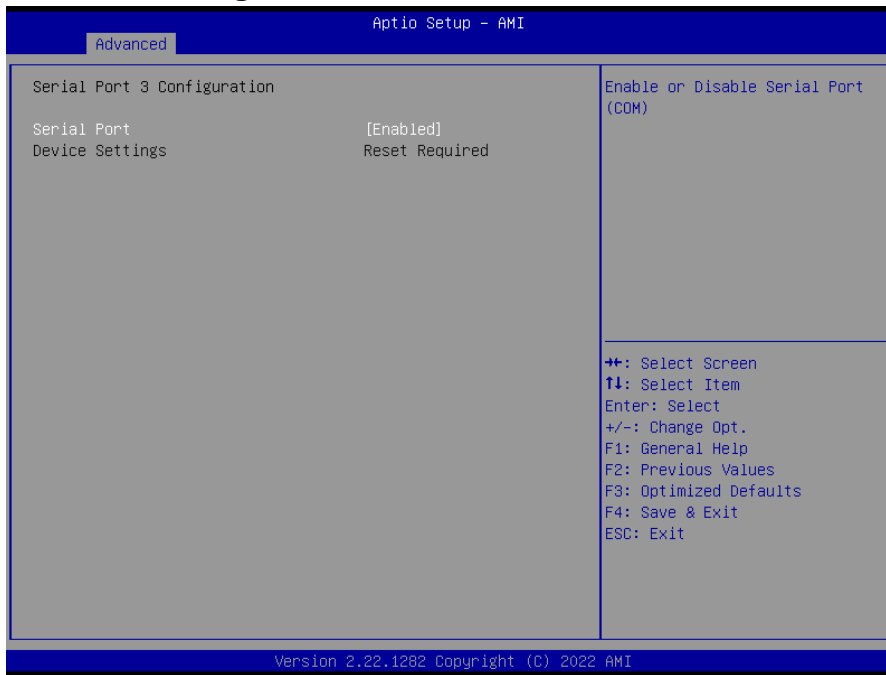

| Item | Option | Description |
|-------------|-------------------------------|--------------------------------------|
| Serial Port | Enabled[Default], Disabled | Enable or Disable Serial Port (COM). |

5.6.2.7.4 Serial Port 4 Configuration

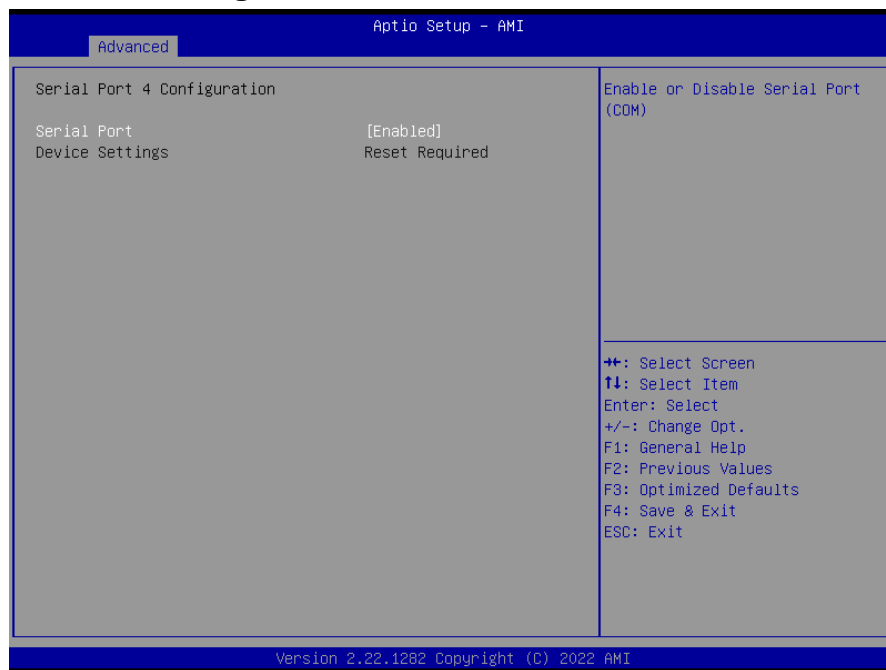

| Item | Option | Description |
|-------------|-------------------------------|--------------------------------------|
| Serial Port | Enabled[Default], Disabled | Enable or Disable Serial Port (COM). |

5.6.2.7.5 Serial Port 5 Configuration



| Item | Option | Description |
|-------------|-------------------------------|--------------------------------------|
| Serial Port | Enabled[Default], Disabled | Enable or Disable Serial Port (COM). |

5.6.2.8 HW Monitor

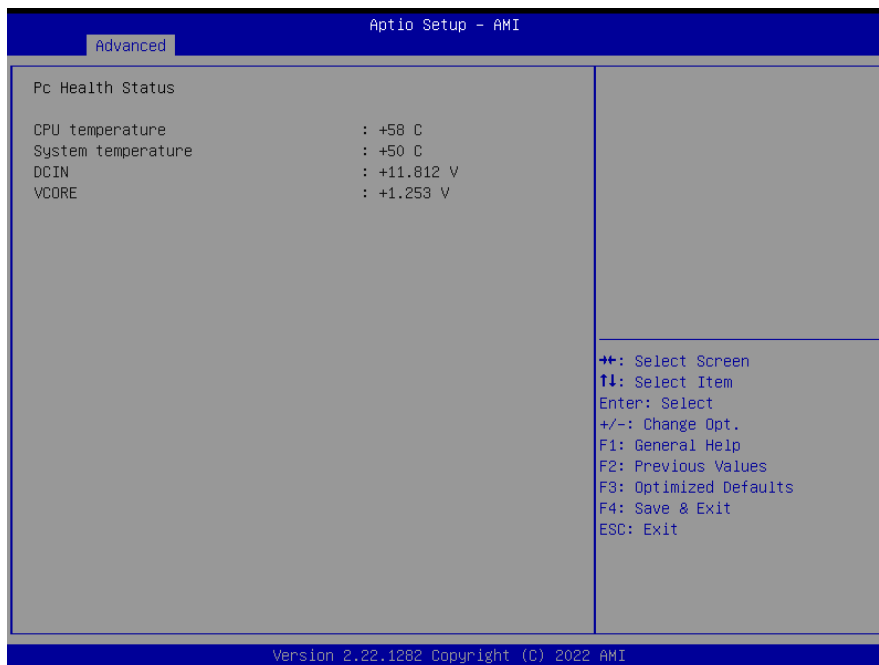

5.6.2.9 S5 RTC Wake Settings



| Item | Options | Description |
|---------------------|--|--|
| Wake system from S5 | Disabled[Default], Fixed Time Dynamic Time | Enable or disable System wake on alarm event. Select Fixed Time, system will wake on the hr::min::sec specified. Select Dynamic Time, System will wake on the current time + Increase minute(s). |

5.6.2.10 USB Configuration

The USB Configuration menu helps read USB information and configures USB settings.

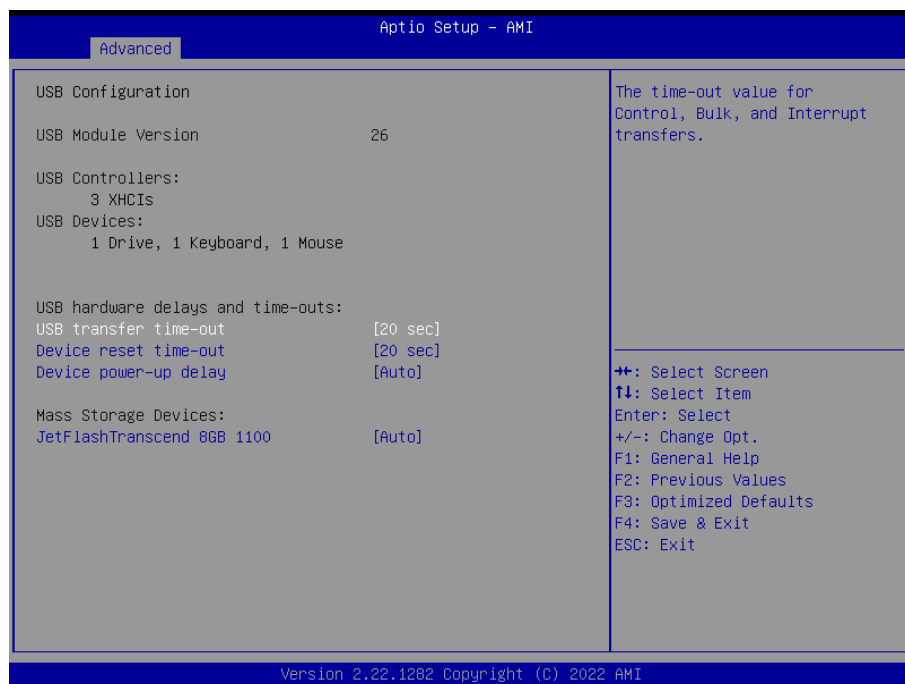

| Item | Options | Description |
|------------------------------|--|--|
| USB transfer time-out | 1 sec 5 sec 10 sec 20 sec[Default] | The time-out value for Control, Bulk, and Interrupt transfers. |
| Device reset time-out | 10 sec 20 sec[Default] 30 sec 40 sec | USB mass storage device Start Unit command time-out. |
| Device power-up delay | Auto[Default] Manual | Maximum time the device will take before it properly reports itself to the Host Controller. 'Auto' uses default value: for a Root port it is 100ms, for a Hub port the delay is taken from Hub descriptor. |
| Mass Storage Devices | Auto[Default] Floppy Forced FDD Hard Disk CD-ROM | Mass storage device emulation type. 'AUTO' enumerates devices according to their media format. Optical drives are emulated as 'CDROM', drives with no media will be emulated according to a drive type. |

5.6.2.11 Network Stack Configuration



| Item | Options | Description |
|----------------------|------------------------------|------------------------------------|
| Network Stack | Enabled Disabled[Default] | Enable/Disable UEFI Network Stack. |

5.6.2.12 NVMe Configuration

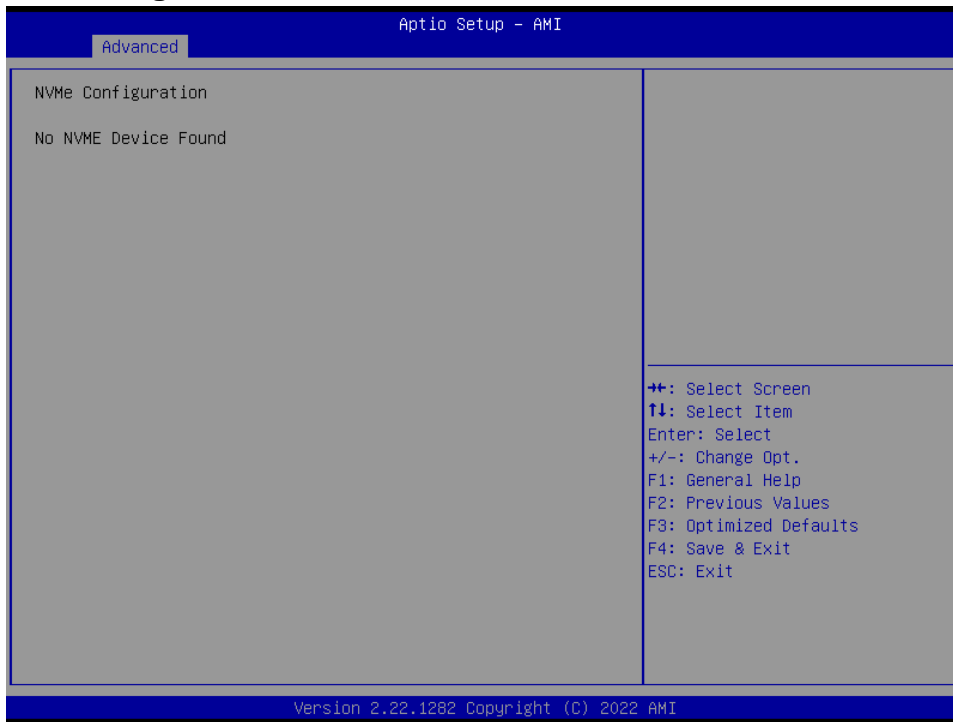

5.6.3 Chipset

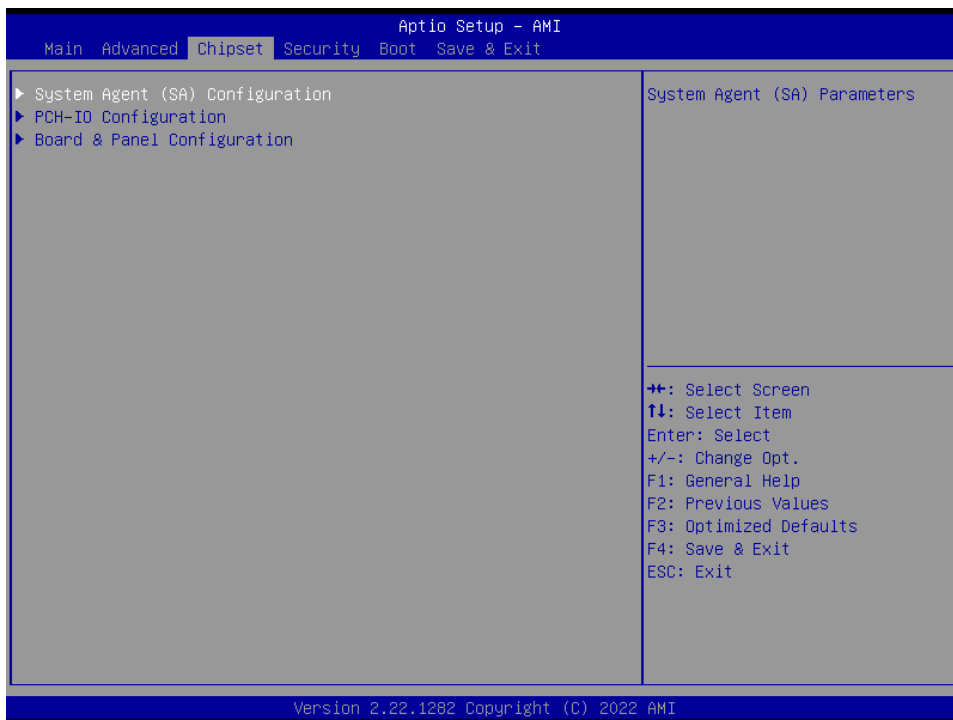

5.6.3.1 System Agent (SA) Configuration

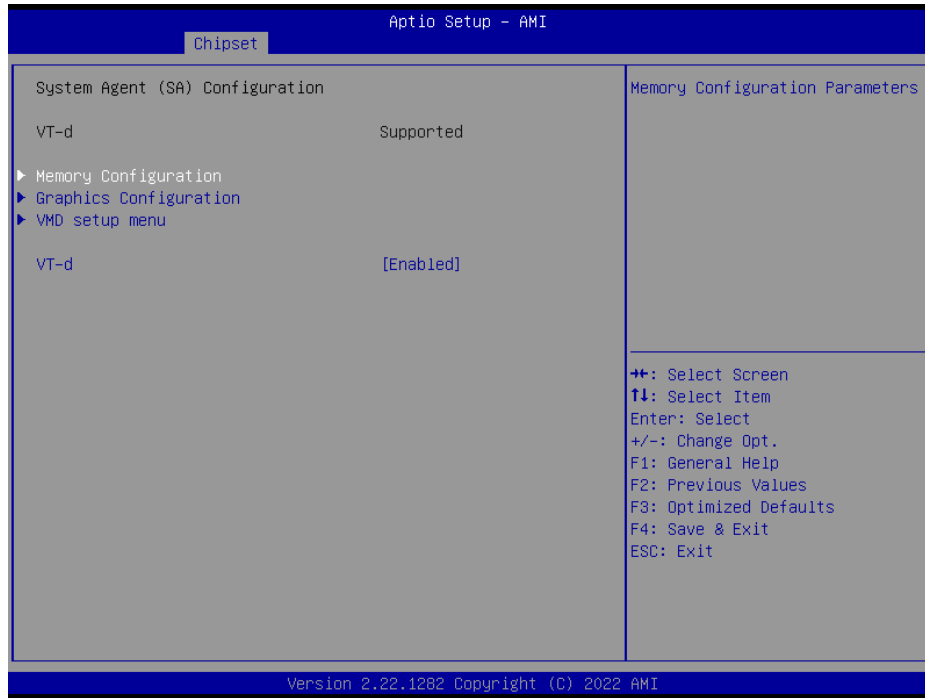

| Item | Option | Description |
|------|------------------------------|------------------|
| VT-d | Enabled[Default] Disabled | VT-d capability. |

5.6.3.1.1 Memory Configuration

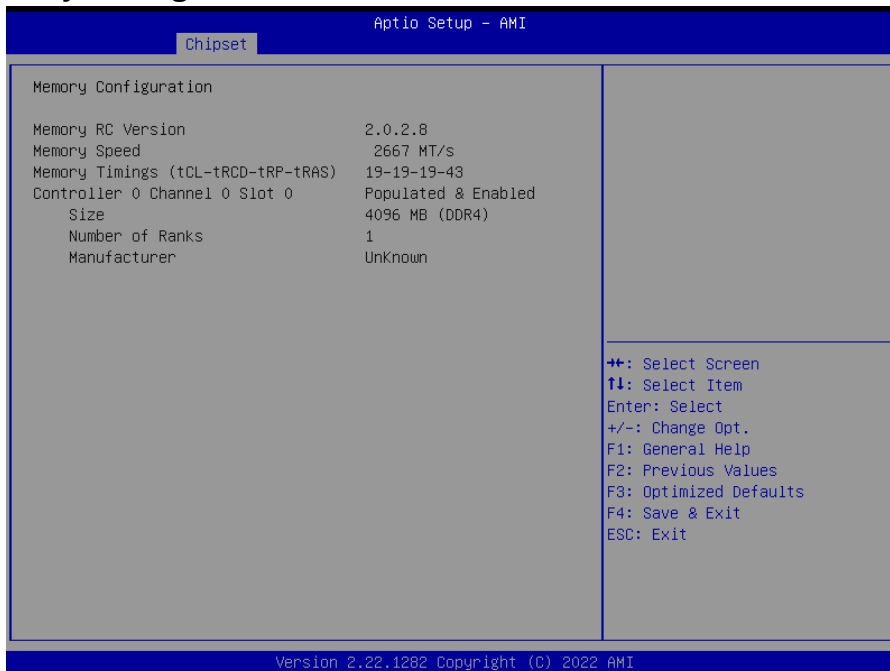

5.6.3.1.2 Graphics Configuration



| Item | Option | Description |
|-----------------|-----------------------|---|
| Primary Display | Auto[Default] IGFX | Select which of IGFX/PEG/PCI Graphics device should be Primary Display Or select HG for Hybrid Gfx. |

5.6.3.1.3 VMD Configuration

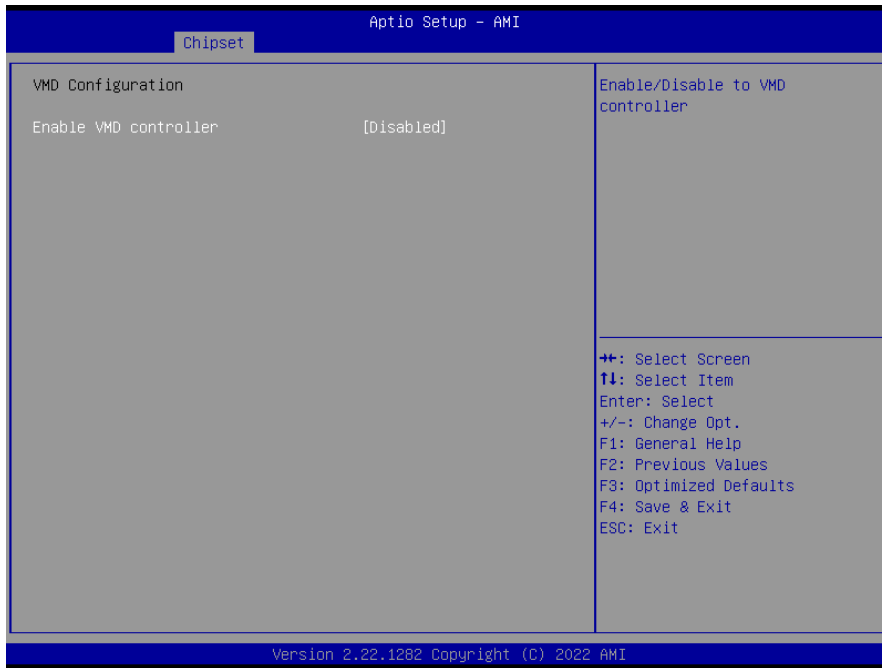

| Item | Option | Description |
|-----------------------|------------------------------|-----------------------------------|
| Enable VMD controller | Enabled Disabled[Default] | Enable/Disable to VMD controller. |

5.6.3.2 PCH-IO Configuration

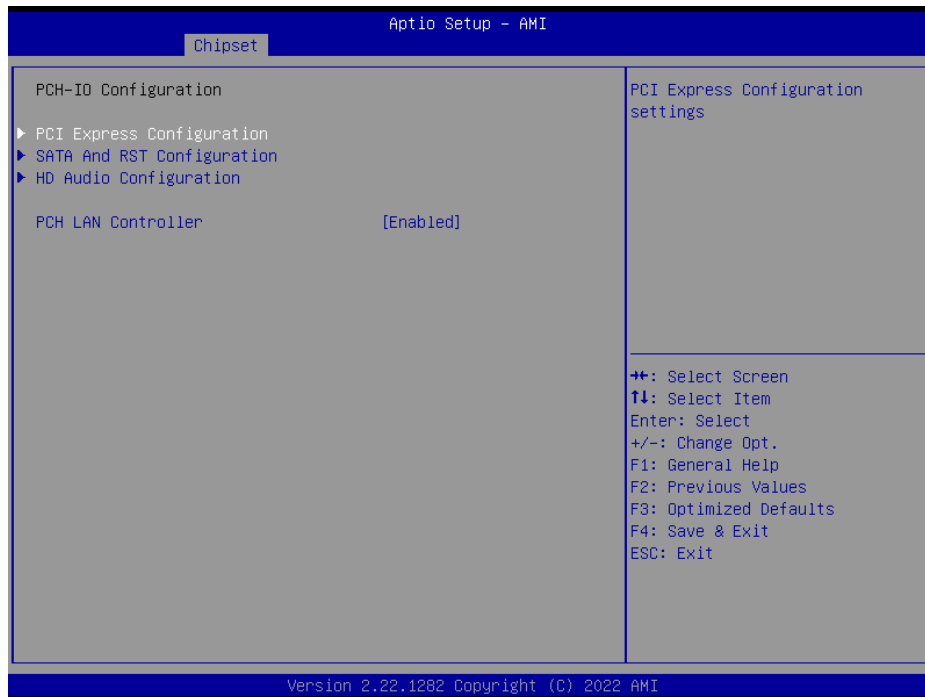

5.6.3.2.1 PCI Express Configuration



5.6.3.2.1.1 PCI Express Root Port 5(LAN1-I225/I226)

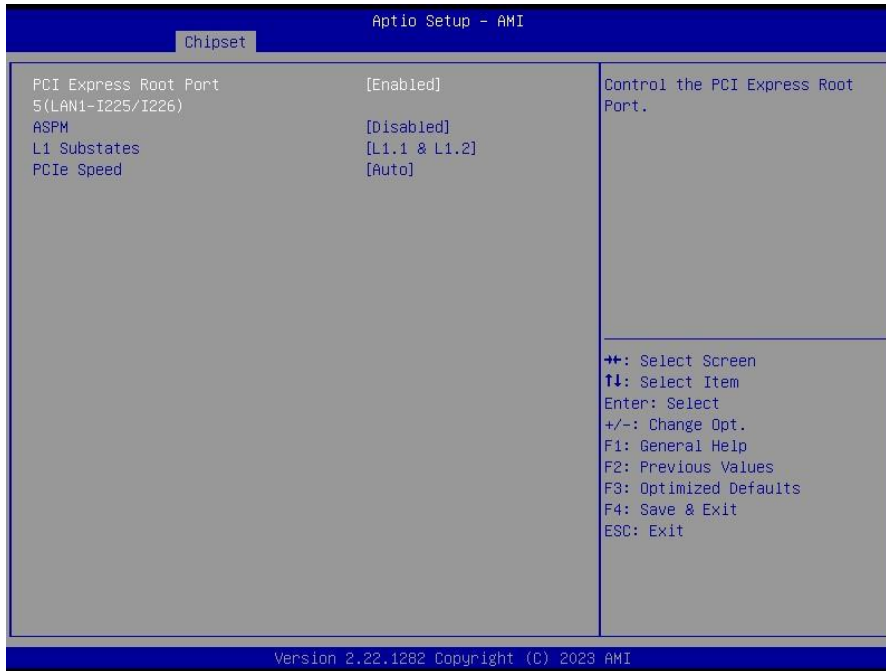

| Item | Option | Description |
|--|---|--|
| PCI Express Root Port 5(LAN1-I225/I226) | Enabled [Default] , Disabled | Control the PCI Express Root Port. |
| ASPM | Disabled [Default] , L0s L1 L0sL1 Auto | Set the ASPM Level: Force L0s – Force all links to L0s State AUTO – BIOS auto configure DISABLE – Disables ASPM. |
| L1 Substates | Disabled L1.1 L1.1 & L1.2 [Default] | PCI Express L1 Substates settings. |
| PCIe Speed | Auto [Default] Gen1 Gen2 Gen3 | Configure PCIe Speed. |

5.6.3.2.1.2 PCI Express Root Port 6(M.2 KeyE)

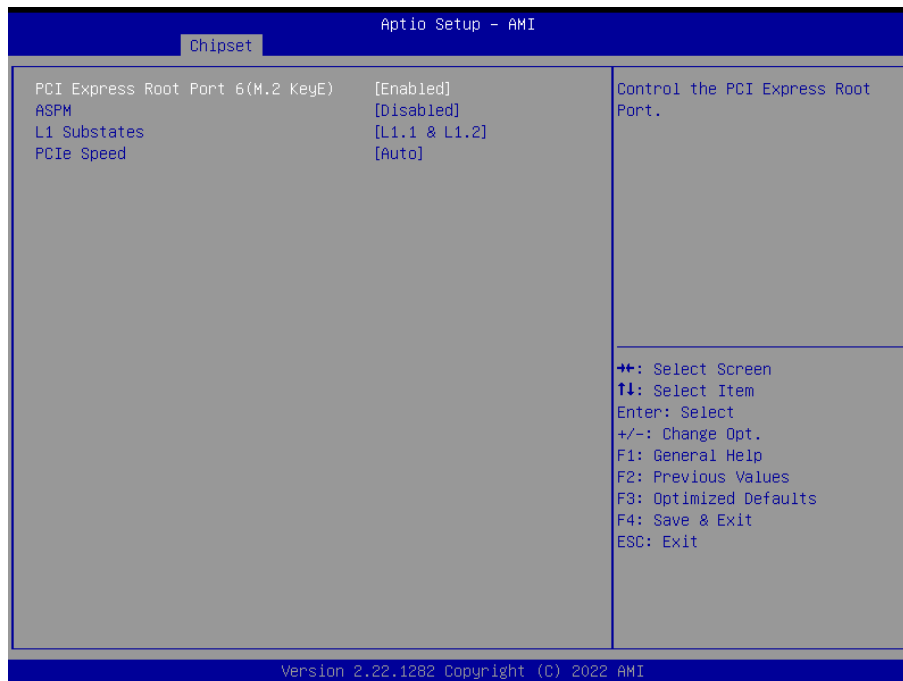

| Item | Option | Description |
|--|--|--|
| PCI Express Root Port 6(M.2 KeyE) | Enabled[Default], Disabled | Control the PCI Express Root Port. |
| ASPM | Disabled[Default], L0s L1 L0sL1 Auto | Set the ASPM Level: Force L0s – Force all links to L0s State AUTO – BIOS auto configure DISABLE – Disables ASPM. |
| L1 Substates | Disabled L1.1 L1.1 & L1.2[Default] | PCI Express L1 Substates settings. |
| PCIe Speed | Auto[Default] Gen1 Gen2 Gen3 | Configure PCIe Speed. |

5.6.3.2.1.3 PCI Express Root Port 8(JB2B1)



| Item | Option | Description |
|---------------------------------------|---|--|
| PCI Express Root Port 8(JB2B1) | Enabled [Default] , Disabled | Control the PCI Express Root Port. |
| ASPM | Disabled [Default] , L0s L1 L0sL1 Auto | Set the ASPM Level: Force L0s – Force all links to L0s State AUTO – BIOS auto configure DISABLE – Disables ASPM. |
| L1 Substates | Disabled L1.1 L1.1 & L1.2 [Default] | PCI Express L1 Substates settings. |
| PCIe Speed | Auto [Default] Gen1 Gen2 Gen3 | Configure PCIe Speed. |

5.6.3.2.2 SATA And RST Configuration

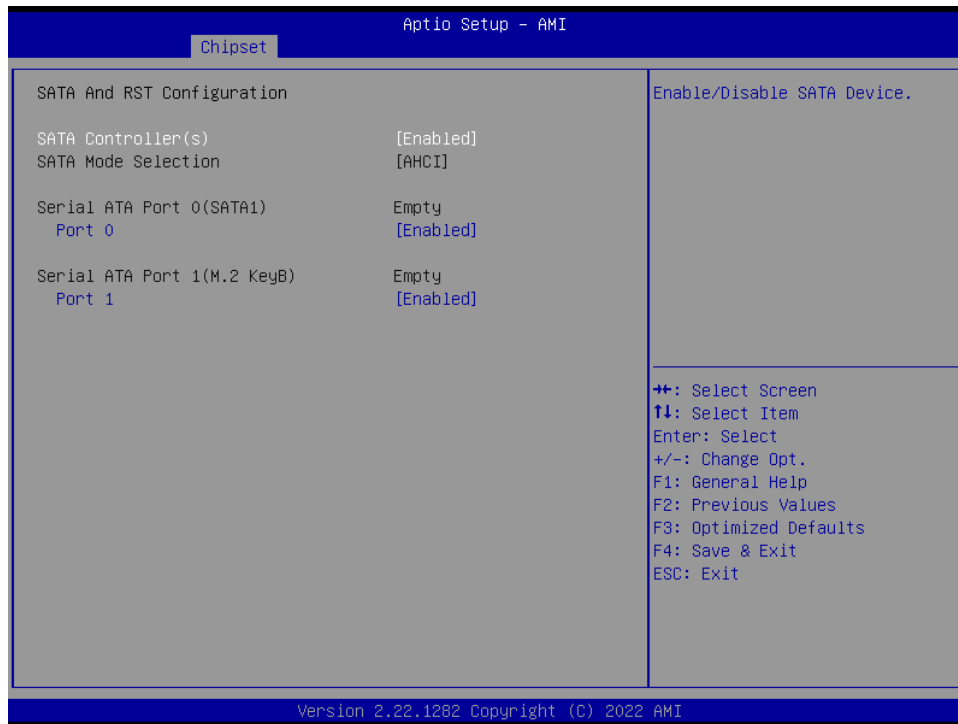

| Item | Options | Description |
|---------------------------|--|------------------------------|
| SATA Controller(s) | Enabled[Default] Disabled, | Enable/Disable SATA Device. |
| Port 0 | Enabled[Default] Disabled | Enable or Disable SATA Port. |
| Port 1 | Enabled[Default] Disabled | Enable or Disable SATA Port. |

5.6.3.2.3 HD Audio Configuration

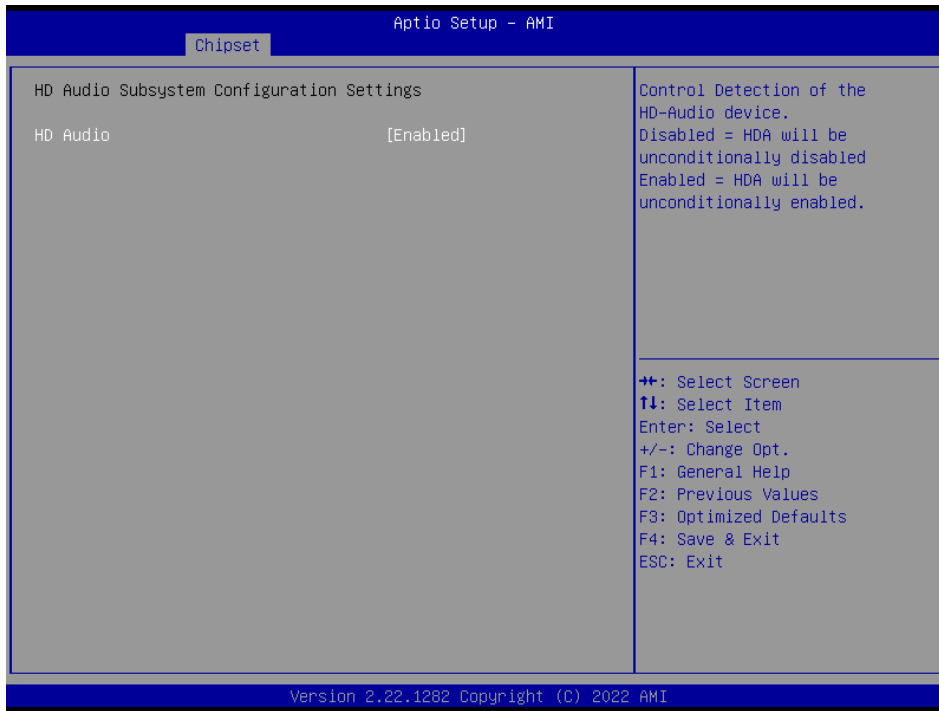

| Item | Option | Description |
|----------|------------------------------|--|
| HD Audio | Disabled Enabled[Default] | Control Detection of the HD-Audio device. Disable = HDA will be unconditionally disabled. Enabled = HDA will be unconditionally enabled. |

5.6.3.3 Board & Panel Configuration

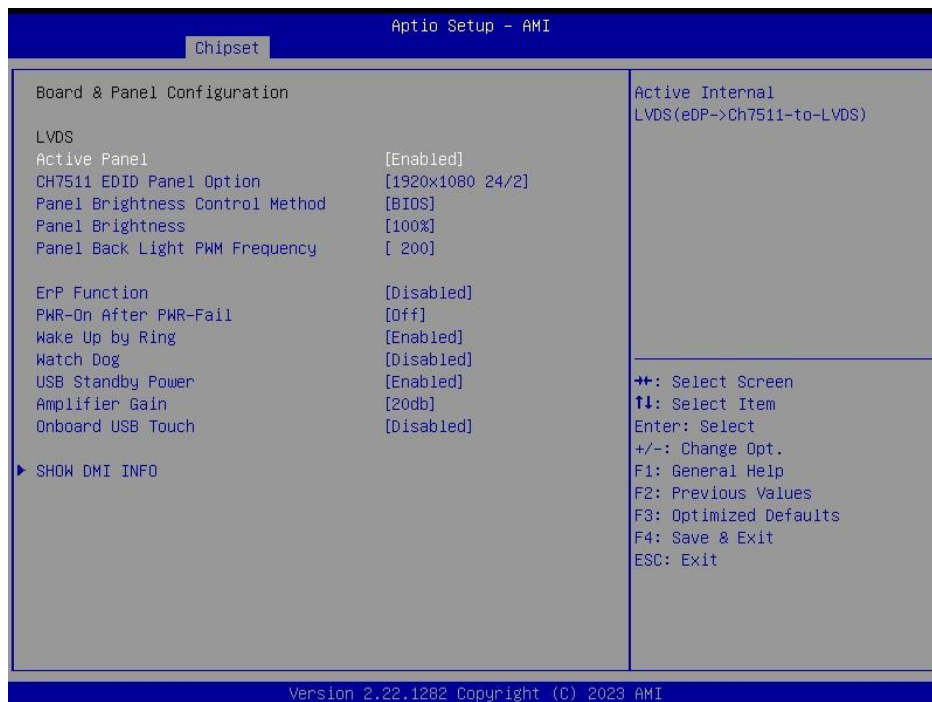

| Item | Option | Description |
|--|---|---|
| Active Panel | Disabled Enabled[Default] | Active Internal LVDS(eDP->Ch7511-to-LVDS). |
| CH7511 EDID Panel Option | 1024x768 24/1 800x600 18/1 1024x768 18/1 1366x768 18/1 1024x600 18/1 1280x800 18/1 1920x1200 24/2 1920x1080 18/2 1280x1024 24/2 1440x900 18/2 1600x1200 24/2 1366x768 24/1 1920x1080 24/2[Default] 1680x1050 24/2 | Port-EDP to LVDS(Chrotel 7511) Panel EDID Option. |
| Panel Brightness Control Method | BIOS[Default] OS Driver | Panel Brightness Control Method. 1.BIOS 2.OS Driver. |
| Panel Brightness | 00% 25% 50% 75% 100%[Default] | Select Panel(eDP/LVDS) back light PWM duty. |
| Panel Back Light PWM Frequency | 200[Default] 300 400 500 700 1k 2k 3k 5k 10k 20k | Select Panel(eDP/LVDS) back light PWM Frequency. |
| ErP Function | Disabled[Default] Enabled | ErP Function (Deep S5). |
| PWR-On After PWR-Fail | Off[Default] On Last state | AC loss resume. |
| Wake Up by Ring | Disabled Enabled[Default] | Wake Up by Ring from S3/S4/S5. |
| Watch Dog | Disabled[Default] 30 sec 40 sec 50 sec 1 min 2 min 10 min 30 min | Select WatchDog. |

ARC-21W38

| | | |
|--------------------------|---------------------------------------|--|
| USB Standby Power | Disabled Enabled[Default] | Enable/Disabled USB Standby Power during S3/S4/S5. |
| Amplifier Gain | 20db[Default] 26db | Amplifier Gain adjust. |
| Onboard USB Touch | Disabled Enabled[Default] | Onboard USB Touch Enabled/Disabled. |

5.6.3.3.1 SHOW DMI INFO

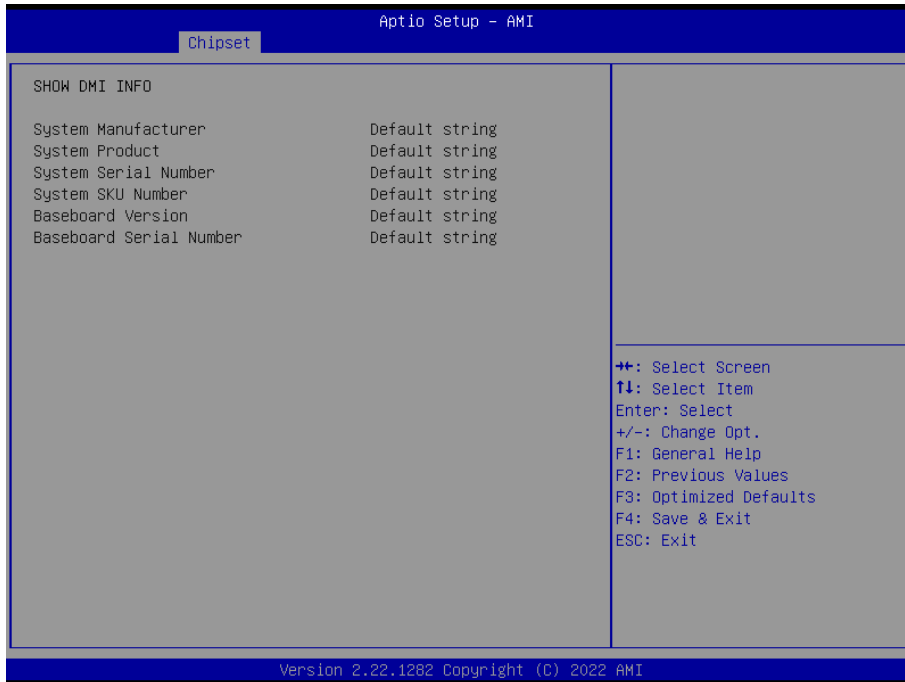

5.6.4 Security



- **Administrator Password**

Set setup Administrator Password

- **User Password**

Set User Password

5.6.4.1 Secure Boot

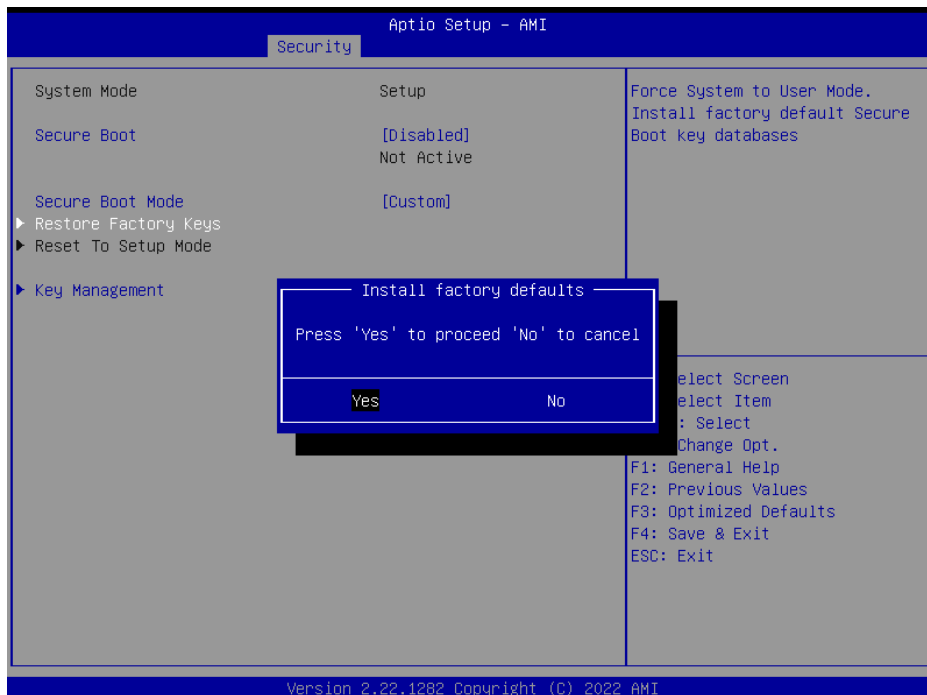

ARC-21W38

| Item | Option | Description |
|-------------------------|---------------------------------------|---|
| Secure Boot | Disabled[Default] Enabled | Secure Boot feature is Active if Secure Boot is Enable, Platform Key(PK) is enrolled and the System is in User mode. The mode change requires platform reset. |
| Secure Boot Mode | Standard Custom[Default] | Secure Boot mode selector: Standard/Custom. In Custom mode Secure Boot Variables can be configured without authentication. |

5.6.4.1.1 Key Management

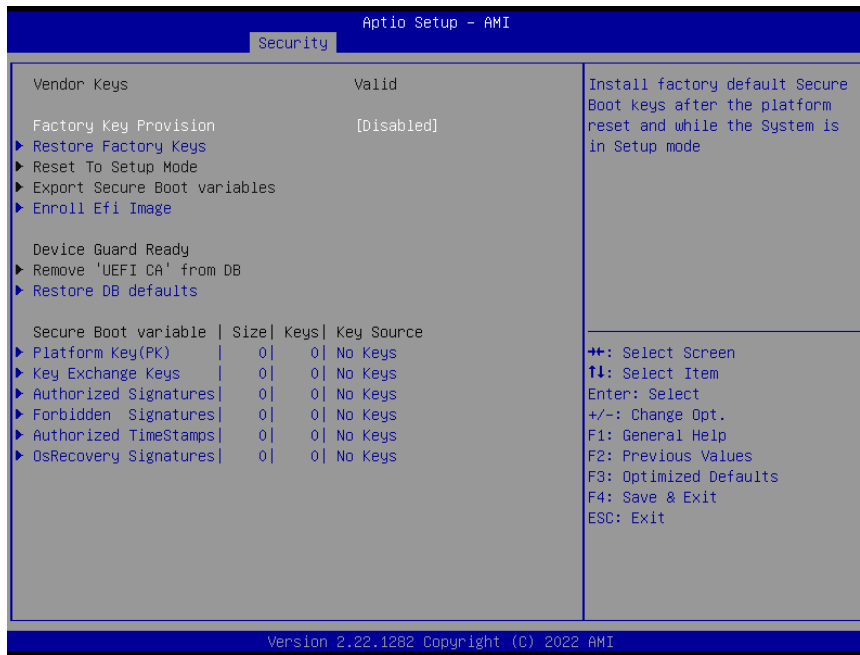

| Item | Option | Description |
|------------------------------|---------------------------------------|--|
| Factory Key Provision | Disabled[Default] Enabled | Install factory default Secure Boot keys after the platform reset and while the System is in Setup mode. |

5.6.5 Boot

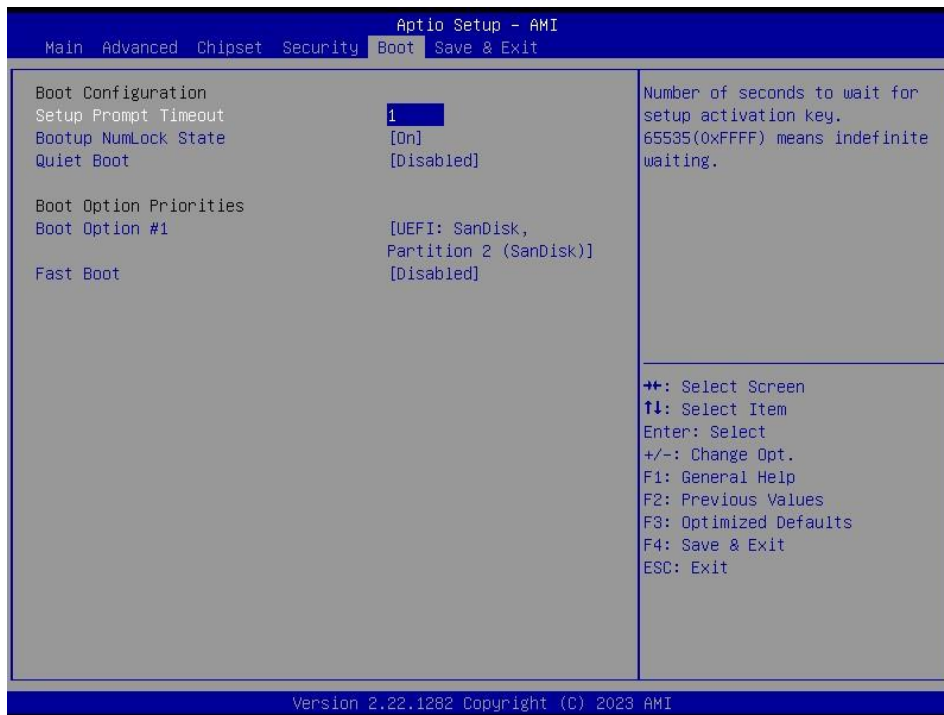

| Item | Option | Description |
|-----------------------------|------------------------------|---|
| Setup Prompt Timeout | 1~ 65535 | Number of seconds to wait for setup activation key. 65535(0xFFFF) means indefinite waiting. |
| Bootup NumLock State | On[Default] Off | Select the keyboard NumLock state |
| Quiet Boot | Disabled[Default] Enabled | Enables or disables Quiet Boot option |
| Fast Boot | Disabled[Default] Enabled | Enables or disables boot with initialization of a minimal set of devices required to launch active boot option. Has no effect for BBS boot options. |
| Boot Option #1 | Set the system boot order. | |

5.6.6 Save and exit

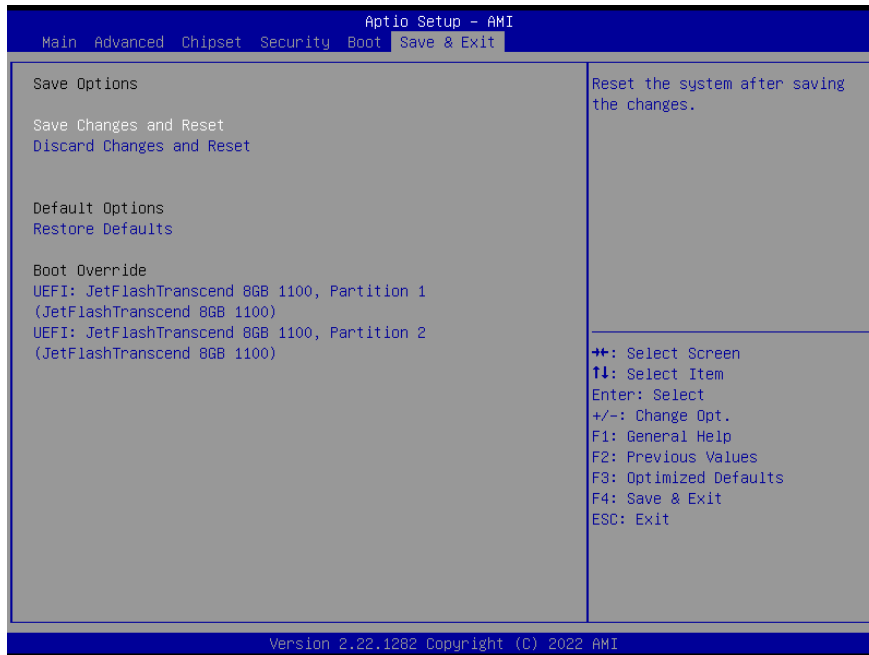

5.6.6.1 Save Changes and Reset

Reset the system after saving the changes.

5.6.6.2 Discard Changes and Reset

Any changes made to BIOS settings during this session of the BIOS setup program are discarded. The setup program then exits and reboots the controller.

5.6.6.3 Restore Defaults

This option restores all BIOS settings to the factory default. This option is useful if the controller exhibits unpredictable behavior due to an incorrect or inappropriate BIOS setting.

5.6.6.4 Launch EFI Shell from filesystem device

Attempts to Launch EFI Shell application (Shellx64.efi) from one of the available filesystem devices.

6. Maintenance & Troubleshooting

System Maintenance Introduction

If the components of the product fail they must be replaced.

Please contact the system reseller or vendor to purchase the replacement parts. Please follow the safety precautions outlined in the sections that follow

General Safety Precautions

Please ensure the following safety precautions are adhered to at all times.

1. Follow the electrostatic precautions outlined below whenever the device is opened.
2. Make sure the power is turned off and the power cord is disconnected whenever the product is being installed, moved or modified.
3. To prevent the risk of electric shock, make sure power cord is unplugged from wall socket. To fully disengage the power to the unit, please disconnect the power cord from the AC outlet. Refer servicing to qualified service personnel. The AC outlet shall be readily available and accessible.
4. Do not apply voltage levels that exceed the specified voltage range. Doing so may cause fire and/or an electrical shock. Use a power cord that matches the voltage of the power outlet, which has been approved and complies with the safety standard of your particular country.
5. Electric shocks can occur if the product chassis is opened when it is running. To avoid risk of electric shock, this device must only be connected to a supply mains with protective earth.
6. Do not drop or insert any objects into the ventilation openings of the product.
7. If considerable amounts of dust, water, or fluids enter the device, turn off the power supply immediately, unplug the power cord, and contact your dealer or the nearest service center.
8. This equipment is not suitable for use in locations where children are likely to be present.
9. DO NOT:
 - Drop the device against a hard surface.
 - Strike or exert excessive force onto the LCD panel.
 - Touch any of the LCD panels with a sharp object.
 - In a site where the ambient temperature exceeds the rated temperature.

Anti-Static Precautions

WARNING:

Failure to take ESD precautions during the installation of the product may result in permanent damage to the product and severe injury to the user.

Electrostatic discharge (ESD) can cause serious damage to electronic components, including the product. Dry climates are especially susceptible to ESD. It is therefore critical that whenever the product is opened and any of the electrical components are handled, the following anti-static precautions are strictly adhered to.

- **Wear an anti-static wristband:** Wearing a simple anti-static wristband can help to prevent ESD from damaging any electrical component.
- **Self-grounding:** Before handling any electrical component, touch any grounded conducting material. During the time the electrical component is handled, frequently touch any conducting materials that are connected to the ground.
- **Use an anti-static pad:** When configuring or working with an electrical component, place it on an anti-static pad. This reduces the possibility of ESD damage.
- **Only handle the edges of the electrical component.** When handling the electrical component, hold the electrical component by its edges. Please ensure the following safety precautions are adhered to at all times.

Maintenance and Cleaning

When maintaining or cleaning the product, please follow the guidelines below.

WARNING:

- For safety reasons, turn-off the power and unplug the panel PC before cleaning.
- If you dropped any material or liquid such as water onto the panel PC when cleaning, unplug the power cable immediately and contact your dealer or the nearest service center. Always make sure your hands are dry when unplugging the power cable.

Maintenance and Cleaning

Prior to cleaning any part or component of the product, please read the details below.

- Except for the LCD panel, never spray or squirt liquids directly onto any other components. To clean the LCD panel, gently wipe it with a piece of soft dry cloth or a slightly moistened cloth.
- The interior of the device does not require cleaning. Keep fluids away from the device interior.
- Be cautious of all small removable components when vacuuming the device.
- Never drop any objects or liquids through the openings of the device.
- Be cautious of any possible allergic reactions to solvents or chemicals used when cleaning the device.
- Avoid eating, drinking and smoking within vicinity of the device.

Cleaning Tools

Some components in the panel PC may only be cleaned using a product specifically designed for the purpose. In such case, the product will be explicitly mentioned in the cleaning tips. Below is a list of items to use when cleaning the panel PC.

- Cloth: Although paper towels or tissues can be used, a soft, clean piece of cloth is recommended when cleaning the device.
- Water or rubbing alcohol: A cloth moistened with water or rubbing alcohol can be used to clean the device.
- Using solvents: The use of solvents is not recommended when cleaning the device as they may damage the plastic parts.
- Vacuum cleaner: Using a vacuum specifically designed for computers is one of the best methods of cleaning the device. Dust and dirt can restrict the airflow in the device and cause its circuitry to corrode.
- Cotton swabs: Cotton swabs moistened with rubbing alcohol or water are excellent tools for wiping hard to reach areas.
- Foam swabs: Whenever possible, it is best to use lint free swabs such as foam swabs for cleaning.

Basic Troubleshooting

PEI Beep Codes

| # of Beeps | Description |
|------------|--|
| 1 | Memory not Installed |
| 2 | Recovery started |
| 3 | Typically for development use. The beep code is generated when DXE IPL PPI or DXE Core is not found. |
| 4 | Recovery failed |
| 4 | S3 Resume failed |
| 7 | Typically for development use. The beep code is generated when platform cannot be reset because reset PPI is not available. |

DXE Beep Codes

| # of Beeps | Description |
|------------|---|
| 1 | Invalid password |
| 4 | Typically for development use. The beep code is generated when some of the Architectural Protocols are not available. |
| 5 | No Console Input or Output Devices are found |
| 5 | No Console Input Devices are found |
| 6 | Flash update is failed |
| 7 | Typically for development use. The beep code is generated when platform cannot be reset because reset protocol is not available. |
| 8 | Platform PCI resource requirements cannot be met |

7. Product Application

For detailed instructions on the operation of the Watchdog Timer and Digital I/O (DIO) features of this Panel PC, please refer to the comprehensive guide available in the "AvalueIOAPI" manual. Please reaching out to your respective distributors, Avalue technical support team, or Avalue customer service representatives for further information. Feel free to inquire about this supplementary resource to enhance your understanding of the Watchdog Timer and Digital I/O (DIO) Application for optimal utilization of your Panel PC.

8. Operating the Device

The Multi-Touch mode was pre-installed on the Panel PC and need tools for any customizations. Should you have specific requirements or encounter scenarios where a customized touch mode is necessary, we recommend reaching out to your local distributors, Avalue technical support team, or Avalue customer service representatives. These professionals can provide tailored guidance and assistance to address any unique needs related to Multi-Touch mode adjustments.