

ARC-1535

15" Intel Atom® x6413E Processor Fanless Rugged Touch
Panel PC with IET Expansion

Quick Reference Guide

2nd Ed – 16 January 2024

Copyright Notice

Copyright © 2024 Avalue Technology Inc., ALL RIGHTS RESERVED.

Part No. E2017A550A1R

Document Amendment History

Revision	Date	By	Comment
1 st	February 2023	Avalue	Initial Release
2 nd	January 2024	Avalue	Add A/B Model

Declaration of Conformity



This device complies with part 15 fcc rules. Operation is subject to the following two conditions:

(1) This device may not cause harmful interference.

(2) This device must accept any interference received including interference that may cause undesired operation.

This equipment has been tested and found to comply with the limits for a class "a" digital device, pursuant to part 15 of the fcc rules.

These limits are designed to provide reasonable protection against harmful interference when the equipment is operated in a commercial environment. This equipment generates, uses, and can radiate radio frequency energy and, if not installed and used in accordance with the instruction manual, may cause harmful interference to radio communications.

Operation of this equipment in a residential area is likely to cause harmful interference in which case the user will be required to correct the interference at his own expense.

CE statement

The product(s) described in this manual complies with all application European Union (CE) directives if it has a CE marking. For computer systems to remain CE compliant, only CE-compliant parts may be used. Maintaining CE compliance also requires proper cable and cabling techniques.

Notice

This guide is designed for experienced users to setup the system within the shortest time. For detailed information, please always refer to the electronic user's manual.

Copyright Notice

© 2024 by Avalue Technology Inc. All rights are reserved. No parts of this manual may be copied, modified, or reproduced in any form or by any means for commercial use without the prior written permission of Avalue Technology Inc. All information and specification provided in this manual are for reference only and remain subject to change without prior notice.

Acknowledgements

Intel and Pentium are trademarks of Intel Corporation.

Microsoft Windows is registered trademark of Microsoft Corp.

All other product names or trademarks are properties of their respective owners.

Disclaimer

This manual is intended to be used as a practical and informative guide only and is subject

to change without notice. It does not represent a commitment on the part of Avalue. This product might include unintentional technical or typographical errors. Changes are periodically made to the information herein to correct such errors, and these changes are incorporated into new editions of the publication.

A Message to the Customer

Avalue Customer Services

Each and every Avalue's product is built to the most exacting specifications to ensure reliable performance in the harsh and demanding conditions typical of industrial environments. Whether your new Avalue device is destined for the laboratory or the factory floor, you can be assured that your product will provide the reliability and ease of operation for which the name Avalue has come to be known.

Your satisfaction is our primary concern. Here is a guide to Avalue's customer services. To ensure you get the full benefit of our services, please follow the instructions below carefully.

Technical Support and Assistance

1. Visit the Avalue website at <https://www.avalue.com.tw/> where you can find the latest information about the product.
2. Contact your distributor or our technical support team or sales representative for technical support if you need additional assistance. Please have following information ready before you call:
 - Product name and serial number
 - Description of your peripheral attachments
 - Description of your software (operating system, version, application software, etc.)
 - A complete description of the problem
 - The exact wording of any error messages

To receive the latest version of the user's manual; please visit our Web site at:

www.avalue.com

Product Warranty (Returns & Warranties policy)

1. Purpose

Avalue establishes the following maintenance specifications and operation procedures for providing the best quality of service and shortened repair time to our customers.

2. Warranty

2.1 Warranty Period

Avalue endeavors to offer customers the most comprehensive post-sales services and protection; besides offering a 2-year warranty for standard Avalue products, an extended warranty service can also be provided based on additional request from the customer. Within the warranty period, customers are entitled to receive comprehensive and prompt repair and warranty.

Standard products manufactured by Avalue are offered a 2-year warranty, from the date of delivery from Avalue. For ODM/OEM products manufactured by Avalue or PCBA with conformal coating, will follow up the define warranty of the agreement, otherwise will be offered 1-year warranty for ODM/OEM products but non-warranty for PCBA with conformal coating. For outsourcing parts kit by Avalue (ex: Motherboard, LCD touch panel, CPU, RAM, HDD) are offered a 6-month warranty, and Mobile/Tablet PC battery are offered a warranty of the half year, from the date of delivery by Avalue. Products before the mass production stage, i.e. engineering samples are not applied in this warranty or service policy. For extended warranty and cross-territory services, product defects resulting from design, production process or material are covered by the pre-set warranty period after the date of delivery from Avalue. For non-Avalue products, the product warranty and repair time shall be based on the service standards provided by the original manufacturer; in principle Avalue will provide these products a warranty service for no more than one year.

2.2 Maintenance services within the warranty period

In the case of Avalue product DOA (Defect-on-Arrival) when the customer finds any defect within 1 month after the delivery, Avalue will replace it with a new product in a soonest way. Except for custom products, once the customer is approved of a Cross-Shipment Agreement, which allows for delivery a new product to the customer before receiving the defective one, Avalue will immediately proceed with new product replacement for the said DOA case. On validation of the confirmed defect, Avalue is entitled to reserve the right whether to provide a new product for replacement. For the returned defective new product, it is necessary to verify that there shall be no bruise, alteration, scratch or marking to the appearance, and that none of the delivered accessories missing; otherwise, the customer will be requested to pay a processing fee. On the other hand, if the new product defect is resulting from incorrect configuration or erroneous use by the user instead of any problem of the hardware itself, the customer will also be requested to pay for relevant handling fees.

ARC-1535

As for other conditions, Avalue will handle defects by way of repair. The customer will be requested to send the defective product to an Avalue authorized service center, and Avalue will return the repaired product back to the customer as soon as possible.

2.3 Ruling of an out-of-warranty defect

The following situations are not included in the warranty:

- The warranty period has expired.
- Product has been altered or its label of the serial number has been torn off.
- Product functionality issues resulting from improper use by the user, unauthorized dismantle or alteration, unfit operation environment, improper maintenance, accident or other causes. Avalue reserves the right for the ruling of the aforementioned situations.
- Product damage resulting from lightning, flood, earthquake or other calamities.
- The warranty rules of non-Avalue products and accessories shall be in accordance with standards set up by the original manufacturer. These products and accessories include RAM, HDD, FDD, CD-ROM, CPU, FAN, etc.
- Product upgrade request or test request submitted by the customer after expiration of the warranty.
- PCBA with conformal coating.
- Avalue semi-product and outsourced products without Avalue serial number.
- Products before the mass production stage, i.e. engineering samples.

3. Procedure for sending for repair

3.1 Attain a RMA number

A customer's rejected product returned for repair shall have a RMA (Return Merchandise Authorization) number. Without a RMA number, Avalue will not provide any repair service for the rejected product, and the product will be returned to the customer at customer's cost. Avalue will not issue any notice for the return of the product.

Each returned product for repair shall have a RMA number, which is simply the authorization of the return for repair; it is not a guarantee that the returned goods can be repaired or replaced. For applying for a RMA number, the customer may enter the eRMA webpage of Avalue <https://myavalue.avalue.com.tw/> and log-in with an account number and a password authorized by Avalue. The system will then automatically issue a RMA number.

When applying for the RMA number, it is essential to fill in basic information of the customer and the product, together with detailed description of the problem encountered. If possible, avoid using ambiguous words such as "does not work" or "problematic". Without a substantial description of the problem, it is hard to start the repair and will cause prolonged repair time. Lacking detailed statement of fault steps also makes the problem hard to be identified, sometimes resulting in second-time repairs.

In case the customer can't define the cause of problem, please contact Avalue application engineers. Sometimes when the problem can be resolved even before the customer sends back the product.

On the other hand, if the customer only returns the key parts to Avalue for repair, it is necessary that the serial number of the entire unit is given in the "Problem Description" field, so that warranty period can be ruled accordingly; or Avalue will handle the case as an Out-of-warranty case.

3.2 Return of faulty product for repair

It is recommended that the customer not to return the accessories (manual, connection cables, etc.) with the products for repair, devices such as CPU, DRAM, CF memory card, etc., shall also be removed from the faulty goods before return for repair. If these devices are relevant to described repair problems and necessary to be returned with the goods; please clearly indicate the items included in the eRMA application form. Avalue shall not be responsible for any item that is not itemized. Moreover, make sure the problem(s) are detailed in the "Problem Description" field.

In the list of delivery, the customer may fill-in a value which is lower than the actual value, to prevent customs levying a higher tax over the excessive value of the return goods. The customer shall be held responsible for extra fees caused by this. We strongly recommend that "Invoice for customs purpose only with no commercial value" be indicated on the delivery note. Also for the purpose of expedited handling, please printout the RMA number and put it in the carton, also indicate the number outside of the carton, with the recipient addressing to Avalue RMA Department.

When returning the defective product, please use an anti-static bag or ESD material to pack it properly. In case of improper packing resulting in damages in the transportation process, Avalue reserves the right to reject the un-repaired faulty good at the customer's costs. Furthermore, it is suggested that the faulty goods shall be sent via a door-to-door courier service. The customer shall be held responsible for any customs clearance fee or extra expenses if Air-Cargo is used for the delivery.

In case of a DOA situation of a new product, Avalue will be responsible for the product and the freight. If the faulty goods are within the warranty period, the sender will take responsibility for the freight. For an out-of-warranty case, the customer shall be responsible for the freight of both trips.

3.3 Maintenance Charge

Avalue will charge a moderate repair fee for the following conditions:

- The warranty period has expired.
- Product has been altered or its label of the serial number has been torn off.
- Product functionality issues resulting from improper use by the user, unauthorized dismantle or alteration, unfit operation environment, improper maintenance, accident

ARC-1535

or other causes. Avalue reserves the right for the ruling of the aforementioned situations.

- Product damage resulting from lightning, flood, earthquake or other calamities.
- The warranty rules for non-Avalue products and accessories shall be in accordance with standards set up by the original supplier. These products and accessories include RAM, HDD, FDD, CD-ROM, CPU, FAN, etc.
- Product upgrade request or test request submitted by the customer after expiry of the warranty.
- PCBA with conformal coating.
- Avalue semi-product and outsourced products without Avalue serial number
- Products before the mass production stage, i.e. engineering samples.
- In case the products received are examined as NPF (No Problem Found) within the warranty period, the customer shall be responsible for the freight of both trips.
- Please contact your local distributor to examine in advance to prevent unnecessary freight cost.

For system failure of out-of-warranty products, Avalue will provide a quotation prior to repair service. When the customer applies for the cost, please refer to the Quotation number. In case the customer does not return the DOA product that has already been replaced by a new one, or the customer does not sign back the quotation of the out-of-warranty maintenance, Avalue reserves the right of whether or not to provide the repair service. In case the customer does not reply in 3 months, Avalue shall directly scrap or return the product back to customer at customer's cost without further notice to the customer.

3.4 Maintenance service of phased-out products

For servicing phased-out products, Avalue provides an extended period, starting the date of phase-out, as a guaranteed maintenance period of such products, for continuance of the maintenance service to meet customer's requirements. In case of unexpected factors causing Avalue to be unable to repair/replace a warranted but phased-out product, Avalue will, depending on the availability, upgrade the product (free of charge with continued warranty period as of the original product), or, give partial refund (based on the length of the remaining warranty period) to solve this kind of problem.

3.5 Maintenance Report

On completion of repair of a defective product, a Maintenance Report indicating the maintenance result and part(s) replaced (if any) will be sent to the customer together with the product. If the customer demands an additional maintenance analysis report, a service fee of various level will be charged depending on the warranty status. In case the analysis result shows that the defect attributes to Avalue's faulty design or process, the analysis fee will be exempted.

4. Service Products

Avalue provides service products to manage with different customer needs. Should you have any need, please consult to Avalue Sales Department.

Defect Analysis Report (DAR)

Avalue provides DAR (Defect Analysis Report) services aiming to elevating customer satisfaction. A DAR includes defect cause identification/verification/suggestion and improvement precautions, with instructions on correct usage for the avoidance of any reoccurrence.

Upgrade Service

Avalue is capable to provide system upgrade service for customization requirements. This upgrade service is applicable for main parts, such as CPU, memory, HDD, SSD, storage devices; also replacements motherboards of systems. Please contact Avalue sales for details to evaluate the possibility of system upgrade service and obtain information of lead time and price.

Safety Instructions

Safety Precautions

Before installing and using this device, please note the following precautions.

1. Read these safety instructions carefully.
2. Keep this User's Manual for future reference.
3. Disconnected this equipment from any AC outlet before cleaning.
4. For plug-in equipment, the power outlet socket must be located near the equipment and must be easily accessible.
5. Keep this equipment away from humidity.
6. Put this equipment on a reliable surface during installation. Dropping it or letting it fall may cause damage.
7. Make sure the voltage of the power source is correct before connecting the equipment to the power outlet.
8. Use a power cord that has been approved for using with the product and that it matches the voltage and current marked on the product's electrical range label. The voltage and current rating of the cord must be greater than the voltage and current rating marked on the product.
9. Position the power cord so that people cannot step on it. Do not place anything over the power cord.
10. All cautions and warnings on the equipment should be noted.
11. If the equipment is not used for a long time, disconnect it from the power source to

ARC-1535

avoid damage by transient overvoltage.

12. Never pour any liquid into an opening. This may cause fire or electrical shock.











13. Never open the equipment. For safety reasons, the equipment should be opened only by qualified service personnel. If one of the following situations arises, get the equipment checked by service personnel:

- The power cord or plug is damaged.
- Liquid has penetrated into the equipment.
- The equipment has been exposed to moisture.
- The equipment does not work well, or you cannot get it work according to the user's manual.
- The equipment has been dropped and damaged.
- The equipment has obvious signs of breakage.





14. **CAUTION:** Danger of explosion if battery is incorrectly replaced. Replace only with the same or equivalent type recommended by the manufacturer.

15. Equipment intended only for use in a **RESTRICTED ACCESS AREA**.

Explanation of Graphical Symbols

	Warning	A WARNING statement provides important information about a potentially hazardous situation which, if not avoided, could result in death or serious injury.
	Caution	A CAUTION statement provides important information about a potentially hazardous situation which, if not avoided, may result in minor or moderate injury to the user or patient or in damage to the equipment or other property.
	Note	A NOTE provides additional information intended to avoid inconveniences during operation.
		Direct current.
		Alternating current
		Stand-by, Power on
		FCC Certification
		CE Certification
		Follow the national requirements for disposal of equipment.
		Stacking layer limit
		This side up

ARC-1535

		Fragile Packaging
		Beware of water damage, moisture-proof
		Carton recyclable
		Handle with care
		Follow operating instructions of consult instructions for use.

Disposing of your old product

WARNING:

There is danger of explosion if the battery is mishandled or incorrectly replaced. Replace only with the same type of battery. Do not disassemble it or attempt to recharge it outside the system. Do not crush, puncture, dispose of in fire, short the external contacts, or expose to water or other liquids. Dispose of the battery in accordance with local regulations and instructions from your service provider.

CAUTION:

- Lithium Battery Caution: Danger of explosion if battery is incorrectly replaced. Replace only with same or equivalent type. Dispose batteries according to manufacturer's instructions.
- Disposal of a BATTERY into fire or a hot oven, or mechanically crushing or cutting of a BATTERY, that can result in an EXPLOSION
- Leaving a BATTERY in an extremely high temperature surrounding environment that can result in an EXPLOSION or the leakage of flammable liquid or gas.
- A BATTERY subjected to extremely low air pressure that may result in an EXPLOSION or the leakage of flammable liquid or gas.

Mise en garde!

AVERTISSEMENT : Il existe un risque d'explosion si la batterie est mal manipulée ou remplacée de manière incorrecte. Remplacez uniquement par le même type de batterie. Ne le démontez pas et ne tentez pas de le recharger en dehors du système. Ne pas écraser, percer, jeter au feu, court-circuiter les contacts externes ou exposer à l'eau ou à d'autres liquides. Jetez la batterie conformément aux réglementations locales et aux instructions de votre fournisseur de services.

MISE EN GARDE:

- Pile au lithium Attention : Danger d'explosion si la pile n'est pas remplacée correctement. Remplacer uniquement par un type identique ou équivalent. Jetez les piles conformément aux instructions du fabricant.
- L'élimination d'une BATTERIE dans le feu ou dans un four chaud, ou l'écrasement ou le découpage mécanique d'une BATTERIE, pouvant entraîner une EXPLOSION
- Laisser une BATTERIE dans un environnement à température extrêmement élevée pouvant entraîner une EXPLOSION ou une fuite de liquide ou de gaz inflammable.
- UNE BATTERIE soumise à une pression d'air extrêmement basse pouvant entraîner une EXPLOSION ou une fuite de liquide ou de gaz inflammable.

Content

1. Getting Started	18
1.1 Safety Precautions	18
1.2 Packing List.....	18
1.3 System Specifications	20
1.4 System Overview	24
1.4.1 I/O View	24
1.5 System Dimensions	25
1.5.1 ARC-1535 (A Model (Resistive Touch))	25
1.5.2 ARC-1535 (WMB version)	26
1.5.3 ARC-1535 (B Model (P-cap Touch))	27
2. Hardware Configuration	28
2.1 ARC-1535 connector mapping	29
2.1.1 Serial port 1 connector (COM1).....	29
2.1.2 Serial port 2 connector (COM2).....	29
2.2 Powering On the System	30
2.3 ARC-EHL Overviews.....	31
2.4 ARC-EHL Jumper and Connector list.....	32
2.5 ARC-EHL Jumpers & Connectors settings.....	34
2.5.1 Serial port 1/2 pin9 signal select (JRI1/2).....	34
2.5.2 LCD backlight brightness adjustment (JSBKL1)	34
2.5.3 AT/ATX Input power select (JSATX1)	35
2.5.4 Serial port 1 in RS-232/422/485 mode (JCOM_SEL1).....	35
2.5.5 M.2 KEY power select (JP1).....	36
2.5.6 LCD Inverter connector (JBKL1)	36
2.5.7 Touch connector (JTP1) co-lay USB2.0 header (JUSB1)	37
2.5.8 On-board header for USB2.0 (JUSB2).....	37
2.5.9 LVDS connector (LVDS1).....	38
2.5.10 AMPLIFIER_R (JSPKR1)	39
2.5.11 AMPLIFIER_L (JSPKL1)	39
2.5.12 Battery connector (BT1)	40
2.5.13 SPI connector (JSPI1)	40
2.5.14 B2B connector (JB2B1)	41
2.5.15 General purpose I/O connector (JGPIO1).....	42
2.5.16 SATA Power connector (SATAPW1).....	42

2.5.17	Front Panel connector (JFP1)	43
2.5.18	ESPI connector (JESPI1)	43
2.5.19	EC connector (JEC1)	44
2.6	ARC-BYT DB-A/B/C/D/G/H/K Overviews	45
2.6.1	ARC-BYT DB-A	45
2.6.2	ARC-BYT DB-B	45
2.6.3	ARC-BYT DB-C	45
2.6.4	ARC-BYT DB-D	46
2.6.5	ARC-BYT DB-G	46
2.6.6	ARC-BYT DB-H	46
2.6.7	ARC-BYT DB-K	47
2.7	ARC-BYT DB-A/B/C/D/G/H/K Connector list	47
2.7.1	ARC-BYT DB-A	47
2.7.2	ARC-BYT DB-B	47
2.7.3	ARC-BYT DB-C	47
2.7.4	ARC-BYT DB-D	48
2.7.5	ARC-BYT DB-G	48
2.7.6	ARC-BYT DB-H	48
2.7.7	ARC-BYT DB-K	48
2.8	ARC-BYT DB-D Connectors settings	49
2.8.1	Serial Port 1 connector (D_COM1)	49
2.8.2	Serial Port 2 connector (D_COM2)	49
2.9	ARC-BYT DB-G Connectors settings	50
2.9.1	Serial Port 1 connector (G_COM1)	50
2.9.2	Serial Port 2 connector (G_COM2)	50
2.9.3	Serial Port 3 connector (G_COM3)	51
2.10	ARC-BYT DB-H Jumpers settings	51
2.10.1	USB Power selector (H_USB_PWR_SEL1)	51
2.11	ARC-BYT DB-H Connectors settings	52
2.11.1	Serial Port 1 connector (H_COM1)	52
2.11.2	Serial Port 2 connector (H_COM2)	52
2.12	ARC-BYT DB-K Connectors settings	53
2.12.1	Serial Port 1 connector (I_COM1)	53
2.12.2	Serial Port 2 connector (I_COM2)	53
3.	Installation	54
3.1	Installing Memory	56
4.	BIOS Setup	57
4.1	Introduction	58
4.2	Starting Setup	58
4.3	Using Setup	59

4.4	Getting Help	60
4.5	In Case of Problems.....	60
4.6	BIOS setup.....	61
4.6.1	Main Menu	61
4.6.1.1	System Language	62
4.6.1.2	System Date	62
4.6.1.3	System Time	62
4.6.2	Advanced Menu.....	62
4.6.2.1	CPU Configuration	63
4.6.2.2	Power & Performance	64
4.6.2.2.1	CPU – Power Management Control.....	64
4.6.2.2.1.1	View/Configure Turbo Options.....	65
4.6.2.2.2	GT – Power Management Control	66
4.6.2.3	PCH-FW Configuration.....	66
4.6.2.3.1	Firmware Update Configuration	67
4.6.2.3.2	PTT Configuration	67
4.6.2.4	Trusted Computing.....	68
4.6.2.5	APCI Settings	68
4.6.2.6	Super IO Configuration.....	69
4.6.2.6.1	Serial Port 1 Configuration	70
4.6.2.6.2	Serial Port 2 Configuration	70
4.6.2.6.3	Serial Port 3 Configuration	71
4.6.2.6.4	Serial Port 4 Configuration	71
4.6.2.6.5	Serial Port 5 Configuration	72
4.6.2.7	EC 5571 HW Monitor	72
4.6.2.8	S5 RTC Wake Settings	73
4.6.2.9	Serial Port Console Redirection	73
4.6.2.10	USB Configuration.....	74
4.6.2.11	Network Stack Configuration.....	75
4.6.3	Chipset.....	76
4.6.3.1	System Agent (SA) Configuration	76
4.6.3.1.1	Memory Configuration	77
4.6.3.1.2	Graphics Configuration.....	78
4.6.3.2	PCH-IO Configuration	78
4.6.3.2.1	PCI Express Configuration	79
4.6.3.2.1.1	PCI Express Root Port 3(LAN1-I225/I226)	79
4.6.3.2.1.2	PCI Express Root Port 4(LAN2-I225/I226)	80
4.6.3.2.1.3	PCI Express Root Port 5(M.2 KeyE).....	81
4.6.3.2.1.4	PCI Express Root Port 7(M.2 KeyB/B2B).....	82
4.6.3.2.2	SATA Configuration.....	83

4.6.3.2.3	USB Configuration.....	84
4.6.3.2.4	HD Audio Configuration	84
4.6.3.3	Board & Panel Configuration.....	85
4.6.4	Security	87
4.6.4.1	Secure Boot.....	87
4.6.4.1.1	Key Management	88
4.6.5	Boot.....	89
4.6.6	Save and exit	90
4.6.6.1	Save Changes and Reset	91
4.6.6.2	Discard Changes and Reset	91
4.6.6.3	Restore Defaults.....	91
4.6.6.4	Launch EFI Shell from filesystem device	91
5.	Maintenance & Troubleshooting.....	92
6.	Product Application	98
7.	Operating the Device	99

1. Getting Started

1.1 Safety Precautions

Warning!



Always completely disconnect the power cord from your chassis whenever you work with the hardware. Do not make connections while the power is on. Sensitive electronic components can be damaged by sudden power surges. Only experienced electronics personnel should open the PC chassis.

Caution!



Always ground yourself to remove any static charge before touching the CPU card. Modern electronic devices are very sensitive to static electric charges. As a safety precaution, use a grounding wrist strap at all times. Place all electronic components in a static-dissipative surface or static-shielded bag when they are not in the chassis.

1.2 Packing List

Before installation, please ensure all the items listed in the following table are included in the package.

Item	Description	Q'ty
1	ARC-1535 Panel PC	1
2	Power Adapter	1
3	Screws for VESA	4



If any of the above items is damaged or missing, contact your retailer.

Purposes and Applications

ARC-1535 is used the Intel Atom® X-series (Elkhart Lake platform), which has stronger performance and lower power consumption. It also inherits from ARC-series strength, Modularized, Flexible Expansion, Reliability and Stability.

ARC series have been passed stricter vibration and shock testing. It can be used on extreme environment like manufacture or factory. Typical applications are HMI, Automation, POI, KIOSK.

It also can be suitable for the customer's various application and scenario that need more ruggedized, vibration and water/dust-proof environment (IP65 Front Panel, IP41 Rear (except I/O)).

Unpacking

Note:

If any of the components listed in the checklist below are missing, do not proceed with the installation. Contact the Avalue reseller or vendor the product was purchased from or contact an Avalue sales representative directly by sending an email to sales@avalue.com.tw.

To unpack the flat bezel panel PC, follow the steps below.

WARNING!

The front side LCD screen has a protective plastic cover stuck to the screen. Only remove the plastic cover after the flat bezel panel PC has been properly installed. This ensures the screen is protected during the installation process.

Step 1: Carefully cut the tape sealing the box. Only cut deep enough to break the tape.

Step 2: Open the outside box.

Step 3: Carefully cut the tape sealing the box. Only cut deep enough to break the tape.

Step 4: Open the inside box.

Step 5: Lift the panel PC out of the boxes.

Step 6: Remove the peripheral parts box from the main box.

1.3 System Specifications

Component	
Mother Board	ARC-EHL
CPU	Onboard Intel® Elkhart Lake Processor Intel Atom® x6211E Processor (6W, 1.5M Cache, up to 3.00 GHz) Intel Atom® x6413E Processor (9W, 1.5M Cache, up to 3.00 GHz) Intel Atom® x6425E Processor (12W, 1.5M Cache, up to 3.00 GHz)
CPU Cooler (Type)	Fanless Heatsink
Memory	1 x 260-pin DDR4 3200 MHz SO-DIMM socket, supports up to 32GB Max (In-BEND ECC supported)
Power Supply	Wide Range DC Power Input from 12~24v in
Adapter	AC/DC adapter 19V/3.78A Screw Type, 72W power adaptor
System Fan	Fanless
Speaker	2W*2
Wireless LAN	Default N/A; Optional support by M.2 Key-E 2230 slot (Support PCIe1, USB2.0 Wi-Fi/BT module)
Bluetooth	Default N/A; Optional support by M.2 Key-E 2230 slot (Support PCIe1, USB2.0 Wi-Fi/BT module)
Operating System	Windows 10/11 Linux
Expansion Card	2 x M.2 Slots: 1 x M.2 Key-B, 2242/3042/3052, support SATAIII USB2.0, SIM Slot for LTE Cards BOM option for PCIe1 or USB3.2 Gen1x1 (*Default PCIe1 is for IET CON., Option for M.2 Key-B PCIe or USB) 1 x M.2 Key-E, 2230, support PCIe1, USB2.0 1 x 80-pin Expansion IET interface
Other Component	SIM card slot (for 4G or 5G module) for M.2 Key-B 2242/3042/3052
TPM	TPM 2.0 (by default)
Storage	
Hard Disk Drive	1 x 2.5" Drive Bay
Solid State Drive	1 x 2.5" Drive Bay
Other Storage Device	1 x M.2 Key-B 2242/3042/3052 for M.2 SATAIII SSD
Panel	

LCD Panel	A model (Resistive Touch): 15" XGA TFT LED Panel, 500 nits B model (P-cap Touch): 15" XGA TFT LED Panel, 300 nits
B/L Inverter/Converter	Panel built in
Touch Screen	A model (Resistive Touch): 5-wire resistive touch screen B model (P-cap Touch): 15" PCAP
Touch Controller	A model (Resistive Touch): PenMount B model (P-cap Touch): ILITEK
External I/O	
Serial Port	1 x DB-9 COM1 (RS-232/422/485, selectable by BIOS & JUPMER, RS-485 supports Auto Flow, Pin-9 selected for Ring/+5V/+12V by Jumper) 1 x DB-9 COM2 (RS-232, Pin-9 selected for Ring/+5V/+12V by Jumper)
USB Port	4 x USB3.2 Gen2x1 (10Gbp/s, 2 x Dual Deck, Type A)
DIO Port	1 x 8 bit GPIO (by onboard JGPIO1 wafer 6Px2) 12-bit GPIO + 2-pin CAN Bus (by ARC-BYT DB-E)
Video Port	(Option By IET module only, (DB-B, DB-C) (Option By IET module only, AUX-080 (for 2xHDMI)
Audio Port	Realtek ALC888S & 897 co-layout (or other option decided by Avalue)
LAN Port	2 x Intel® I225-IT 2.5 Gigabit Ethernet
Wireless LAN Antenna	5 x Antenna hole on Top of back cover 2 x Antenna hole on empty IET bracket
Indicator Light	HDD LED, Power LED (Green for Power, Yellow for HDD)
Expansion Slots	2 x M.2 Slots: 1 x M.2 Key-B, 2242/3042/3052, support SATAIII USB2.0, SIM Slot for LTE Cards BOM option for PCIe1 or USB3.2 Gen1x1 (*Default PCIe1 is for IET CON., Option for M.2 Key-B PCIe or USB) 1 x M.2 Key-E, 2230, support PCIe1, USB2.0 1 x 80-pin Expansion IET interface
Mechanical	
Power Type	ATX/AT by jumper (Default ATX)
Power button	1 x Power Switch on the side
Power Connector Type	Lockable DC in power jack (phoenix connector by option)

ARC-1535

Dimension	A model (Resistive Touch): 350 x 273.9 x 54.5 mm B model (P-cap Touch): 350.51 x 274.51 x 56.5 mm
Weight	3.7 Kgs
Color	A model (Resistive Touch): Front is Silver Aluminum; Rear is Black Casting-Aluminum B model (P-cap Touch): Die Casting with Cover lens
Fanless	Full System Fan-less
OS Support	Win 10/11 Linux
Reliability	
EMI Test	CE/ FCC class B
Dust and Rain Test	Front Panel IP65, Rear IP41 except I/O
Vibration Test	<p>Random Vibration Operation:</p> <ol style="list-style-type: none"> 1. PSD: 0.00454G²/Hz, 3 Grms 2. operation mode 3. Test Frequency: 5-500Hz 4. Test Axis: X,Y and Z axis 5. 30 minutes per each axis 6. IEC 60068-2-64 Test:Fh 7. Storage: SSD or M.2 SSD <p>Sine Vibration test (Non-operation)</p> <ol style="list-style-type: none"> 1 Test Acceleration: 2G 2 Test frequency: 5~500 Hz 3 Sweep : 1 Oct/ per one minute. (logarithmic) 4 Test Axis: X,Y and Z axis 5 Test time :30 min. each axis 6 System condition: Non-Operating mode 7. Reference IEC 60068-2-6 Testing procedures <p>Package vibration test</p> <ol style="list-style-type: none"> 1. PSD: 0.026G²/Hz, 2.16 Grms 2. Non-operation mode 3. Test Frequency: 5-500Hz 4. Test Axis: X,Y and Z axis 5. 30 min. per each axis 6. IEC 60068-2-64 Test:Fh
Mechanical Shock Test	<ol style="list-style-type: none"> 1. Wave form : Half Sine wave 2. Acceleration Rate : 20g for operation mode 3. Duration Time : 11ms

	<p>4. No. of Shock : +/- X,Y,Z axis 3 times</p> <p>5. Test Axis: +/- X,Y,Z axis</p> <p>6. Operation mode</p> <p>7. Reference IEC 60068-2-27 Testing procedures Test Eb: Shock Test</p>
Drop Test	<p>Package drop test</p> <p>Reference ISTA 2A, Method: IEC-60068-2-32 Test:Ed</p> <p>Test Ea : Drop Test</p> <p>1 Test phase: One corner, three edges, six faces</p> <p>2 Test high: 96.5cm</p> <p>3 Package weight: 5Kg</p> <p>4 Test drawing</p>
Operating Temperature	Wide temp.-20°C ~ 55°C (-4°F ~ 131°F)
Operating Humidity	40°C @ 95% Relative Humidity, Non-condensing
Storage Temperature	Wide temp.-30°C ~ 70°C(-22°F ~ 158°F)
Compliant with following Flexible Expansion Modules	
	Optional IET Module list:
ACC-ARC-USB-1R	IET DB-A 4 x USB3.0 kit for ARC Series (Unavailable when using M.2 key-B 5G module(PCIe changed to M.2 key-B))
ACC-ARC-AUDIO-1R	IET DB-B HDMI + 5.1 CH Audio Kit for ARC Series
ACC-ARC-MPCIE-1R	IET DB-C HDMI + MPCIE w/SIM Kit for ARC Series (Unavailable when using M.2 key-B 5G module(PCIe changed to M.2 key-B))
ACC-ARC-COM-1R	IET DB-D 2 x Isolated RS-232 Kit for ARC Series (ARC-EHL is used eSPI EC, so need to add eSPI to LPC IC for UART)
ACC-ARC-COM-2R	IET DB-G 3 x RS-232 Kit for ARC Series (ARC-EHL is used eSPI EC, so need to add eSPI to LPC IC for UART)
ACC-ARC-COM-3R	IET DB-H 2 x RS-232 + USB Kit for ARC Series (ARC-EHL is used eSPI EC, so need to add eSPI to LPC IC for UART)
ACC-ARC-COM-4R	IET DB-K 2 x RS-232 + LAN Kit for ARC Series (ARC-EHL is used eSPI EC, so need to add eSPI to LPC IC for UART) (Unavailable when using M.2 key-B 5G module(PCIe changed to M.2 key-B))
ACC-ARC-GPIO-1R	IET DB-E 12-bit GPIO + 2-pin CAN Bus Kit for ARC Series



Note: Specifications are subject to change without notice.

1.4 System Overview

1.4.1 I/O View

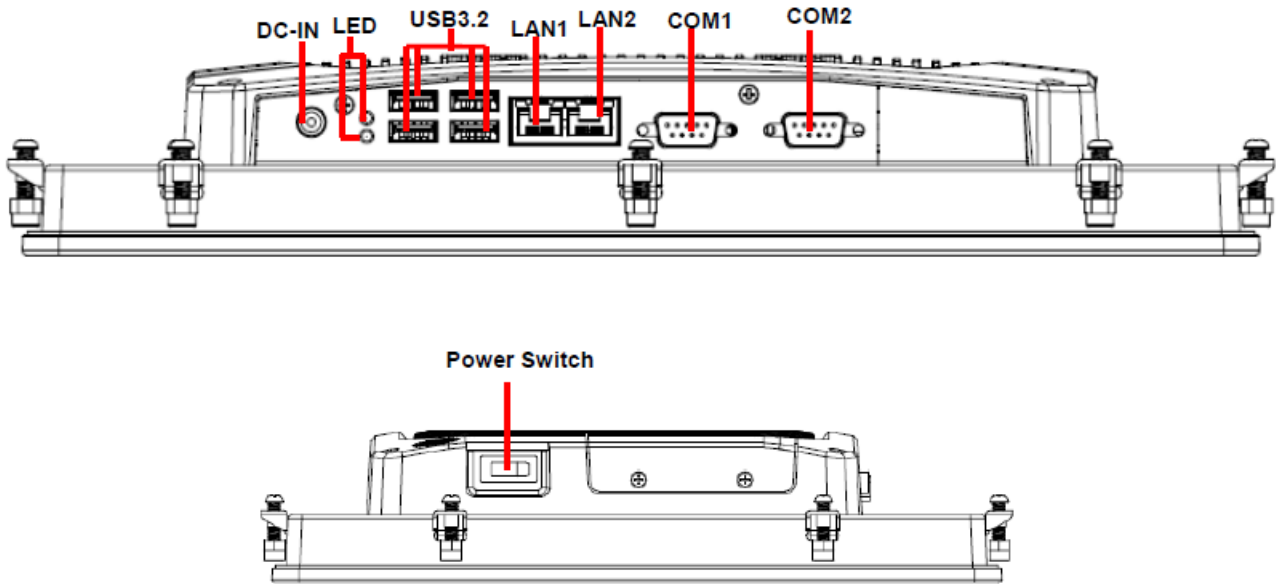

Connectors

Label	Function	Note
DC-IN	DC Power-in connector	Default: Lockable DC Jack Option: Phoenix Connector(MOQ apply)
COM1/2	Serial port 1/2 connector	DB-9 male connector
USB	4 x USB 3.2 connector	
LAN1/2	RJ-45 Ethernet 1/2	
LED	HDD/Power LED indicator	
Power Switch	Power on button	

1.5 System Dimensions

1.5.1 ARC-1535 (A Model (Resistive Touch))

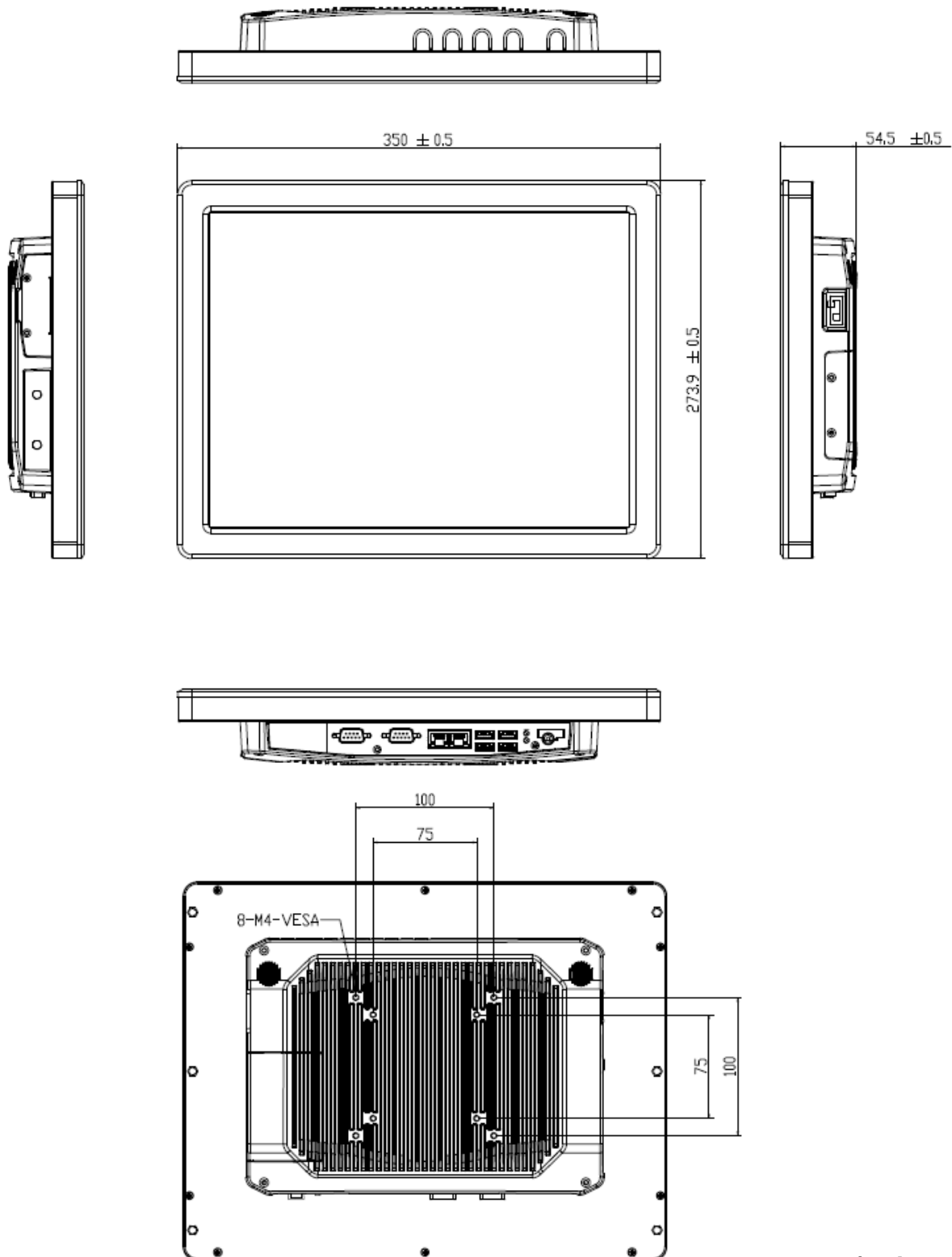

(Unit: mm)

ARC-1535

1.5.2 ARC-1535 (WMB version)

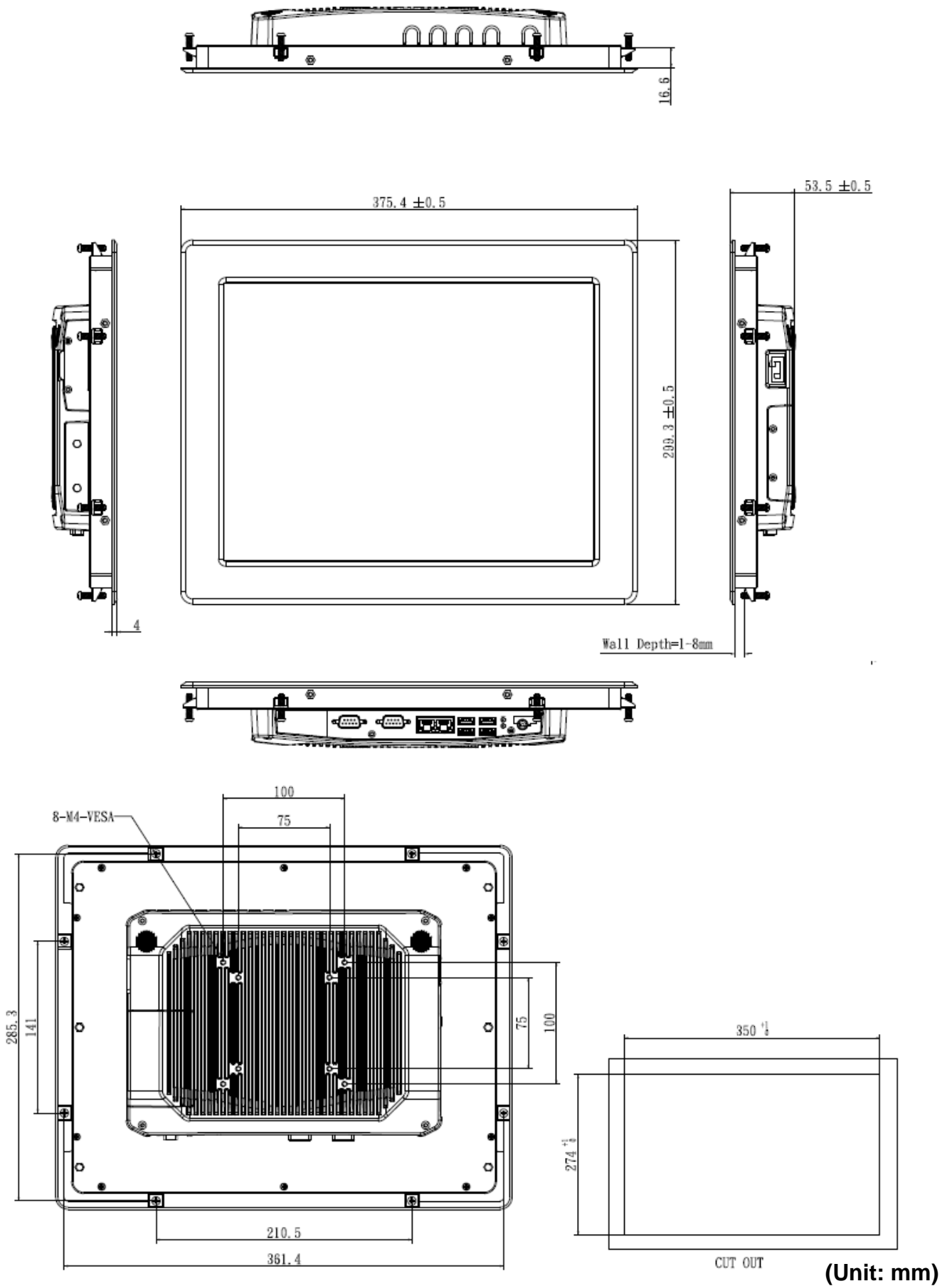

1.5.3 ARC-1535 (B Model (P-cap Touch))

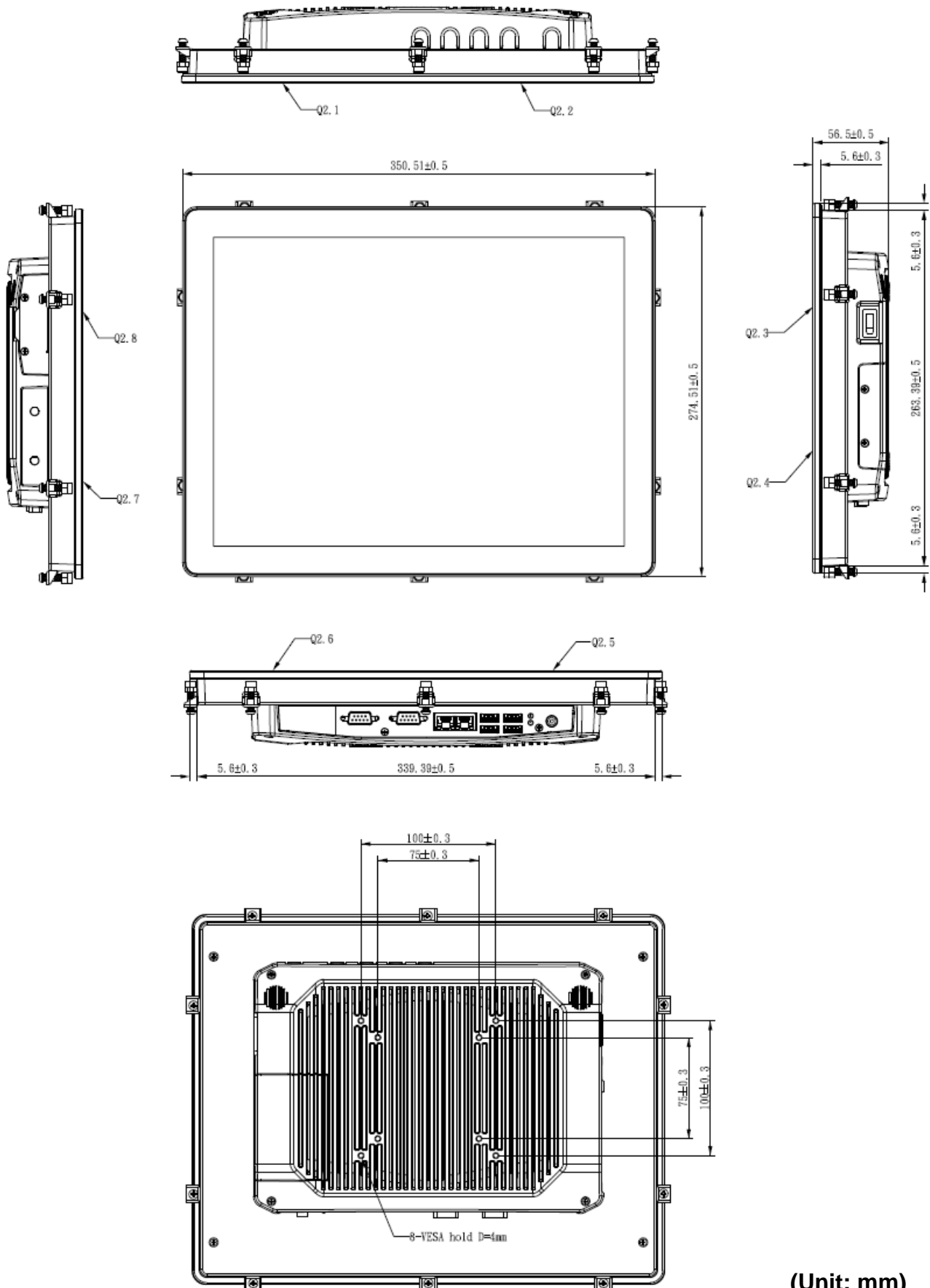

(Unit: mm)

2. Hardware Configuration

For advanced information, please refer to:

- 1- ARC-EHL, ARC-BYT DB-A/B/C/D/G/H/K included in this manual.



Note: If you need more information, please visit our website: www.avalue.com

2.1 ARC-1535 connector mapping

2.1.1 Serial port 1 connector (COM1)

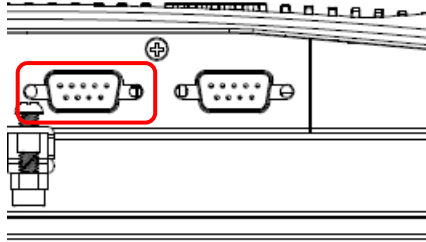

RS-485

Signal	PIN	PIN	Signal
DATA-	1	6	NC
DATA+	2	7	NC
NC	3	8	NC
NC	4	9	NC
GND	5		

Please set BIOS & JCOM1_SEL1

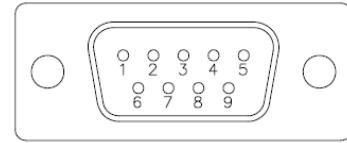

RS-232

Signal	PIN	PIN	Signal
NDCDA#	1	6	NDSRA#
NRXDA	2	7	NRTSA#
NTXDA	3	8	NCTSA#
NDTRA#	4	9	NRIA#
GND	5		

RS-422

Signal	PIN	PIN	Signal
TxD-	1	6	NC
TxD+	2	7	NC
RxD+	3	8	NC
RxD-	4	9	NC
GND	5		

Please set BIOS & JCOM1_SEL1

2.1.2 Serial port 2 connector (COM2)

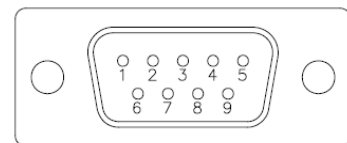
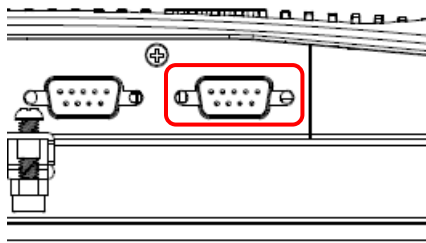

Signal	PIN	PIN	Signal
NDCDB#	1	6	NDSRB#
NRXDB	2	7	NRTSB#
NTXDB	3	8	NCTSB#
NDTRB#	4	9	NRIB#
GND	5		

2.2 Powering On the System

To power on the system, follow the steps below.

Step 1: Connect the power cord to the power adapter. Connect the other end of the power cord to a power source. Ensure to connect the power cord to a socket-outlet with earthing connection.

Step 2: Connect the power adapter to the power connector of the product.

Step 3: Locate the power button on the product.

Step 4: Switch on the power button can turn on the system. Keep holding the power button on can force shutdown the PC.

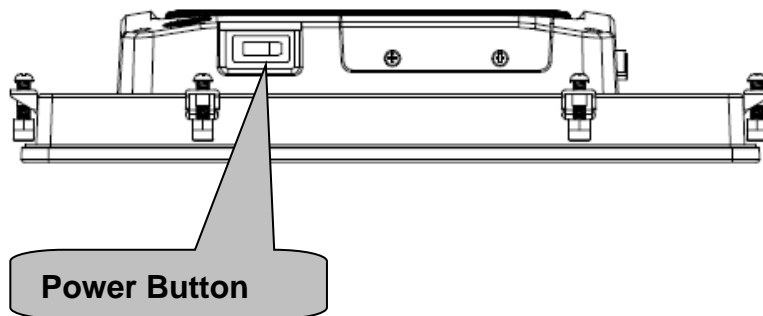
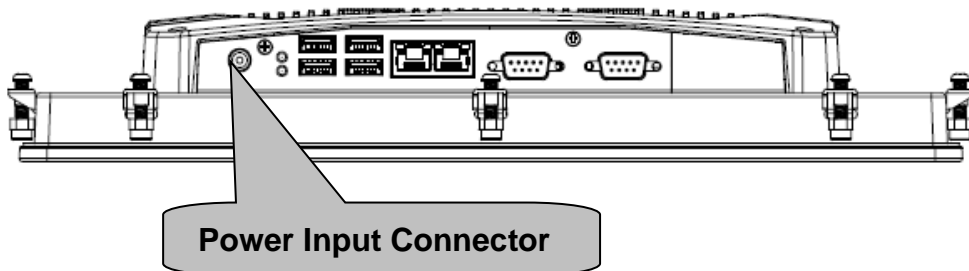

2.3 ARC-EHL Overviews

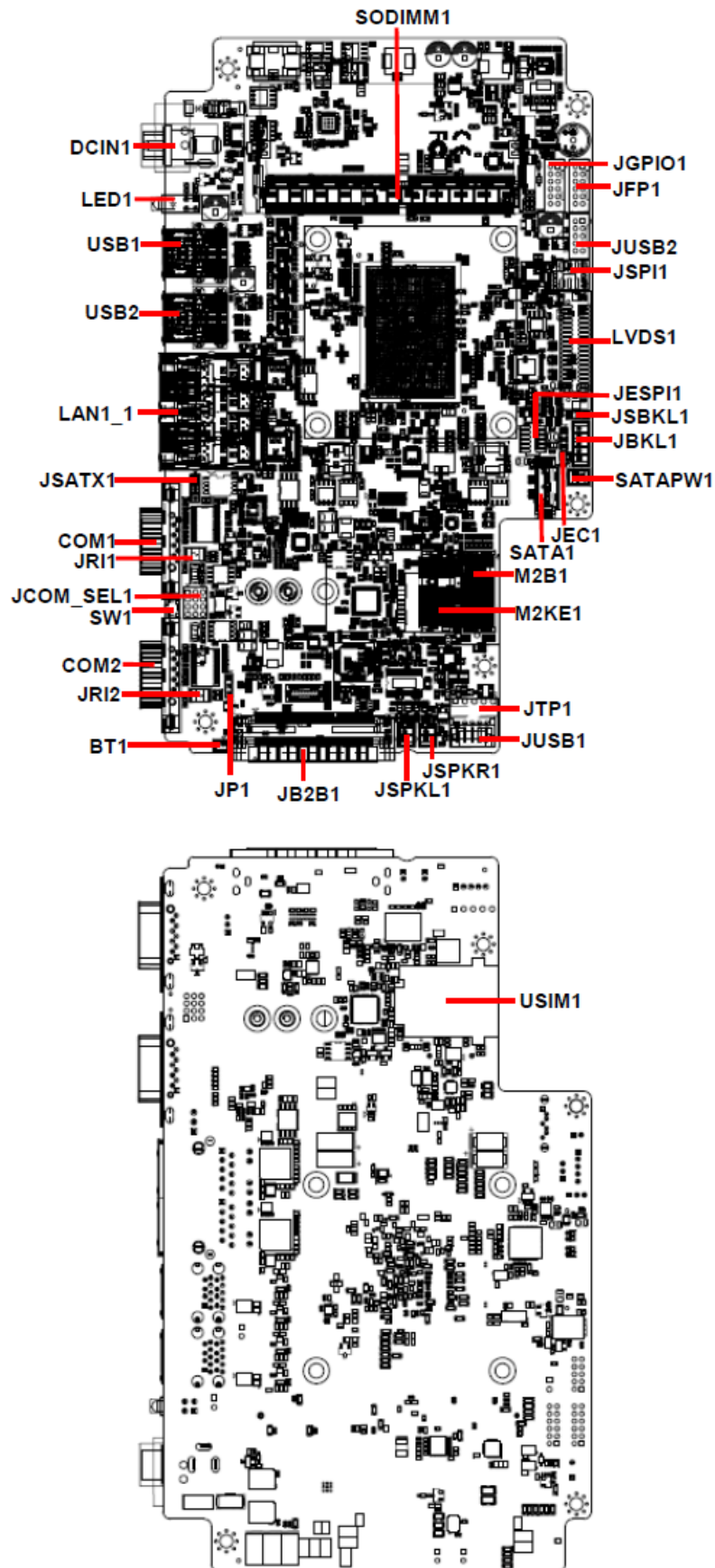

2.4 ARC-EHL Jumper and Connector list

Jumper

Label	Function	Note
JRI1/2	Serial port 1/2 pin9 signal select	3 x 2 header, pitch 2.00mm
JP1	M.2 KEY power select	3 x 1 header, pitch 2.00mm
JCOM_SEL1	Serial port 1 in RS-232/422/485 mode	4 x 3 header, pitch 2.00mm
JSBKL1	LCD backlight brightness adjustment	3 x 1 header, pitch 2.00mm
JSATX1	AT/ATX Input power select	3 x 1 header, pitch 2.54mm

Connectors

Label	Function	Note
SODIMM1	260-Pin DDR4 SO-DIMM	
JBKL1	LCD Inverter connector	5 x 1 wafer, pitch 2.00mm
COM1/2	Serial Port 1/2 connector	D-sub 9 pin, male
JSPKL1	AMPLIFIER_L	2 x 1 wafer, pitch 2.00mm
JSPKR1	AMPLIFIER_R	2 x 1 wafer, pitch 2.00mm
JB2B1	B2B connector	40 x 2 wafer, pitch 0.80mm
LED1	HDD/Power LED indicator	
LVDS1	LVDS connector	DIN 40-pin wafer, pitch 1.25mm
USB1/2	4 x USB3.2 connector	
JUSB1	On-board header for USB2.0	5 x 1 wafer, pitch 2.00mm
JUSB2	On-board header for USB2.0	5 x 2 wafer, pitch 2.00mm
LAN1_1	2 x RJ-45 Ethernet	
JFP1	Front Panel connector	6 x 2 wafer, pitch 2.00mm
BT1	Battery connector	2 x 1 wafer, pitch 1.25mm
JGPIO1	General purpose I/O connector	6 x 2 wafer, pitch 2.00mm
DCIN1	DC-IN connector	
JSPI1	SPI connector	4 x 2 header, pitch 2.00mm
SATA1	Serial ATA connector	
SATAPW1	SATA Power connector	2 x 1 wafer, pitch 2.00mm
SW1	Power button	
M2B1	M.2 KEY-B 2242/3042/3052 connector	
M2KE1	M.2 KEY-E 2230 connector	
JEC1	EC connector	3 x 1 header, pitch 2.00mm
JESPI1	ESPI connector	6 x 2 header, pitch 1.27mm

JTP1	Touch connector	5 x 1 header, pitch 2.54mm
USIM1	SIM card slot	

2.5 ARC-EHL Jumpers & Connectors settings

2.5.1 Serial port 1/2 pin9 signal select (JRI1/2)

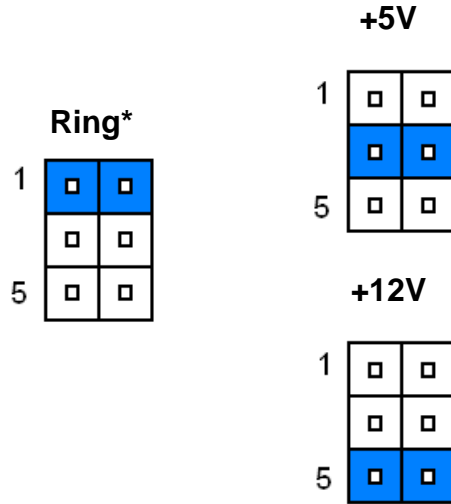
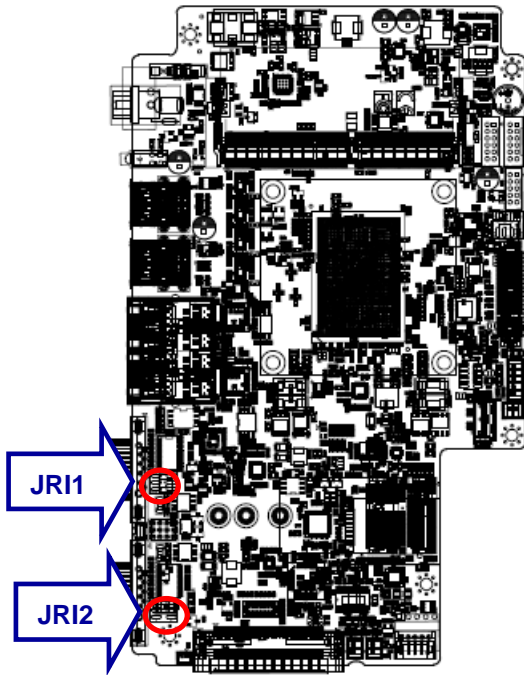

* Default

2.5.2 LCD backlight brightness adjustment (JSBKL1)

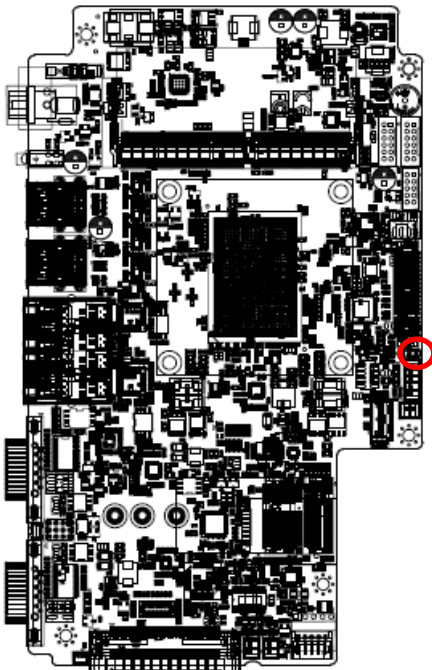

PWM Mode*



DC Mode

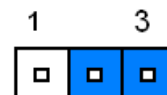

* Default

2.5.3 AT/ATX Input power select (JSATX1)

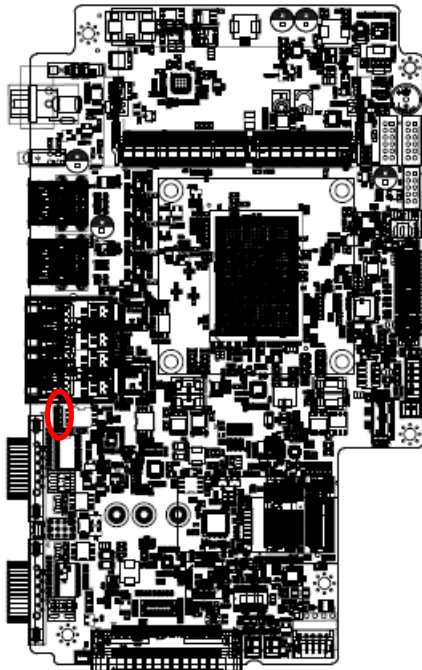

ATX*

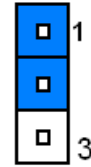

AT

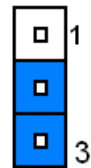

* Default

2.5.4 Serial port 1 in RS-232/422/485 mode (JCOM_SEL1)

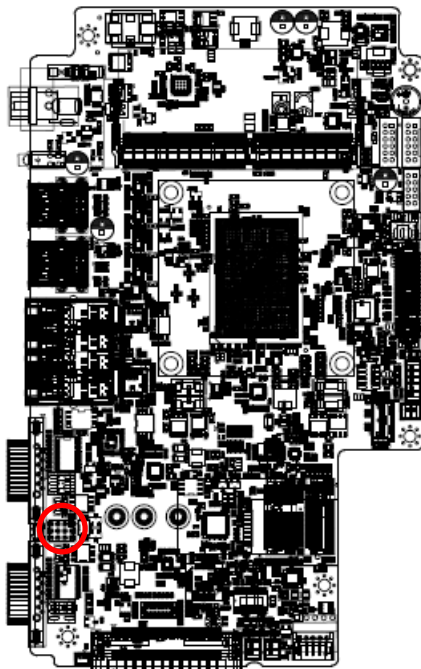

RS232*

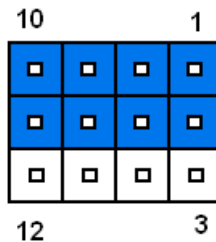

RS422

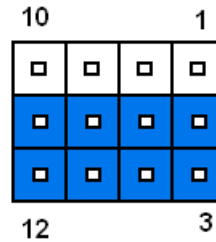

RS485

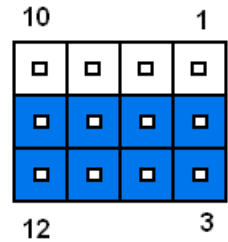

PIN	Signal	PIN	Signal	PIN	Signal
12	422RX1-	11	COM1-4	10	NDTRA#
9	485_422TX1+	8	COM1-2	7	NRXDA
6	422RX1+	5	COM1-3	4	NTXDA
3	485_422TX1-	2	COM1-1	1	NDCDA#

* Default

Note:

This connector is available after modify the mode of COM1 in BIOS setting.

ARC-1535

2.5.5 M.2 KEY power select (JP1)

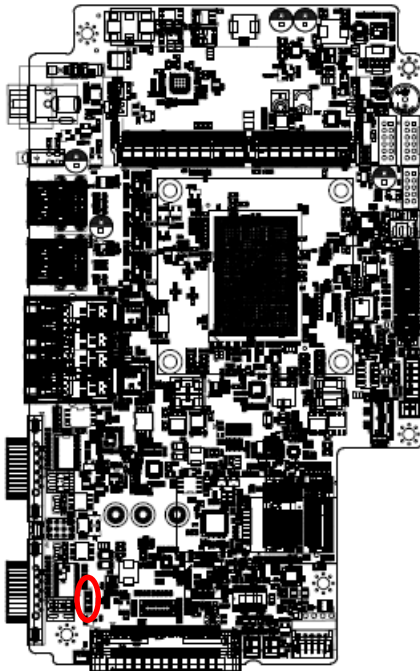

+3.8V

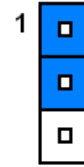

+3.3V*

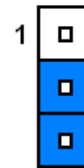

*Default

2.5.6 LCD Inverter connector (JBKL1)

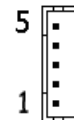
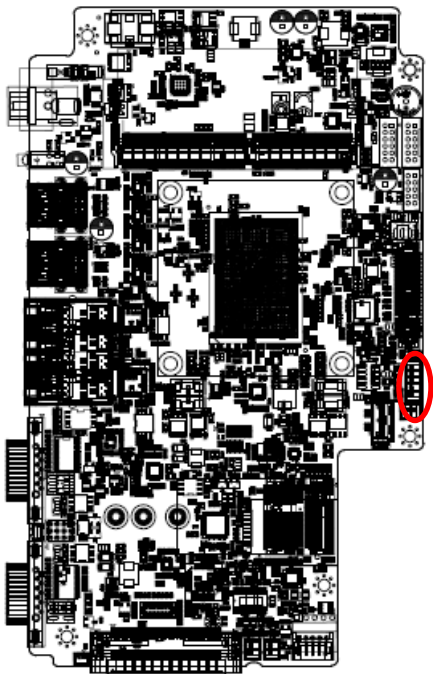

Signal	PIN
+5V	5
LVDS_BKLTCTL	4
LVDS_BKLT_EN	3
GND	2
+12V	1

2.5.7 Touch connector (JTP1) co-lay USB2.0 header (JUSB1)

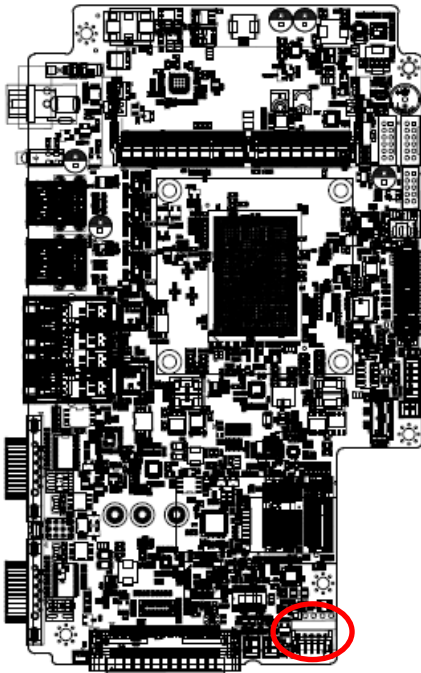

*Default

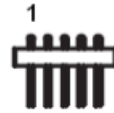

JTP1*

Signal	PIN
X+	1
X-	2
SENSE	3
Y+	4
Y-	5

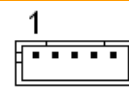

JUSB1

Signal	PIN
+5VSB	1
USB_WFR_PN8	2
USB_WFR_PP8	3
GND	4
GND	5

2.5.8 On-board header for USB2.0 (JUSB2)

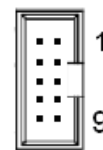
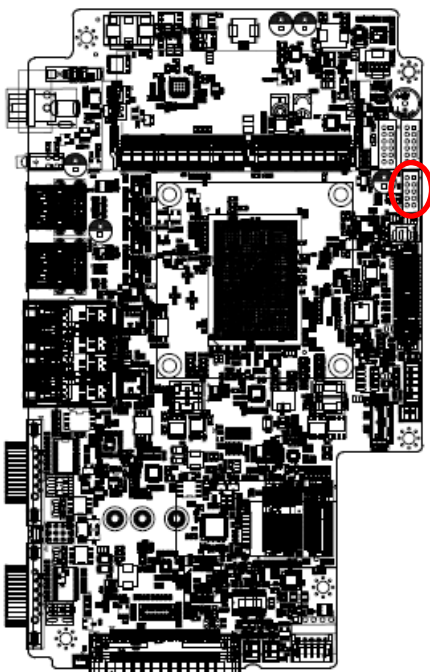

Signal	PIN	PIN	Signal
+5VSB	2	1	+5VSB
USB2_R_DN6	4	3	USB2_R_DN5
USB2_R_DP6	6	5	USB2_R_DP5
GND	8	7	GND
GND	10	9	GND

2.5.9 LVDS connector (LVDS1)

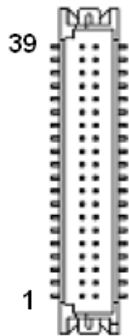
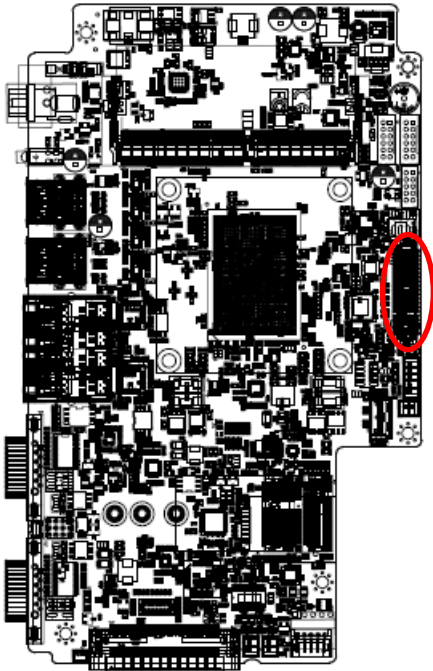

Signal	PIN	PIN	Signal
+12V	39	40	+12V
GND	37	38	LVDS_GND/EDP_HPDP
LVDS_CLK2_N	35	36	LVDS_CLK1_N
LVDS_CLK2_P	33	34	LVDS_CLK1_P
GND	31	32	GND
LVDS_DATA7_N	29	30	LVDS_DATA6_N
LVDS_DATA7_P	27	28	LVDS_DATA6_P
GND	25	26	GND
LVDS_DATA5_N/ EDP_TXN2	23	24	LVDS_DATA4_N
LVDS_DATA5_P/ EDP_TXP2	21	22	LVDS_DATA4_P
GND	19	20	GND
LVDS_DATA3_N/ EDP_TXN1	17	18	LVDS_DATA2_N/ EDP_AUXN
LVDS_DATA3_P/ EDP_TXP1	15	16	LVDS_DATA2_P/ EDP_AUXP
GND	13	14	GND
LVDS_DATA1_N/ EDP_TXN0	11	12	LVDS_DATA0_N/ EDP_TXN3
LVDS_DATA1_P/ EDP_TXP0	9	10	LVDS_DATA0_P/ EDP_TXP3
GND	7	8	GND
LVDS_DDC_CLK_R	5	6	LVDS_DDC_DATA_R
VCC_LVDS/EDP	3	4	+5V
VCC_LVDS/EDP	1	2	+5V

* Pin1 & 3 -- VCC_LVDS/EDP default 3.3V, BOM option 5/12V.

2.5.10 AMPLIFIER_R (JSPKR1)

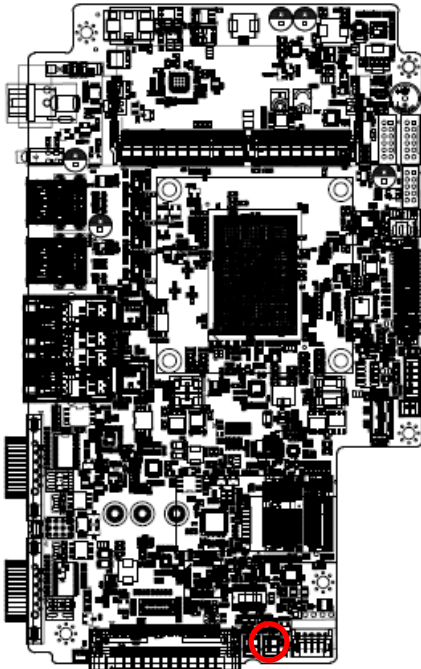

Signal	PIN
SPK_R-	2
SPK_R+	1

2.5.11 AMPLIFIER_L (JSPKL1)

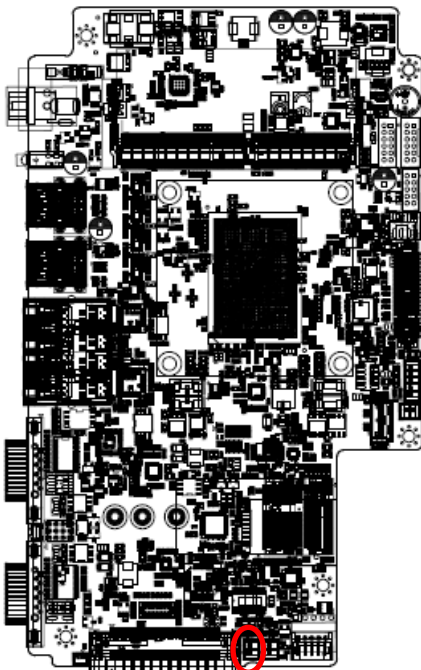

Signal	PIN
SPK_L-	2
SPK_L+	1

2.5.12 Battery connector (BT1)

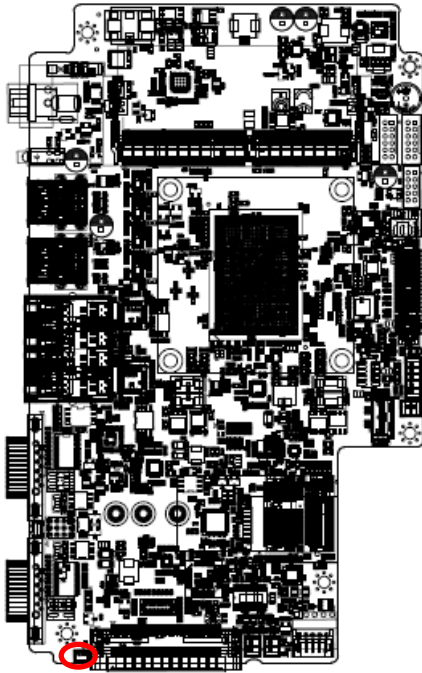

Signal	PIN
+RTCBATT	1
GND	2

2.5.13 SPI connector (JSPI1)

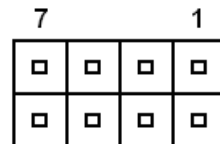
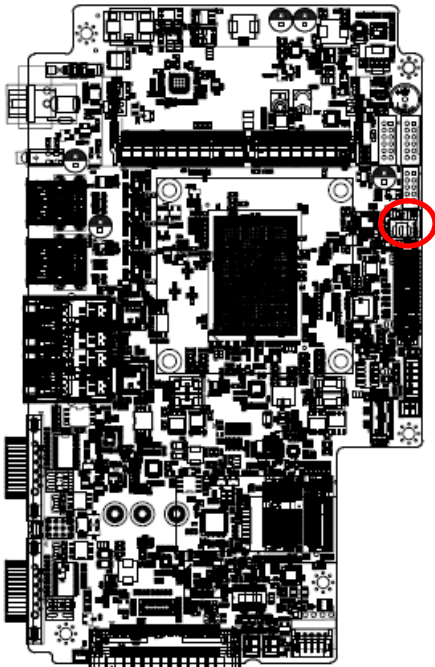

Signal	PIN	PIN	Signal
+3.3VSB	1	2	GND
ROM_CS#	3	4	ROM_SPI_CLK
ROM_SPI_MISO	5	6	ROM_SPI_MOSI
HOLD#	7	8	SPI_WP#

2.5.14 B2B connector (JB2B1)

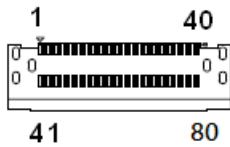
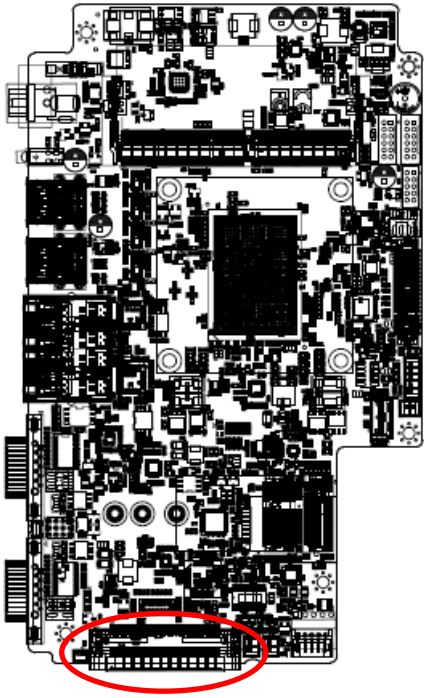

Signal	PIN	PIN	Signal
GND	1	41	GND
GND	2	42	GND
+12V	3	43	GND
+12V	4	44	GND
GND	5	45	GND
LPC_SERIRQ	6	46	+5VSB
LPC_LFRAME#	7	47	+5VSB
CLK_24M_B2B	8	48	+5VSB
LPC_AD0	9	49	+5VSB
LPC_AD1	10	50	+5VSB

Signal	PIN	PIN	Signal
LPC_AD2	11	51	GND
LPC_AD3	12	52	B2B_USB2_DP7
PS_ON_B2B	13	53	B2B_USB2_DN7
PLT_BUF_RST#	14	54	GND
PCH_SLP_S3#	15	55	SMB_SCL_S0
HDMI1_HPD_CONN	16	56	SMB_SDA_S0
GND	17	57	GND
HDMI1_DDC_CLK	18	58	B2B_BOARD_ID
HDMI1_DDC_DAT	19	59	PCIEUSB3_PONRSTB
GND	20	60	PCIEUSB3_SMIB_INT#
HDMI1_TX_N2	21	61	B2BPCIE_WAKE#
HDMI1_TX_P2	22	62	RST_B2BPCIE#
GND	23	63	CLK_B2B_REQ2#
HDMI1_TX_N1	24	64	GND
HDMI1_TX_P1	25	65	PCIE_TXN8
GND	26	66	PCIE_TXP8
HDMI1_TX_N0	27	67	GND
HDMI1_TX_P0	28	68	PCIE_RXN8
GND	29	69	PCIE_RXP8
HDMI1_CLKN	30	70	GND
HDMI1_CLKP	31	71	CLK_B2B_N2
GND	32	72	CLK_B2B_P2
GND	33	73	GND
MICIN_R	34	74	GND
MICIN_L	35	75	MIC1_JD
GND	36	76	GND
LINEOUT1_JD	37	77	LINE1-JD
LINEOUT_R	38	78	LINEIN_R
LINEOUT_L	39	79	LINEIN_L
GND	40	80	GND

2.5.15 General purpose I/O connector (JGPIO1)

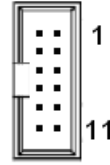
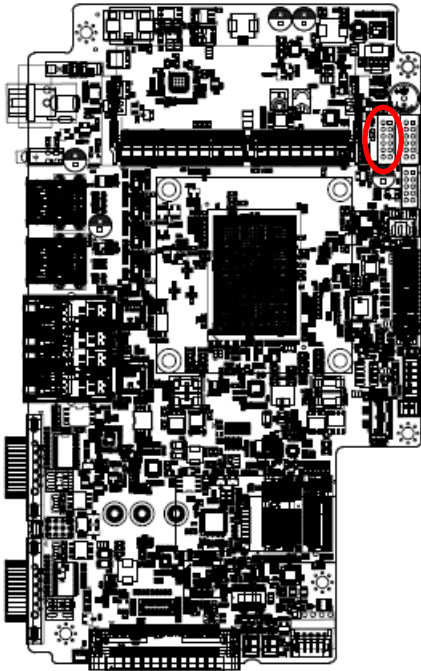

Signal	PIN	PIN	Signal
DO0	2	1	DI0
DO1	4	3	DI1
DO2	6	5	DI2
DO3	8	7	DI3
SMB_SCL_S0	10	9	SMB_SDA_S0
GND	12	11	+3.3V

2.5.16 SATA Power connector (SATAPW1)

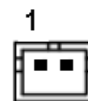
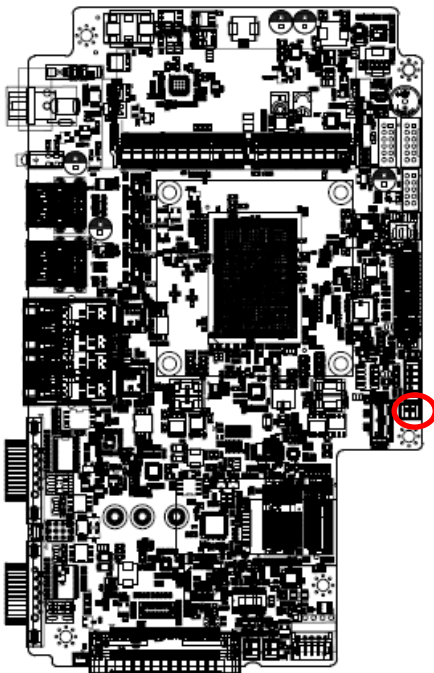

Signal	PIN
GND	1
+5V	2

2.5.17 Front Panel connector (JFP1)

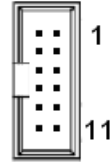
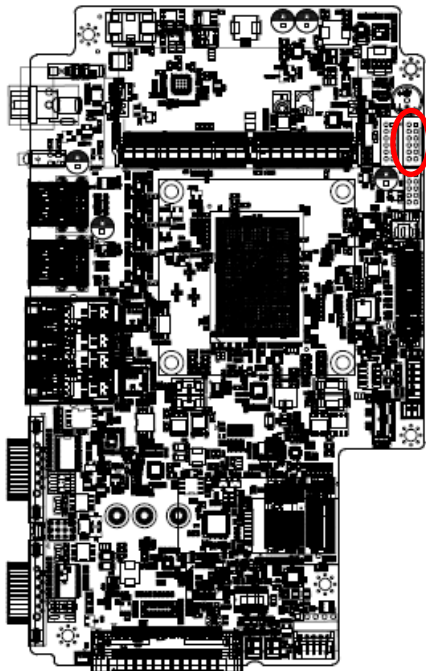

Signal	PIN
PWBT	1
	2
RST#	3
	4
PWR-LED-	5
PWR-LED+	6
HDD-LED-	7
HDD-LED+	8
LAN1-LED-	9
LAN1-LED+	10
LAN2-LED-	11
LAN2-LED+	12

2.5.18 ESPI connector (JESPI1)

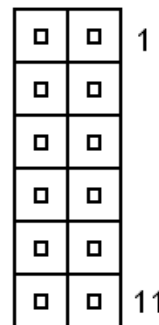
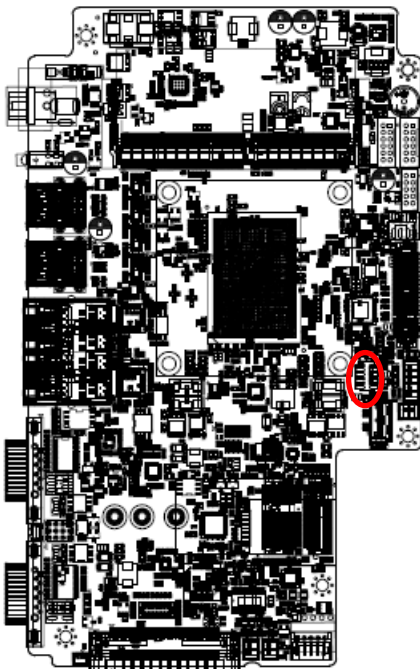

Signal	PIN	PIN	Signal
+3.3VSB	2	1	CN_ESPI_IO0
PLT_BUF_RST#	4	3	CN_ESPI_IO1
ESPI_CS#0	6	5	CN_ESPI_IO2
CN_ESPI_CLK	8	7	CN_ESPI_IO3
GND	10	9	NC
ESPI_ALERT#2	12	11	ESPI_RST#

2.5.19 EC connector (JEC1)

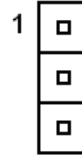
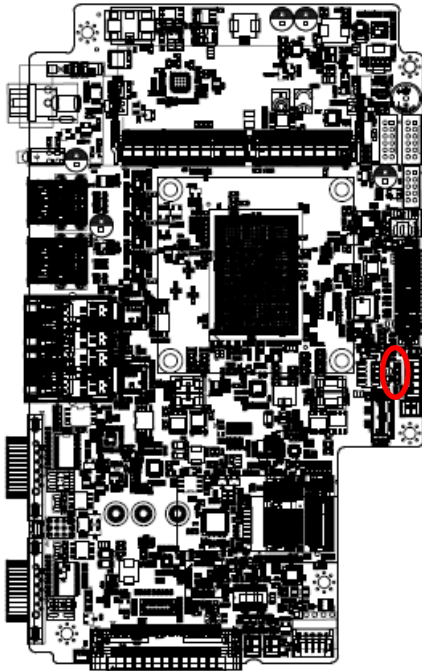

Signal	PIN
EC_SMDAT_DBG	1
EC_SMCLK_DBG	2
GND	3

2.6 ARC-BYT DB-A/B/C/D/G/H/K Overviews

2.6.1 ARC-BYT DB-A

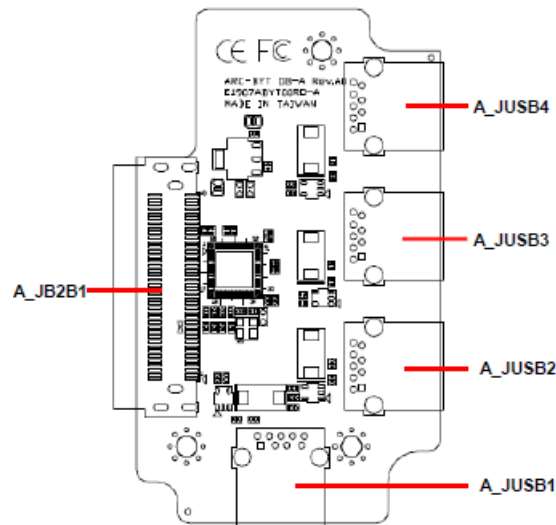

2.6.2 ARC-BYT DB-B

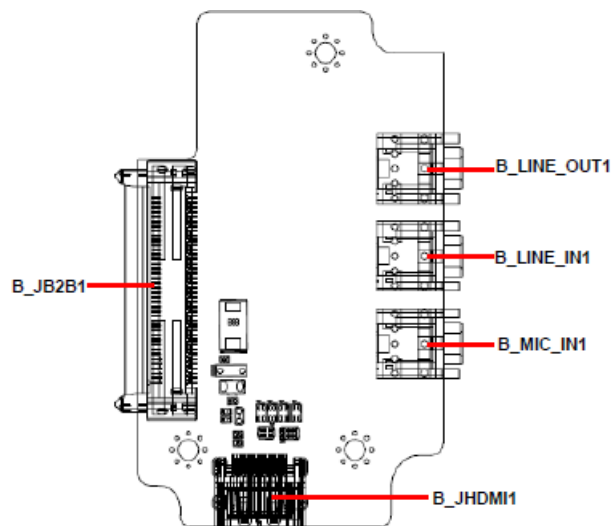

2.6.3 ARC-BYT DB-C

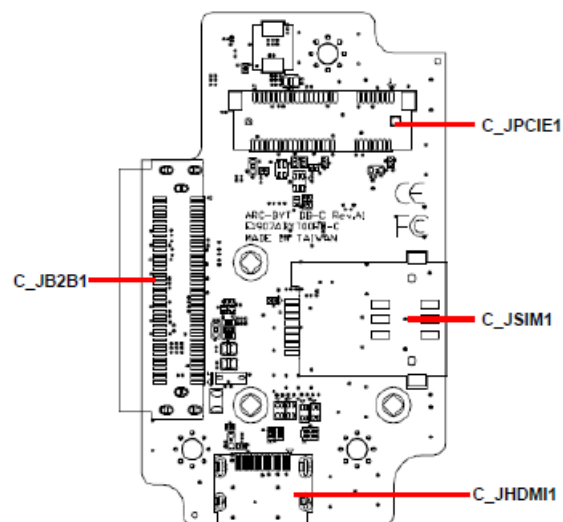

ARC-1535

2.6.4 ARC-BYT DB-D

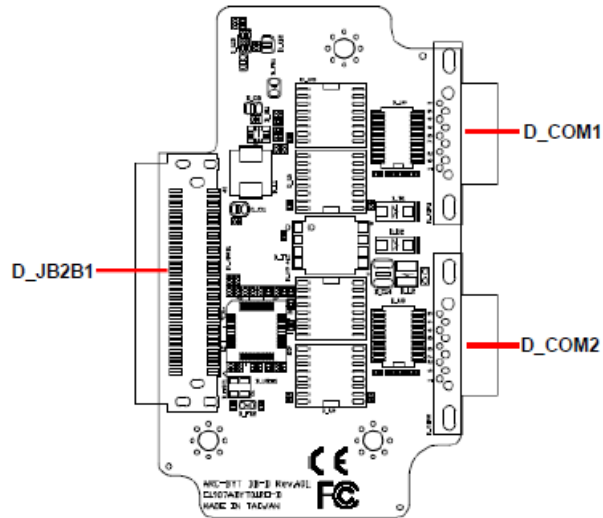

2.6.5 ARC-BYT DB-G

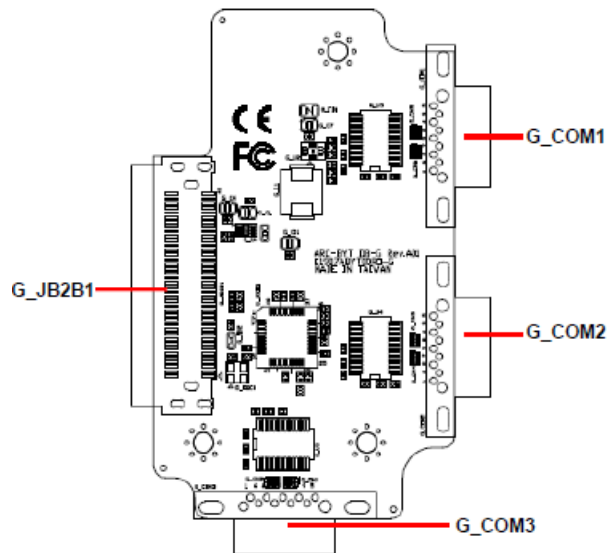

2.6.6 ARC-BYT DB-H

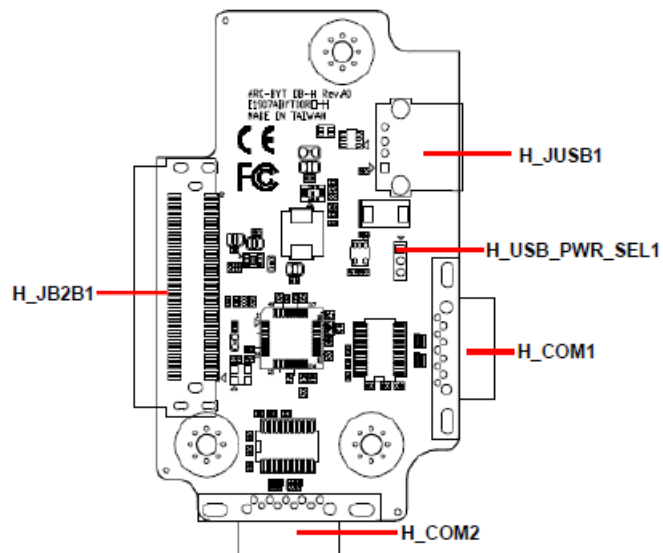

2.6.7 ARC-BYT DB-K

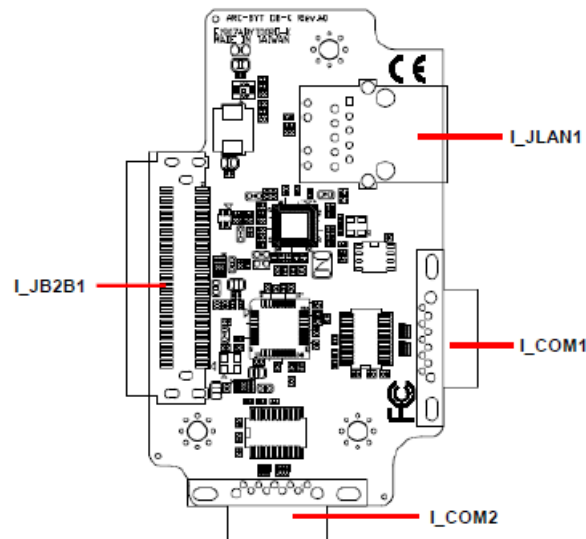

2.7 ARC-BYT DB-A/B/C/D/G/H/K Connector list

2.7.1 ARC-BYT DB-A

Connectors

Label	Function	Note
A_JUSB1~4	USB3.0 connector 1~4	
A_JB2B1	B2B connector	

2.7.2 ARC-BYT DB-B

Connectors

Label	Function	Note
B_LINE_OUT1	Line-out audio jack	
B_LINE_IN1	Line-in audio jack	
B_MIC_IN1	Mic-in audio jack	
B_JHDMI1	HDMI connector	
B_JB2B1	B2B connector	

2.7.3 ARC-BYT DB-C

Connectors

Label	Function	Note
C_JPCIE1	Mini PCI Express connector	
C_JSIM1	SIM card slot (Push-push)	
C_JHDMI1	HDMI connector	
C_JB2B1	B2B connector	

2.7.4 ARC-BYT DB-D

Connectors

Label	Function	Note
D_COM1/2	Serial Port 1/2 connector	DB-9 male connector
D_JB2B1	B2B connector	

2.7.5 ARC-BYT DB-G

Connectors

Label	Function	Note
G_COM1/2/3	Serial Port 1/2/3 connector	DB-9 male connector
G_JB2B1	B2B connector	

2.7.6 ARC-BYT DB-H

Jumpers

Label	Function	Note
H_USB_PWR_SEL1	USB Power selector	3 x 1 header, pitch 2.00mm

Connectors

Label	Function	Note
H_JUSB1	USB3.0 connector	
H_COM1/2	Serial Port 1/2 connector	DB-9 male connector
H_JB2B1	B2B connector	

2.7.7 ARC-BYT DB-K

Connectors

Label	Function	Note
I_JLAN1	RJ-45 Ethernet	
I_COM1/2	Serial Port 1/2 connector	DB-9 male connector
I_JB2B1	B2B connector	

2.8 ARC-BYT DB-D Connectors settings

2.8.1 Serial Port 1 connector (D_COM1)

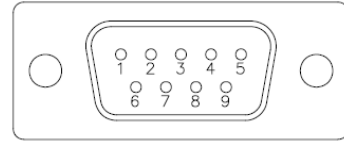
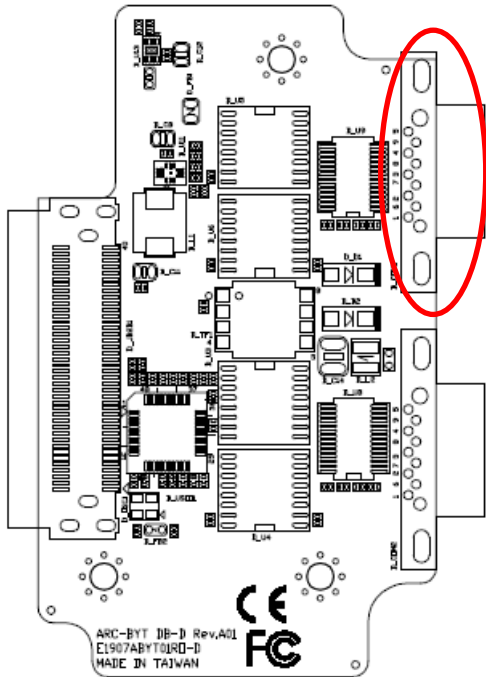

Signal	PIN	PIN	Signal
NDCD#_3_D	1	6	NDSR#_3_D
NRXD_3_D	2	7	NRTS#_3_D
NTXD_3_D	3	8	NCTS#_3_D
NDTR#_3_D	4	9	NRI#_3_D
GND	5		

2.8.2 Serial Port 2 connector (D_COM2)

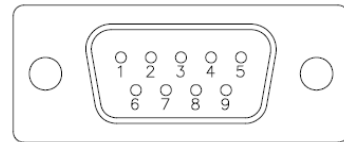
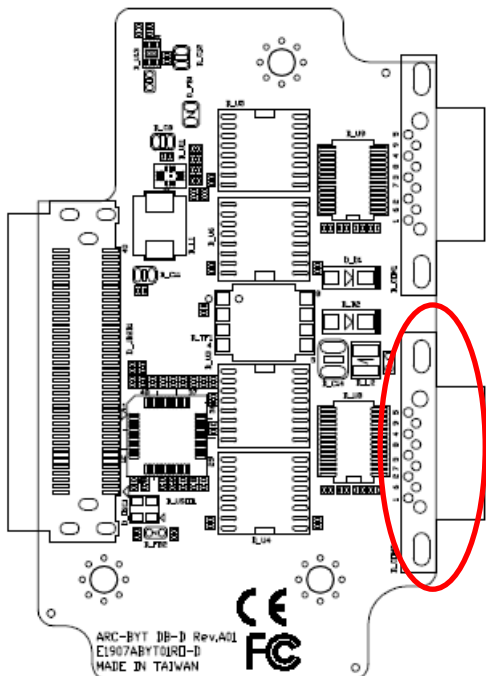

Signal	PIN	PIN	Signal
NDCD#_2_D	1	6	NDSR#_2_D
NRXD_2_D	2	7	NRTS#_2_D
NTXD_2_D	3	8	NCTS#_2_D
NDTR#_2_D	4	9	NRI#_2_D
GND	5		

2.9 ARC-BYT DB-G Connectors settings

2.9.1 Serial Port 1 connector (G_COM1)

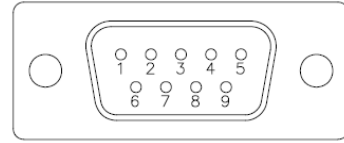
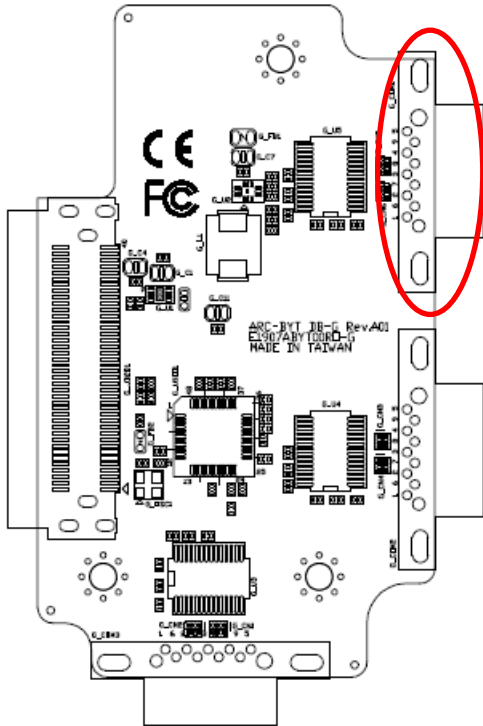

Signal	PIN	PIN	Signal
NDCD#_3_G	1	6	NDSR#_3_G
NRXD_3_G	2	7	NRTS#_3_G
NTXD_3_G	3	8	NCTS#_3_G
NDTR#_3_G	4	9	NRI#_3_G
GND	5		

2.9.2 Serial Port 2 connector (G_COM2)

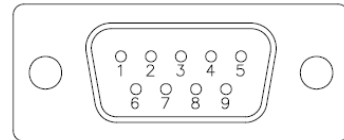
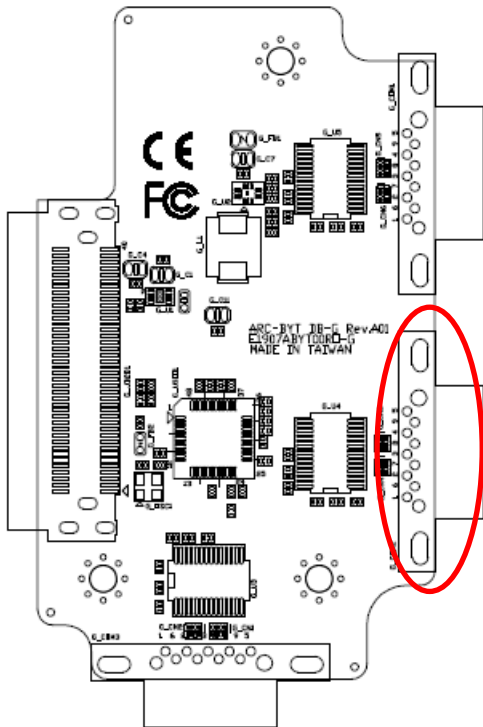

Signal	PIN	PIN	Signal
NDCD#_2_G	1	6	NDSR#_2_G
NRXD_2_G	2	7	NRTS#_2_G
NTXD_2_G	3	8	NCTS#_2_G
NDTR#_2_G	4	9	NRI#_2_G
GND	5		

2.9.3 Serial Port 3 connector (G_COM3)

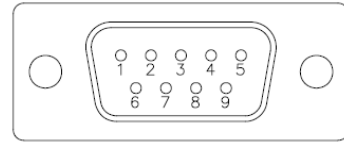
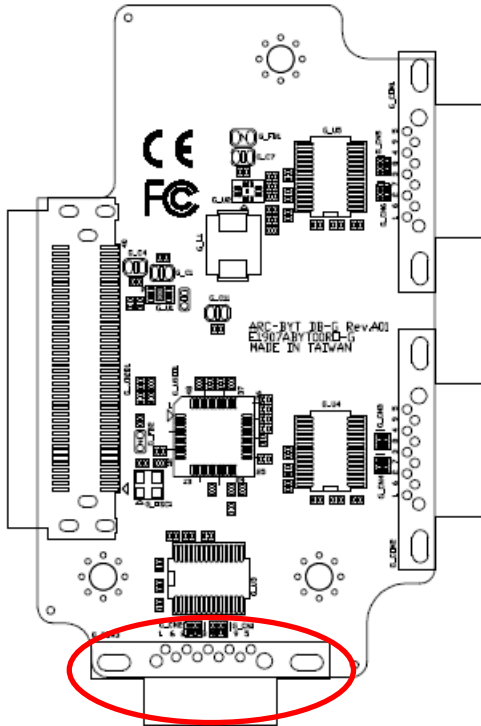

Signal	PIN	PIN	Signal
NDCD#_1_G	1	6	NDSR#_1_G
NRXD_1_G	2	7	NRTS#_1_G
NTXD_1_G	3	8	NCTS#_1_G
NDTR#_1_G	4	9	NRI#_1_G
GND	5		

2.10 ARC-BYT DB-H Jumpers settings

2.10.1 USB Power selector (H_USB_PWR_SEL1)

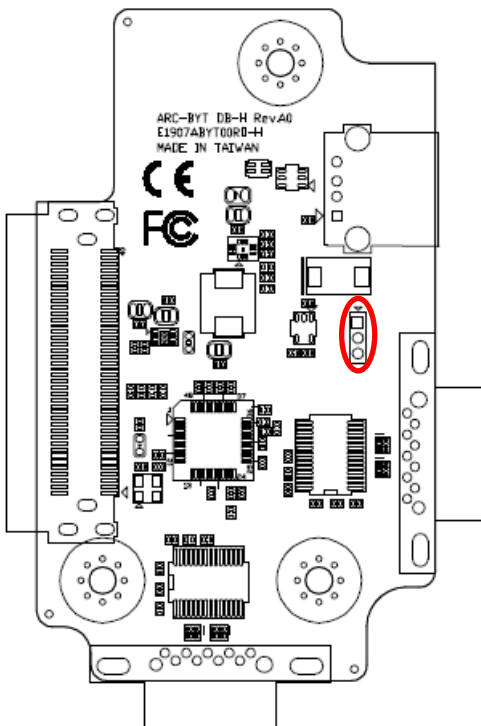

+5VSB*

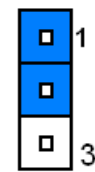

+5V

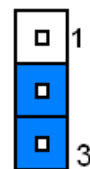

*Default

2.11 ARC-BYT DB-H Connectors settings

2.11.1 Serial Port 1 connector (H_COM1)

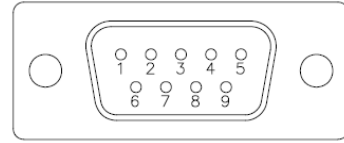
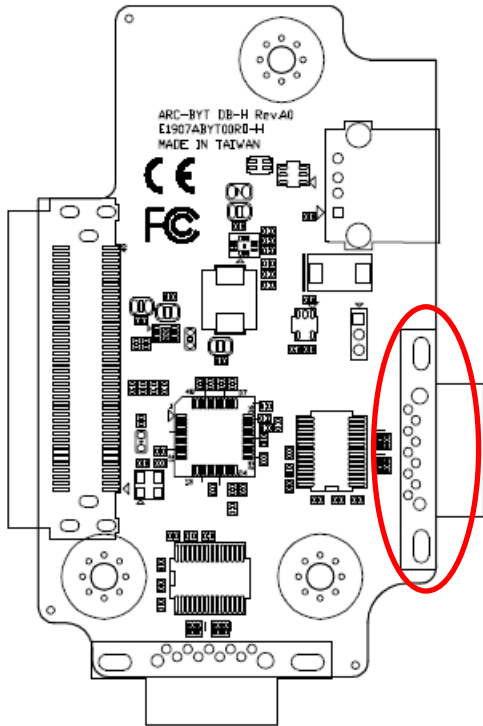

Signal	PIN	PIN	Signal
NDCD#_1_H	1	6	NDSR#_1_H
NRXD_1_H	2	7	NRTS#_1_H
NTXD_1_H	3	8	NCTS#_1_H
NDTR#_1_H	4	9	NRI#_1_H
GND	5		

2.11.2 Serial Port 2 connector (H_COM2)

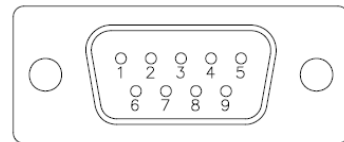
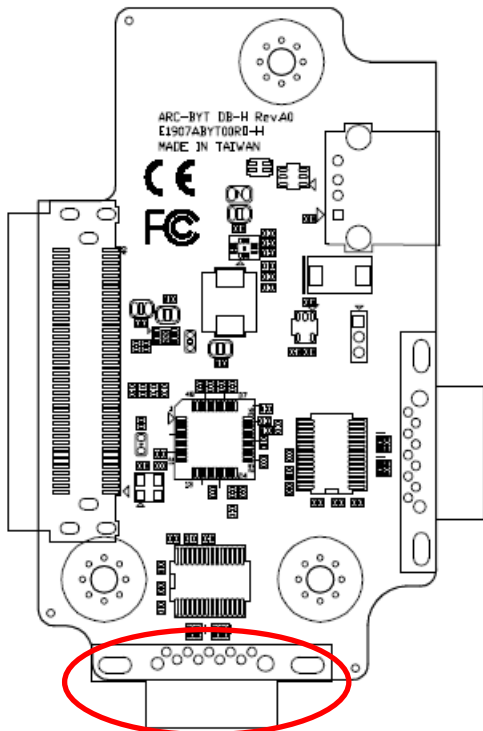

Signal	PIN	PIN	Signal
NDCD#_2_H	1	6	NDSR#_2_H
NRXD_2_H	2	7	NRTS#_2_H
NTXD_2_H	3	8	NCTS#_2_H
NDTR#_2_H	4	9	NRI#_2_H
GND	5		

2.12 ARC-BYT DB-K Connectors settings

2.12.1 Serial Port 1 connector (I_COM1)

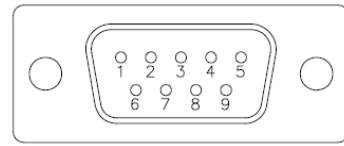
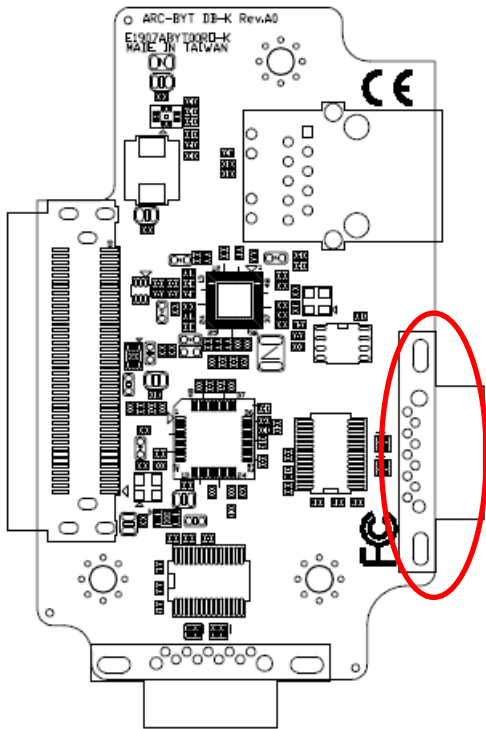

Signal	PIN	PIN	Signal
NDCD#_1_I	1	6	NDSR#_1_I
NRXD_1_I	2	7	NRTS#_1_I
NTXD_1_I	3	8	NCTS#_1_I
NDTR#_1_I	4	9	NRI#_1_I
GND	5		

2.12.2 Serial Port 2 connector (I_COM2)

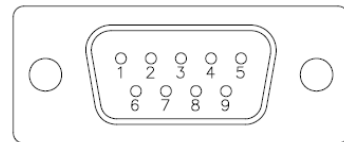
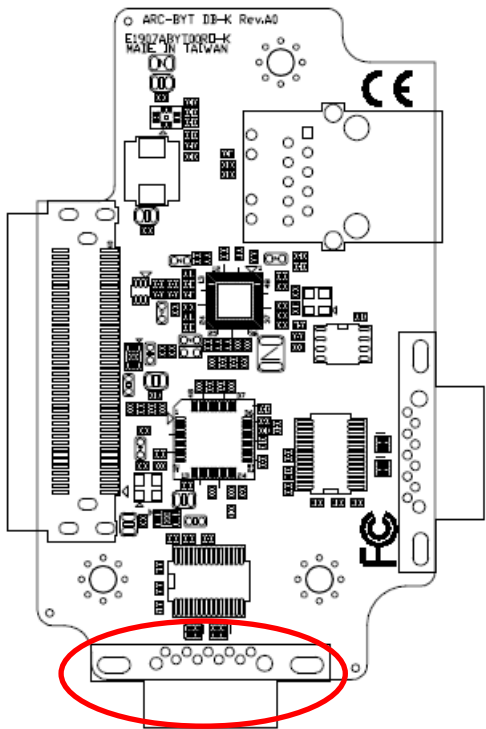

Signal	PIN	PIN	Signal
NDCD#_2_I	1	6	NDSR#_2_I
NRXD_2_I	2	7	NRTS#_2_I
NTXD_2_I	3	8	NCTS#_2_I
NDTR#_2_I	4	9	NRI#_2_I
GND	5		

3. Installation



Removing the Top Cover Warning

To prevent electric shock or system damage, before removing the chassis cover, must turn off power and disconnect the unit from power source.

Electrostatic discharge (ESD) can cause serious damage to electronic components. Dry climates are especially susceptible to ESD. It is therefore critical that whenever the product is accessed internally, or any other electrical component is handled, the following anti-static precautions are strictly adhered to:

- Wear an anti-static wristband: Wearing a simple anti-static wristband can help to prevent ESD from damaging the board.
- Self-grounding: Before handling the board, touch any grounded conducting material. During the time the board is handled, frequently touch any conducting materials that are connected to the ground.
- Use an anti-static pad: When configuring the product, place it on an anti-static pad. This reduces the possibility of ESD damaging the product.
- Only handle the edges of the PCB: When handling the PCB, hold the PCB by the edges.

Installation Precautions

When installing the flat bezel panel PC, please follow the precautions listed below:

- Power turned off: When installing the flat bezel panel PC, make sure the power is off. Failing to turn off the power may cause severe injury to the body and/or damage to the system.
- Certified Engineers: Never open the equipment. For safety reasons, the equipment should be opened only by qualified skilled person.
- Anti-static Discharge: If a user open the rear panel of the flat bezel panel PC, to configure the jumpers or plug in added peripheral devices, ground themselves first and wear an anti-static wristband.

3.1 Installing Memory

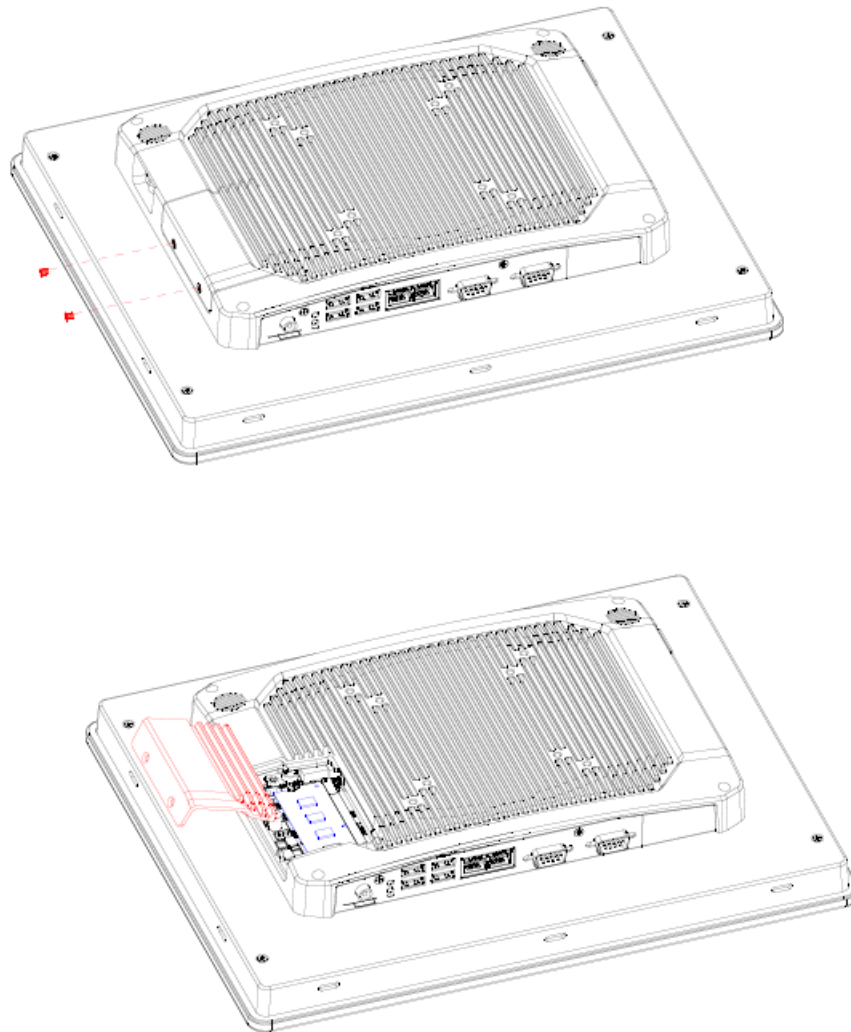

Step 1. Remove 2 screws to release the chassis cover, and remove it.

Step 2. Slide the DDR4 SODIMM into the memory socket and press it down until properly seated.

4. BIOS Setup

4.1 Introduction

The BIOS setup program allows users to modify the basic system configuration. In this following chapter will describe how to access the BIOS setup program and the configuration options that may be changed.

4.2 Starting Setup

AMI BIOS™ is immediately activated when you first power on the computer. The BIOS reads the system information contained in the NVRAM and begins the process of checking out the system and configuring it. When it finishes, the BIOS will seek an operating system on one of the disks and then launch and turn control over to the operating system.

While the BIOS is in control, the Setup program can be activated in one of two ways:

By pressing <F2> or immediately after switching the system on, or

By pressing the <F2> or key when the following message appears briefly at the left-top of the screen during the POST (Power On Self Test).

Press <F2> or to enter SETUP

If the message disappears before you respond and you still wish to enter Setup, restart the system to try again by turning it OFF then ON or pressing the "RESET" button on the system case. You may also restart by simultaneously pressing <Ctrl>, <Alt>, and <Delete> keys.

4.3 Using Setup

In general, you use the arrow keys to highlight items, press <Enter> to select, use the PageUp and PageDown keys to change entries, press <F1> for help and press <Esc> to quit. The following table provides more detail about how to navigate in the Setup program using the keyboard.

Button	Description
↑	Move to previous item
↓	Move to next item
←	Move to the item in the left hand
→	Move to the item in the right hand
Esc key	Main Menu -- Quit and not save changes into NVRAM Status Page Setup Menu and Option Page Setup Menu -- Exit current page and return to Main Menu
+ key	Increase the numeric value or make changes
- key	Decrease the numeric value or make changes
F1 key	General help, only for Status Page Setup Menu and Option Page Setup Menu
F2 key	Previous Values
F3 key	Optimized defaults
F4 key	Save & Exit Setup

- **Navigating Through The Menu Bar**

Use the left and right arrow keys to choose the menu you want to be in.



Note: Some of the navigation keys differ from one screen to another.

- **To Display a Sub Menu**

Use the arrow keys to move the cursor to the sub menu you want. Then press <Enter>. A “>” pointer marks all sub menus.

4.4 Getting Help

Press F1 to pop up a small help window that describes the appropriate keys to use and the possible selections for the highlighted item. To exit the Help Window press <Esc> or the F1 key again.

4.5 In Case of Problems

If, after making and saving system changes with Setup, you discover that your computer no longer is able to boot, the AMI BIOS supports an override to the NVRAM settings which resets your system to its defaults.

The best advice is to only alter settings which you thoroughly understand. To this end, we strongly recommend that you avoid making any changes to the chipset defaults. These defaults have been carefully chosen by both BIOS Vendor and your systems manufacturer to provide the absolute maximum performance and reliability. Even a seemingly small change to the chipset setup has the potential for causing you to use the override.

4.6 BIOS setup

Once you enter the Aptio Setup Utility, the Main Menu will appear on the screen. The Main Menu allows you to select from several setup functions and exit choices. Use the arrow keys to select among the items and press <Enter> to accept and enter the sub-menu.

4.6.1 Main Menu

This section allows you to record some basic hardware configurations in your computer and set the system clock.

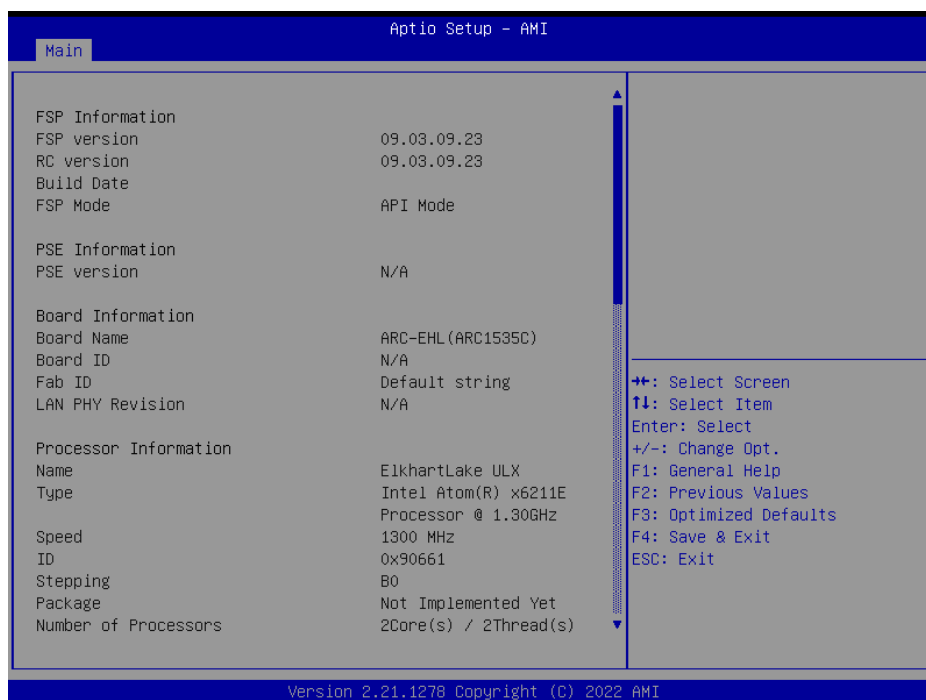
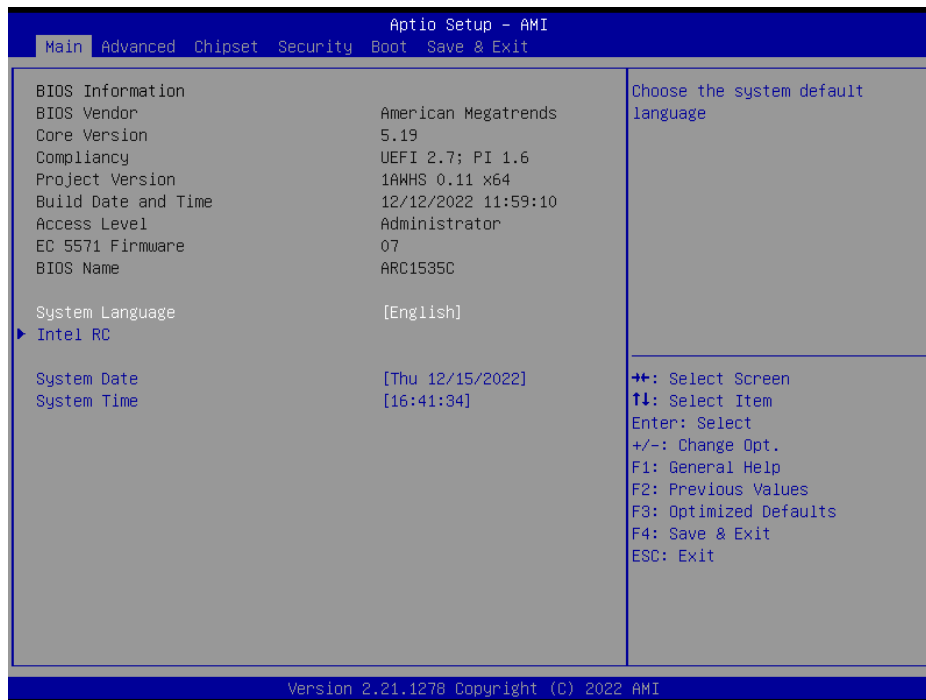

4.6.1.1 System Language

This option allows choosing the system default language.

4.6.1.2 System Date

Use the system date option to set the system date. Manually enter the month, day and year.

4.6.1.3 System Time

Use the system time option to set the system time. Manually enter the hours, minutes and seconds.



Note: The BIOS setup screens shown in this chapter are for reference purposes only, and may not exactly match what you see on your screen. Visit the Avalue website (www.avalu.com) to download the latest product and BIOS information.

4.6.2 Advanced Menu

This section allows you to configure your CPU and other system devices for basic operation through the following sub-menus.

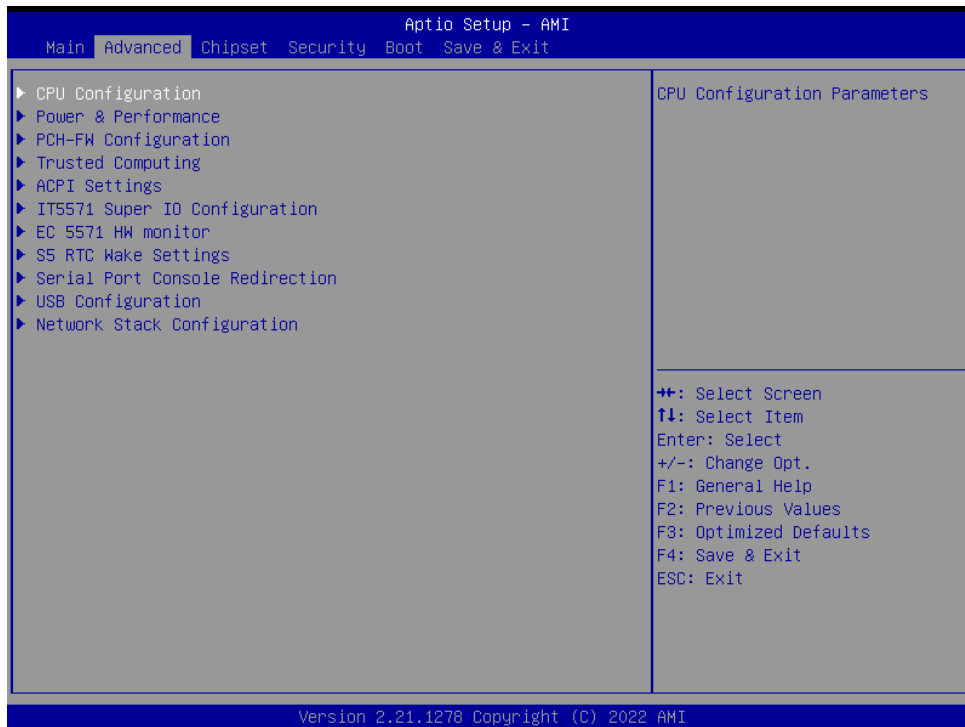

4.6.2.1 CPU Configuration

Use the CPU configuration menu to view detailed CPU specification and configure the CPU.

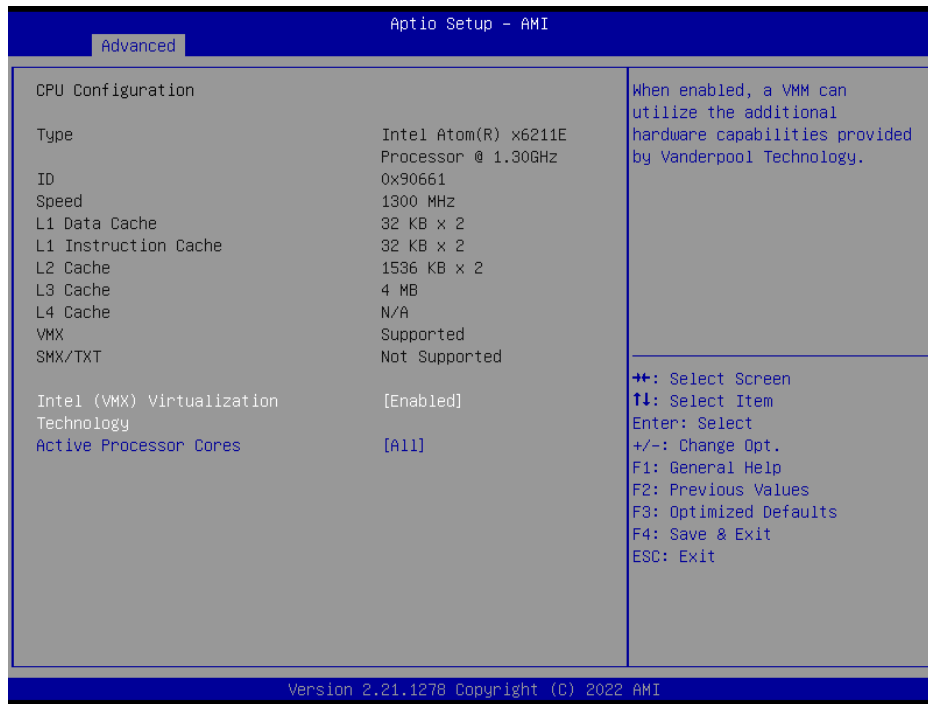

Item	Options	Description
Intel (VMX) Virtualization Technology	Disabled Enabled[Default]	When enabled, a VMM can utilize the additional hardware capabilities provided by Vanderpool Technology.
Active Processor Cores	All[Default] 1	Number of cores to enable in each processor package.

4.6.2.2 Power & Performance

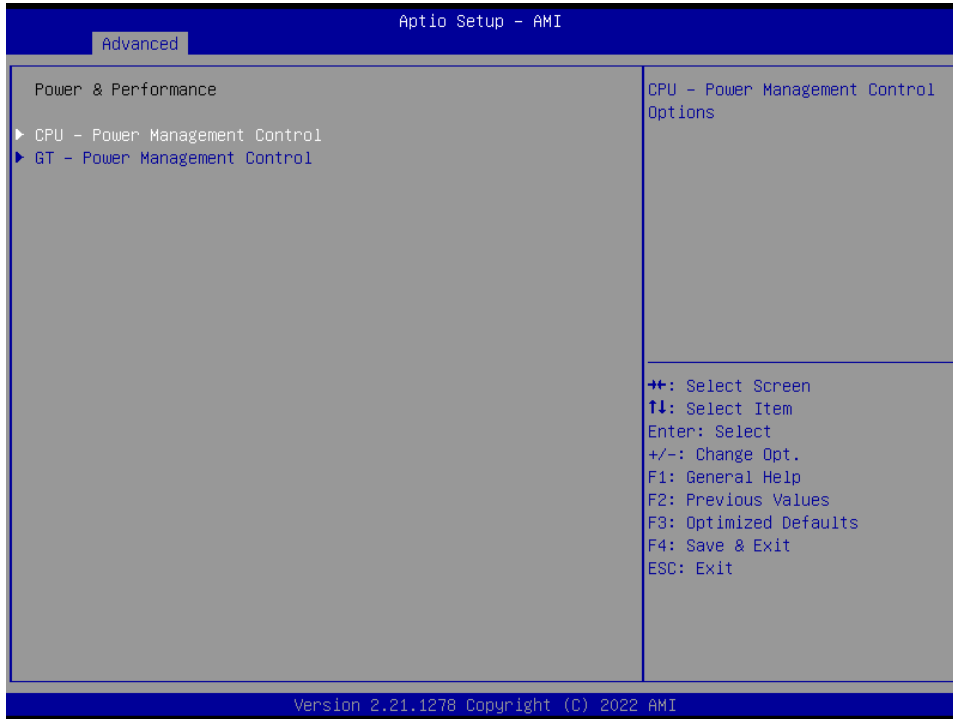

4.6.2.2.1 CPU – Power Management Control



Item	Option	Description
Boot performance mode	Max Non-Turbo Performance[Default], Turbo Performance	Select the performance state that the BIOS will set starting from reset vector.
Intel® SpeedStep™	Enabled[Default], Disabled	Allows more than two frequency ranges to be supported.

<p>Intel® Speed Shift Technology</p>	<p>Enabled Disabled[Default],</p>	<p>Enable/Disable Intel® Speed Shift Technology support. Enabling will expose the CPPC v2 interface to allow for hardware controlled P-states.</p>
<p>Turbo Mode</p>	<p>Enabled[Default], Disabled</p>	<p>Enable/Disable processor Turbo Mode (requires EMTTM enabled too). AUTO means enabled.</p>
<p>C States</p>	<p>Enabled Disabled[Default],</p>	<p>Enable/Disable CPU Power Management. Allows CPU to go to C states when it's not 100% utilized.</p>

4.6.2.2.1.1 View/Configure Turbo Options

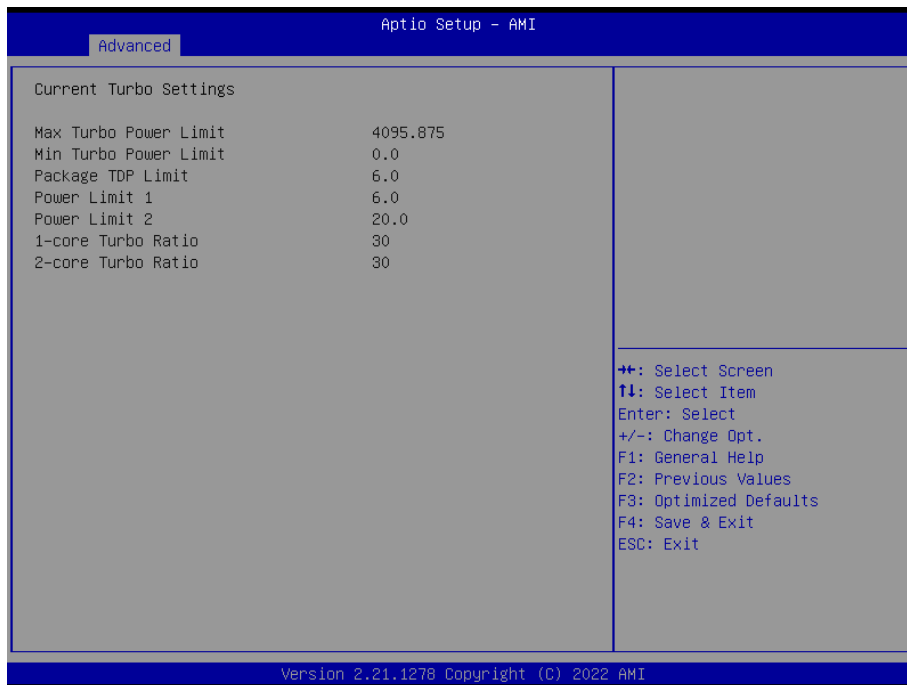

4.6.2.2.2 GT – Power Management Control

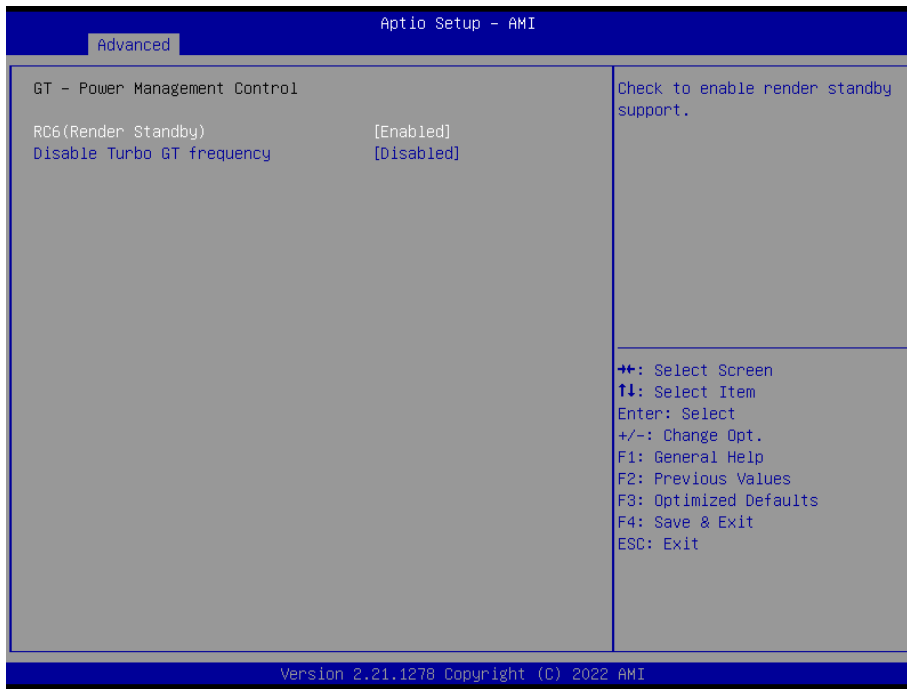

Item	Option	Description
RC6 (Render Standby)	Enabled[Default], Disabled	Check to enable render standby support.
Disable Turbo GT frequency	Enabled Disabled[Default]	Enabled: Disables Turbo GT frequency. Disabled: GT frequency is not limited.

4.6.2.3 PCH-FW Configuration

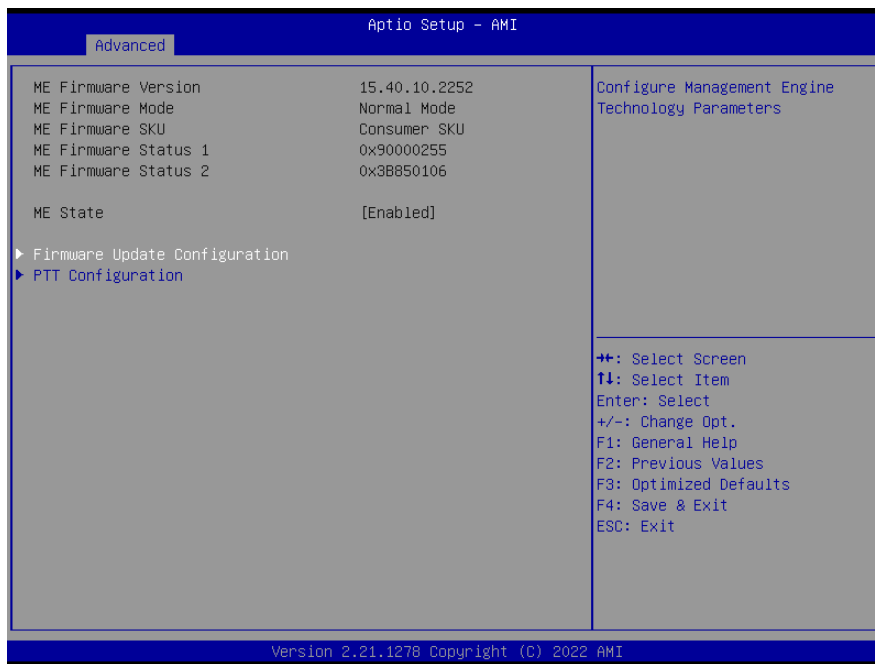

4.6.2.3.1 Firmware Update Configuration

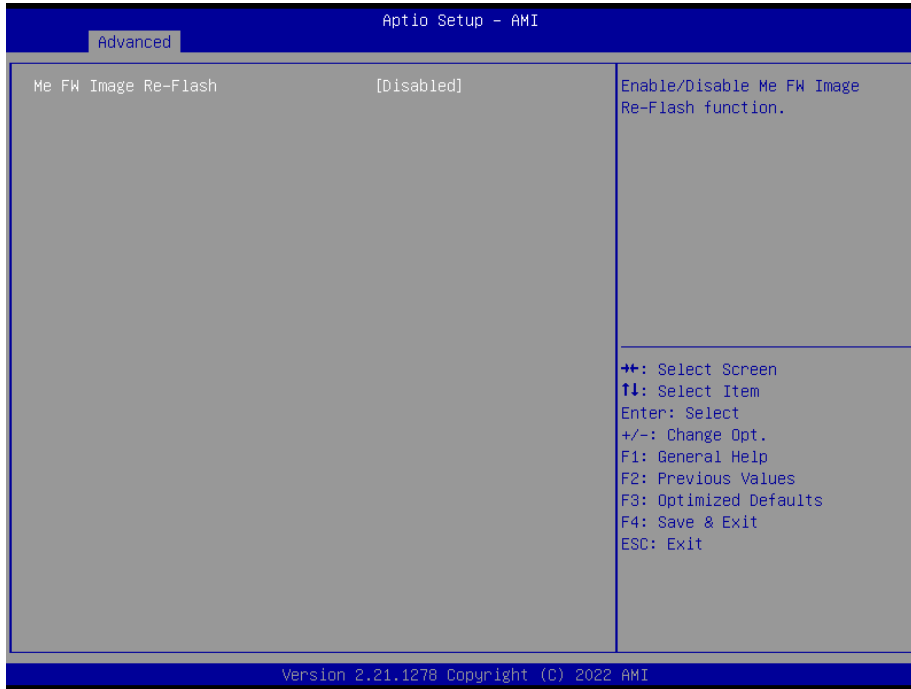

Item	Option	Description
ME FW Image Re-Flash	Disabled[Default], Enabled	Enable/Disable Me FW Image Re-Flash function.

4.6.2.3.2 PTT Configuration



Item	Option	Description
TPM Device Selection	dTPM[Default], PTT	Select TPM device: PTT or dTPM. PTT – Enables PTT in SkuMgr dTPM 1.2 – Disables PTT in SkuMgr Warning! PTT/dTPM will be disabled and all data saved on it will be lost.

4.6.2.4 Trusted Computing



Item	Options	Description
Security Device Support	Disable, Enable[Default]	Enables or Disables BIOS support for security device. O.S. will not show Security Device. TCG EFI protocol and INT1A interface will not be available.

4.6.2.5 ACPI Settings

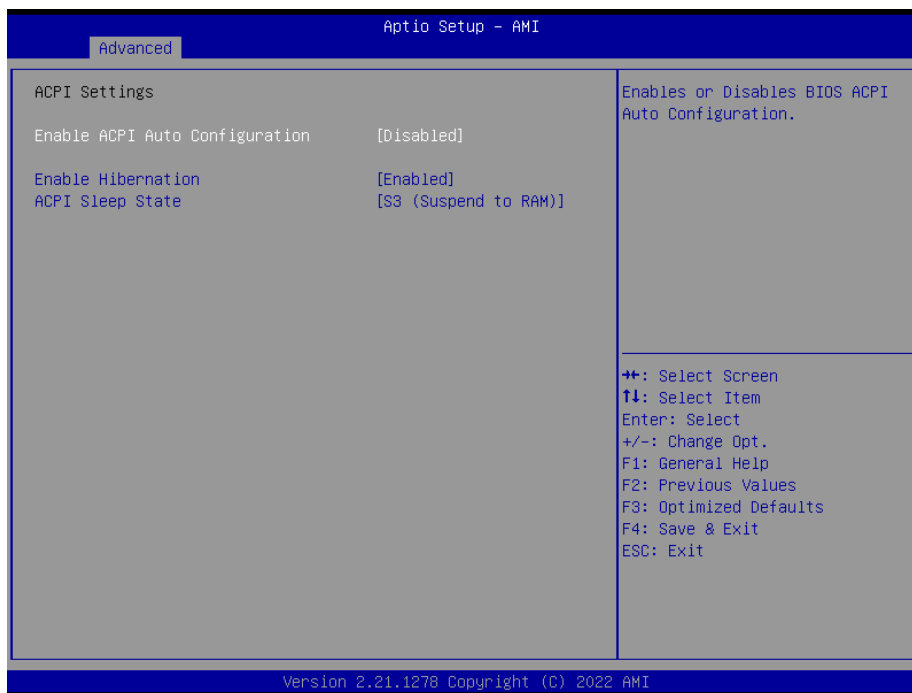

Item	Options	Description
Enable ACPI Auto Configuration	Disabled[Default], Enabled	Enables or Disables BIOS ACPI Auto Configuration.
Enable Hibernation	Disabled Enabled[Default],	Enables or Disables System ability to Hibernate (OS/S4 Sleep State). This option may not be effective with some OS.
ACPI Sleep State	Suspend Disabled, S3 (Suspend to RAM)[Default]	Select the highest ACPI sleep state the system will enter when the SUSPEND button is pressed.

4.6.2.6 Super IO Configuration

You can use this item to set up or change the Super IO configuration for serial ports. Please refer to 4.6.2.6.1 ~ 4.6.2.6.5 for more information.

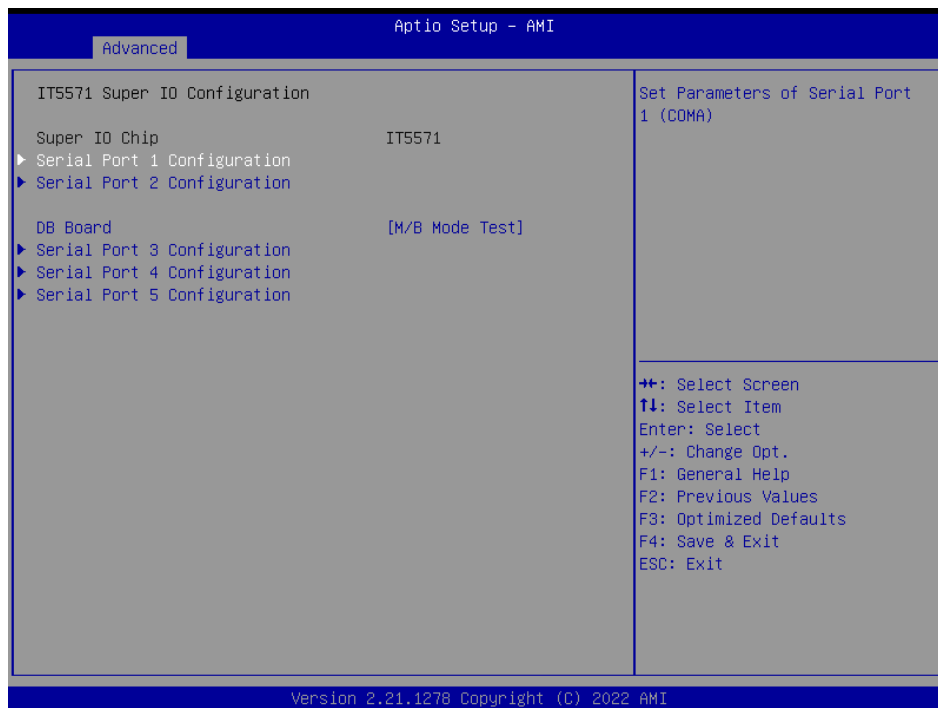

Item	Options	Description
DB Board	DB-A/C/E DB-B DB-F 1COM DB-D/H/K 2COM DB-G 3COM M/B Mode Test[Default],	DB Board A-K: DB-A/B/C/E w/o UART DB-G w/t 3UART DB-D/H/K w/t 2UART DB-F w/t 1UART.
Serial Port 1 Configuration	Set Parameters of Serial Port 1 (COMA).	
Serial Port 2 Configuration	Set Parameters of Serial Port 2 (COMB).	
Serial Port 3 Configuration	Set Parameters of Serial Port 3 (COMC).	
Serial Port 4 Configuration	Set Parameters of Serial Port 4 (COMD).	
Serial Port 5 Configuration	Set Parameters of Serial Port 5 (COME).	

4.6.2.6.1 Serial Port 1 Configuration

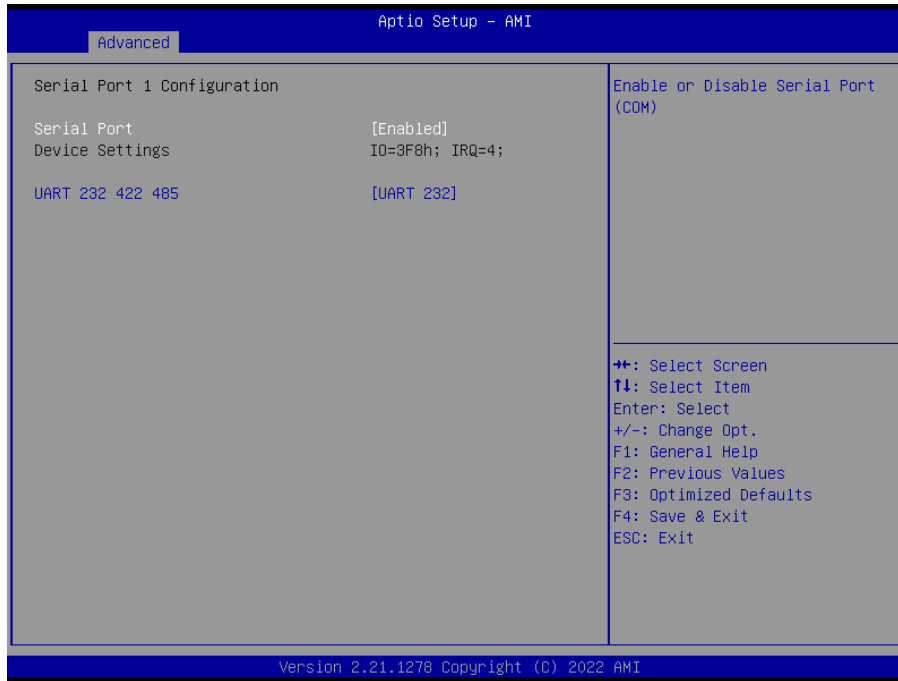

Item	Option	Description
Serial Port	Enabled[Default], Disabled	Enable or Disable Serial Port (COM).
UART 232 422 485	UART 232[Default] UART 422 UART 485	Change the Serial Port as RS232/422/485.

4.6.2.6.2 Serial Port 2 Configuration

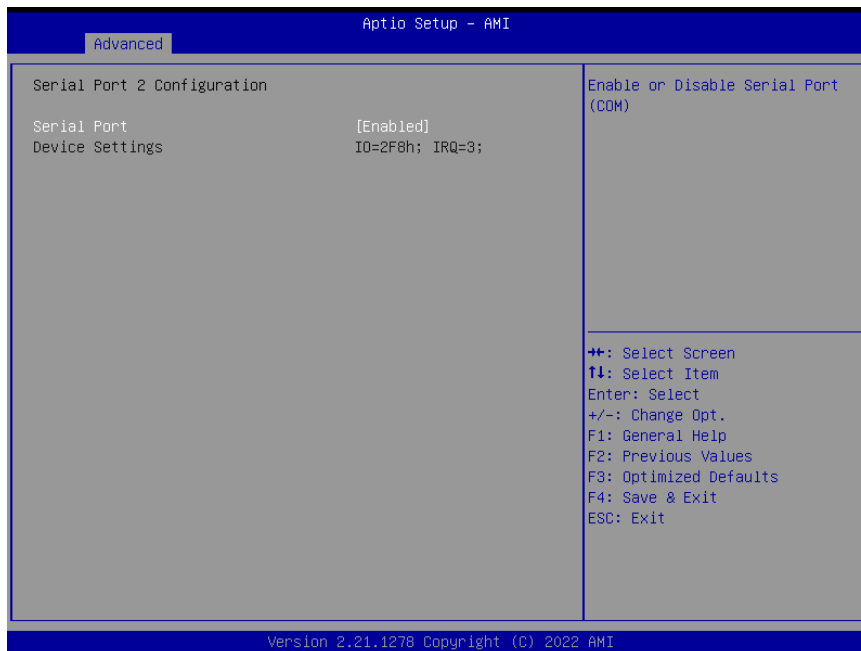

Item	Option	Description
Serial Port	Enabled[Default], Disabled	Enable or Disable Serial Port (COM).

4.6.2.6.3 Serial Port 3 Configuration

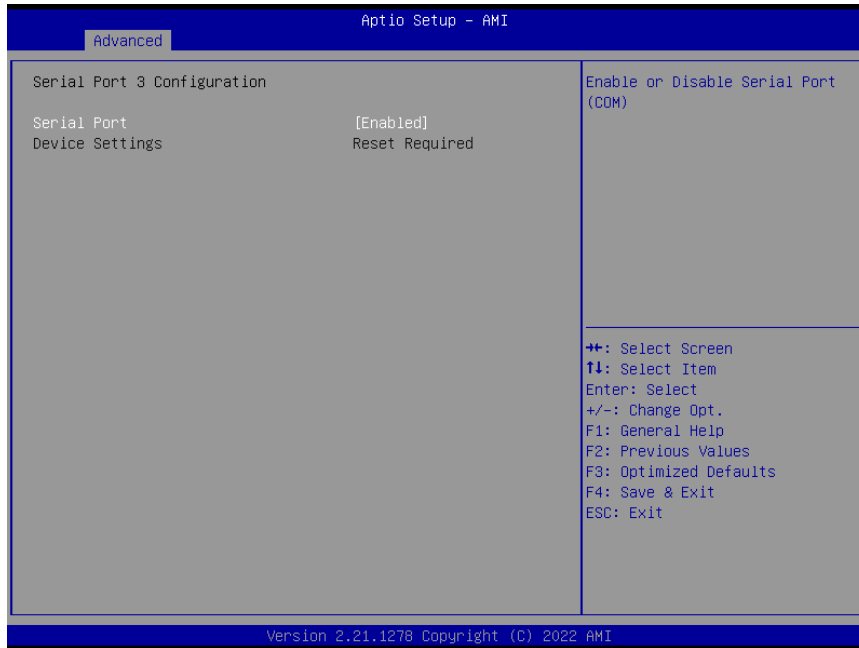

Item	Option	Description
Serial Port	Enabled[Default], Disabled	Enable or Disable Serial Port (COM).

4.6.2.6.4 Serial Port 4 Configuration



Item	Option	Description
Serial Port	Enabled[Default], Disabled	Enable or Disable Serial Port (COM).

4.6.2.6.5 Serial Port 5 Configuration

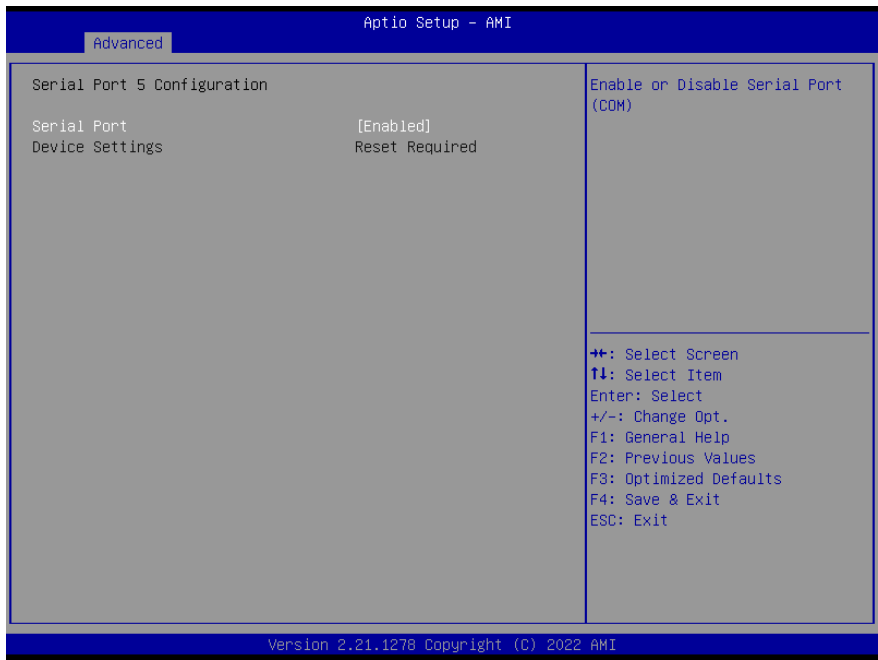

Item	Option	Description
Serial Port	Enabled[Default], Disabled	Enable or Disable Serial Port (COM).

4.6.2.7 EC 5571 HW Monitor

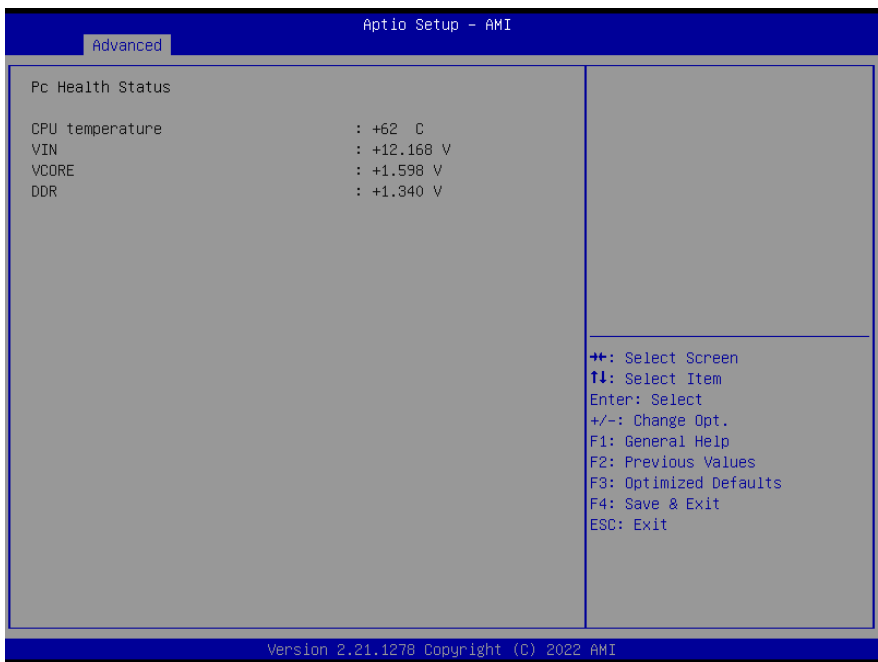

4.6.2.8 S5 RTC Wake Settings



Item	Options	Description
Wake system from S5	Disabled[Default], Fixed Time Dynamic Time	Enable or disable System wake on alarm event. Select Fixed Time, system will wake on the hr::min::sec specified. Select Dynamic Time, System will wake on the current time + Increase minute(s).

4.6.2.9 Serial Port Console Redirection



Item	Options	Description
Console Redirection	Disabled[Default], Enabled	Console Redirection Enable or Disable.
Console Redirection EMS	Disabled[Default], Enabled	Console Redirection Enable or Disable.

4.6.2.10 USB Configuration

The USB Configuration menu helps read USB information and configures USB settings.

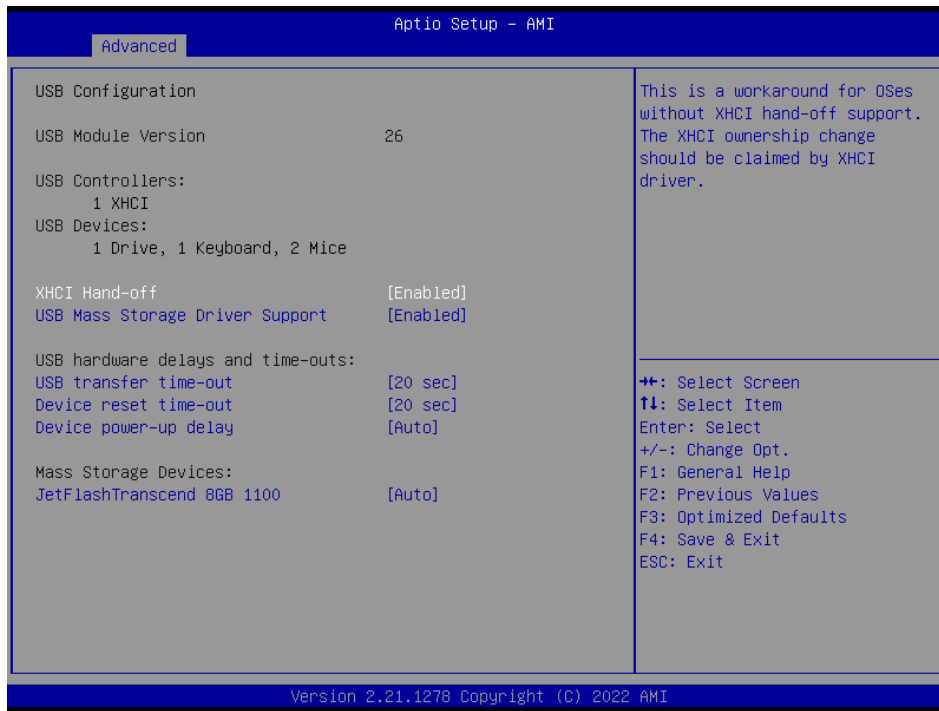

Item	Options	Description
XHCI Hand-off	Enabled[Default], Disabled	This is a workaround for OSES without XHCI hand-off support. The XHCI ownership change should be claimed by XHCI driver.
USB Mass Storage Driver Support	Disabled Enabled[Default],	Enable/Disable USB Mass Storage Driver Support.
USB transfer time-out	1 sec 5 sec 10 sec 20 sec[Default]	The time-out value for Control, Bulk, and Interrupt transfers.
Device reset time-out	10 sec 20 sec[Default] 30 sec 40 sec	USB mass storage device Start Unit command time-out.
Device power-up delay	Auto[Default] Manual	Maximum time the device will take before it properly reports itself to the Host Controller. 'Auto' uses default value: for a Root port it is 100ms, for a Hub port the delay is taken from Hub descriptor.
Mass Storage Devices	Auto[Default]	Mass storage device emulation type. 'AUTO'

	Floppy Forced FDD Hard Disk CD-ROM	enumerates devices according to their media format. Optical drives are emulated as 'CDROM', drives with no media will be emulated according to a drive type.
--	---	--

4.6.2.11 Network Stack Configuration



Item	Options	Description
Network Stack	Enabled Disabled[Default]	Enable/Disable UEFI Network Stack.

4.6.3 Chipset

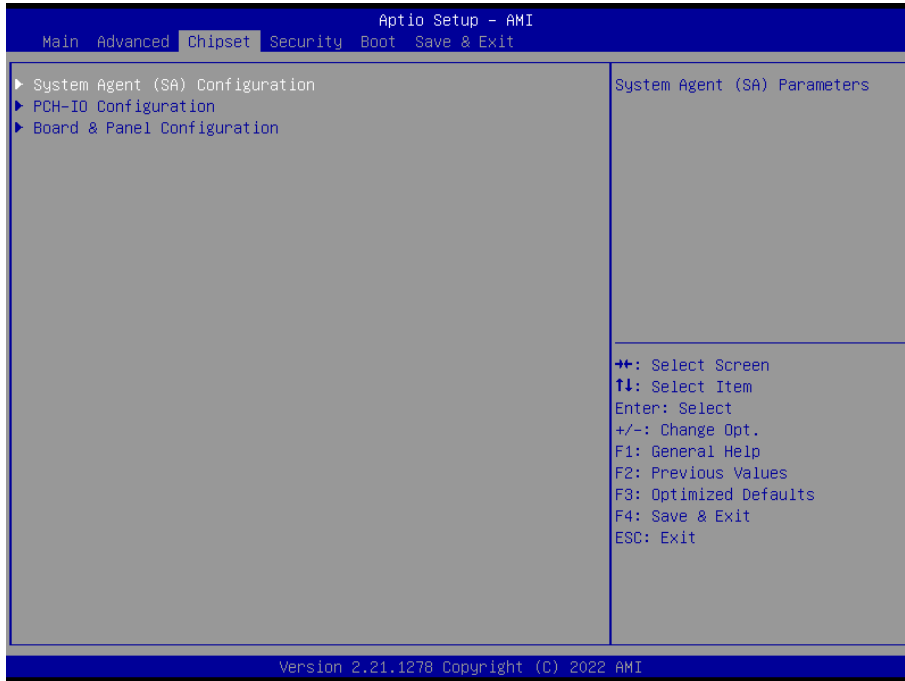

4.6.3.1 System Agent (SA) Configuration



Item	Option	Description
VT-d	Enabled[Default] Disabled	VT-d capability.
Above 4GB MMIO BIOS assignment	Enabled Disabled[Default]	Enable/Disable above 4GB MemoryMappedIO BIOS assignment. This is enabled automatically when Aperture Size is set to 2048MB.

4.6.3.1.1 Memory Configuration

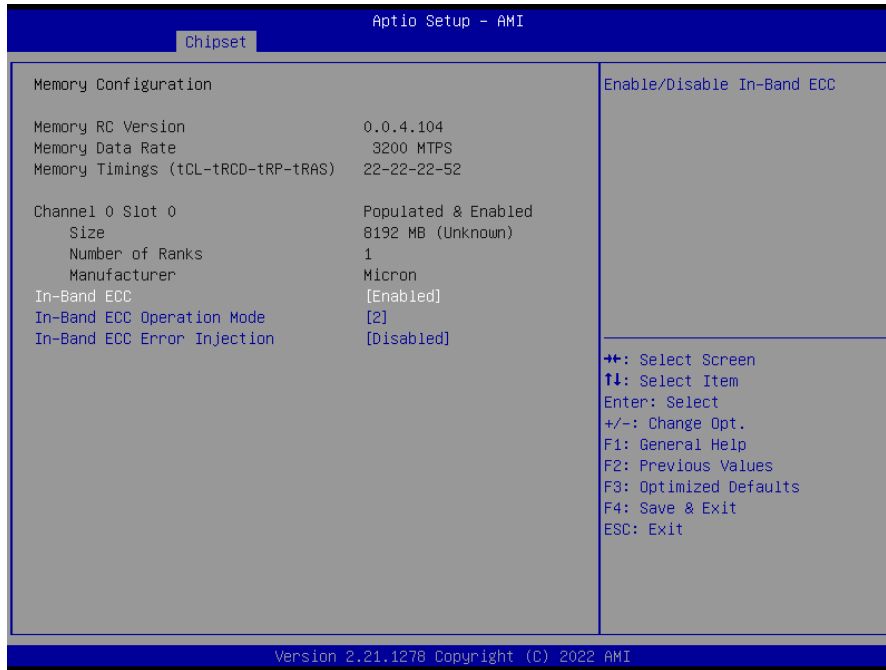

Item	Option	Description
In-Band ECC	Enabled[Default] Disabled	Enable/Disable In-Band ECC.
In-Band ECC Operation Mode	0 1 2[Default]	0: Functional Mode protects requests based on the address range, 1: Makes all requests non protected and ignore range checks, 2: Makes all requests protected and ignore range checks.
In-Band ECC Error Injection	Enabled Disabled[Default]	By enabling this Error Injection Enabling feature, the user acknowledges the security risks. Enabling Error Injection allows attackers who have access to the Host Operating System to inject IB ECC errors that can cause unintended memory corruption and enable the leak of security data in the BIOS stolen.

4.6.3.1.2 Graphics Configuration

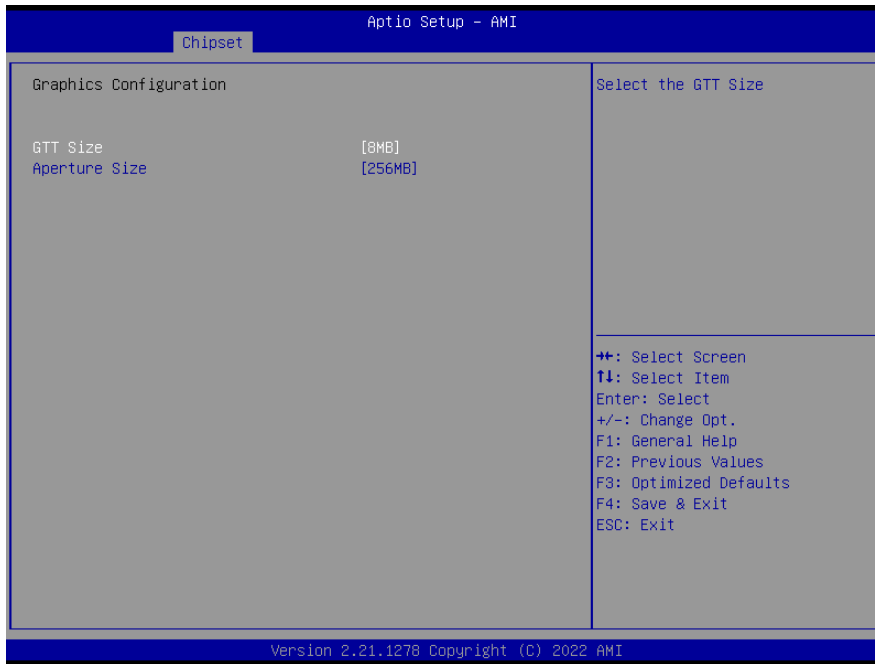

Item	Option	Description
GTT Size	2MB	Select the GTT Size.
	4MB	
	8MB[Default]	
Aperture Size	128MB	Select the Aperture Size. Note: Above 4GB MMIO BIOS assignment is automatically enabled when selecting 2048MB aperture. To use this feature, please disable CSM Support.
	256MB[Default]	
	512MB	
	1024MB	

4.6.3.2 PCH-IO Configuration

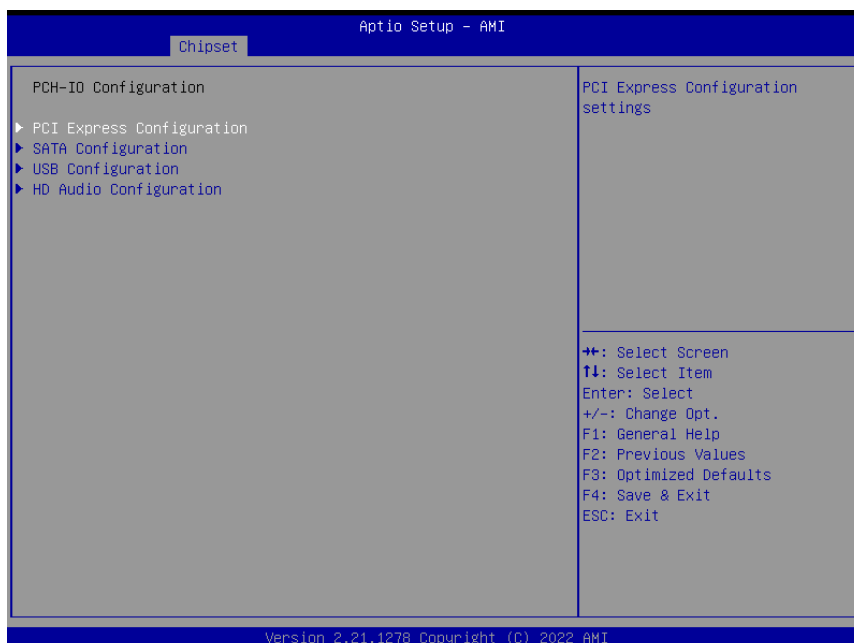

4.6.3.2.1 PCI Express Configuration

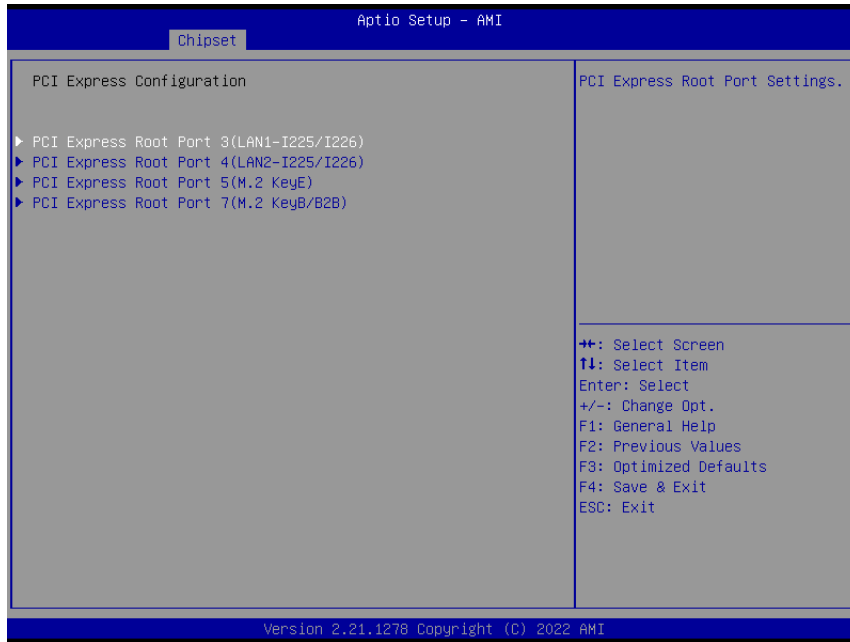

4.6.3.2.1.1 PCI Express Root Port 3(LAN1-I225/I226)

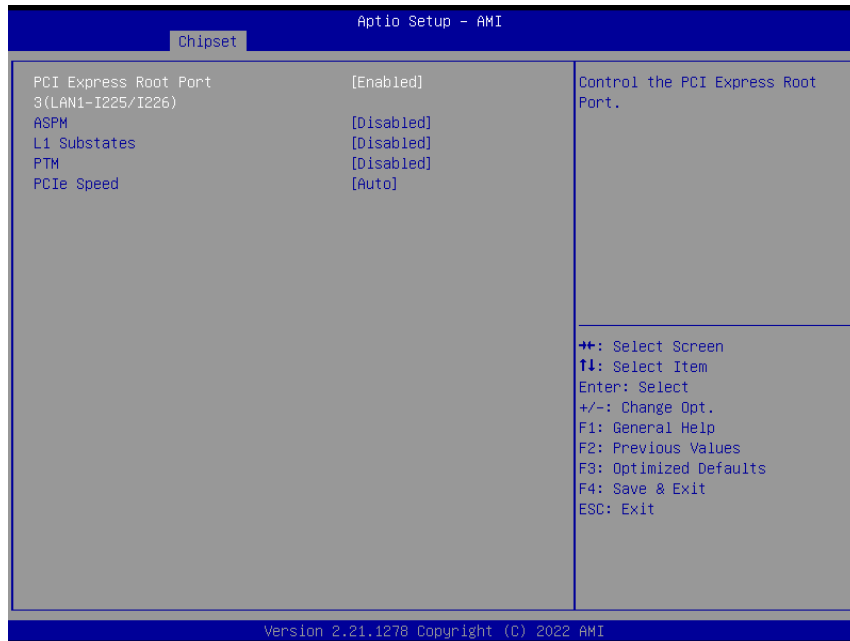

Item	Option	Description
PCI Express Root Port 3(LAN1-I225/I226)	Enabled[Default], Disabled	Control the PCI Express Root Port.
ASPM	Disabled[Default], L0s L1 L0sL1 Auto	Set the ASPM Level: Force L0s – Force all links to L0s State AUTO – BIOS auto configure DISABLE – Disables ASPM.

ARC-1535

L1 Substates	Disabled[Default] L1.1 L1.1 & L1.2	PCI Express L1 Substates settings.
PTM	Disabled[Default] Enabled	Enable/Disable Precision Time Measurement.
PCIe Speed	Auto[Default] Gen1 Gen2 Gen3	Configure PCIe Speed.

4.6.3.2.1.2 PCI Express Root Port 4(LAN2-I225/I226)

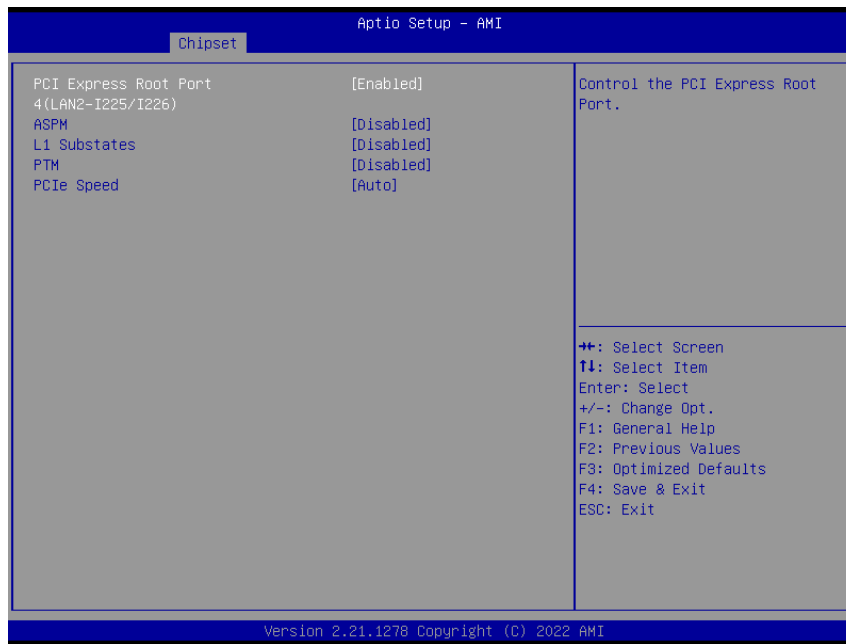

Item	Option	Description
PCI Express Root Port 4(LAN2-I225/I226)	Enabled[Default], Disabled	Control the PCI Express Root Port.
ASPM	Disabled[Default], L0s L1 L0sL1 Auto	Set the ASPM Level: Force L0s – Force all links to L0s State AUTO – BIOS auto configure DISABLE – Disables ASPM.
L1 Substates	Disabled[Default] L1.1 L1.1 & L1.2	PCI Express L1 Substates settings.
PTM	Disabled[Default] Enabled	Enable/Disable Precision Time Measurement.
PCIe Speed	Auto[Default] Gen1 Gen2 Gen3	Configure PCIe Speed.

4.6.3.2.1.3 PCI Express Root Port 5(M.2 KeyE)



Item	Option	Description
PCI Express Root Port 5(M.2 KeyE)	Enabled[Default], Disabled	Control the PCI Express Root Port.
ASPM	Disabled[Default], L0s L1 L0sL1 Auto	Set the ASPM Level: Force L0s – Force all links to L0s State AUTO – BIOS auto configure DISABLE – Disables ASPM.
L1 Substates	Disabled[Default], L1.1 L1.1 & L1.2	PCI Express L1 Substates settings.
PTM	Disabled[Default] Enabled	Enable/Disable Precision Time Measurement.
PCIe Speed	Auto[Default] Gen1 Gen2 Gen3	Configure PCIe Speed.

4.6.3.2.1.4 PCI Express Root Port 7(M.2 KeyB/B2B)

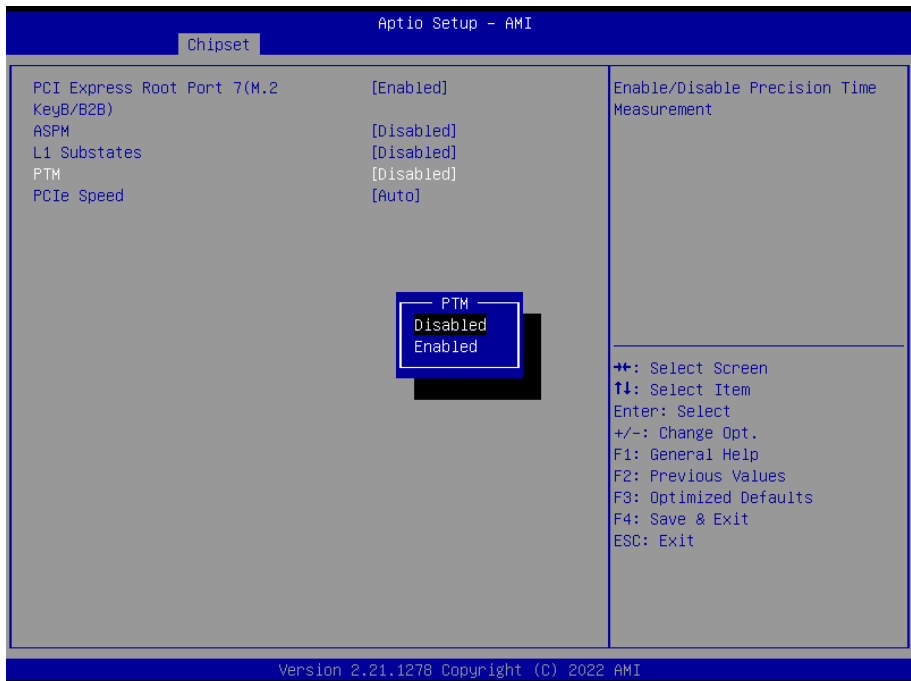

Item	Option	Description
PCI Express Root Port 7(M.2 KeyB/B2B)	Enabled[Default], Disabled	Control the PCI Express Root Port.
ASPM	Disabled[Default], L0s L1 L0sL1 Auto	Set the ASPM Level: Force L0s – Force all links to L0s State AUTO – BIOS auto configure DISABLE – Disables ASPM.

L1 Substates	Disabled[Default], L1.1 L1.1 & L1.2	PCI Express L1 Substates settings.
PTM	Disabled[Default] Enabled	Enable/Disable Precision Time Measurement.
PCIe Speed	Auto[Default] Gen1 Gen2 Gen3	Configure PCIe Speed.

4.6.3.2.2 SATA Configuration

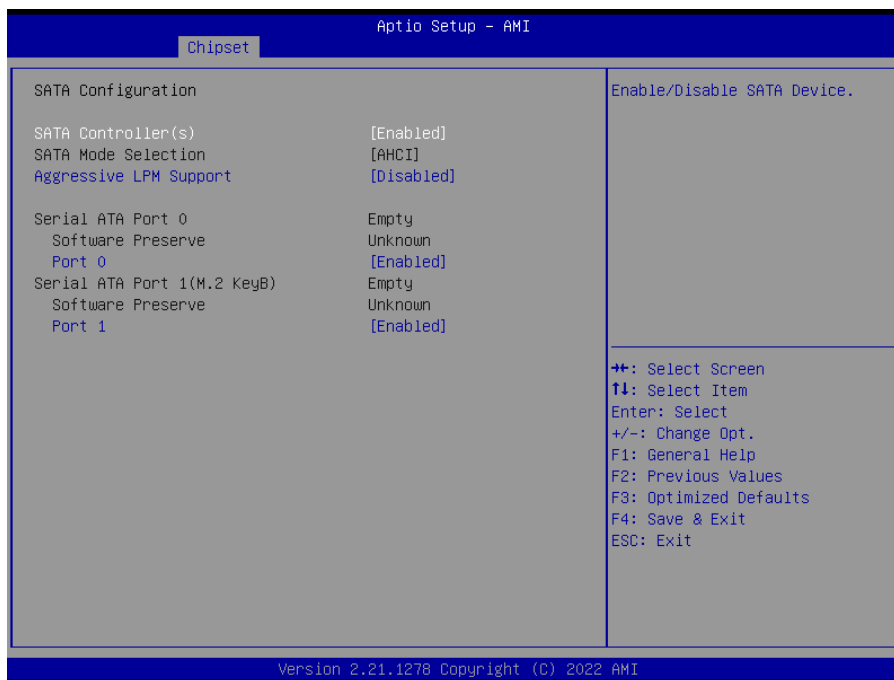

Item	Options	Description
SATA Controller(s)	Enabled[Default] Disabled,	Enable/Disable SATA Device.
Aggressive LPM Support	Enabled Disabled[Default]	Enable PCH to aggressively enter link power state.
Port 0	Enabled[Default] Disabled	Enable or Disable SATA Port.
Port 1	Enabled[Default] Disabled	Enable or Disable SATA Port.

4.6.3.2.3 USB Configuration



Item	Option	Description
XHCI Compliance Mode	Disabled[Default] Enabled	Option to enable Compliance Mode. Default is to disable Compliance Mode. Change to enabled for Compliance Mode testing.

4.6.3.2.4 HD Audio Configuration

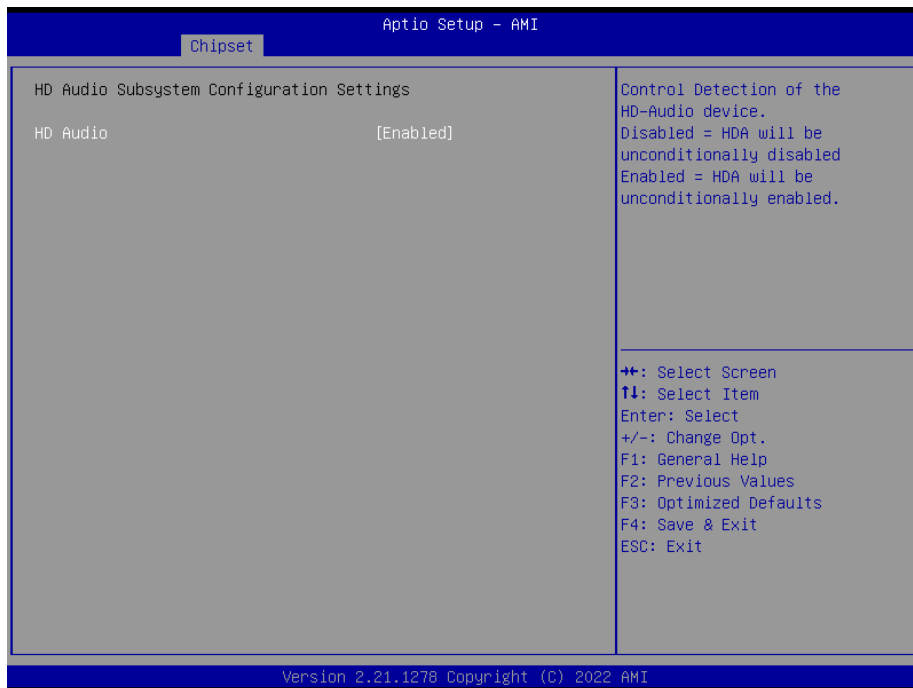

Item	Option	Description
HD Audio	Disabled Enabled[Default]	Control Detection of the HD-Audio device. Disable = HDA will be unconditionally disabled Enabled = HDA will be unconditionally enabled.

4.6.3.3 Board & Panel Configuration

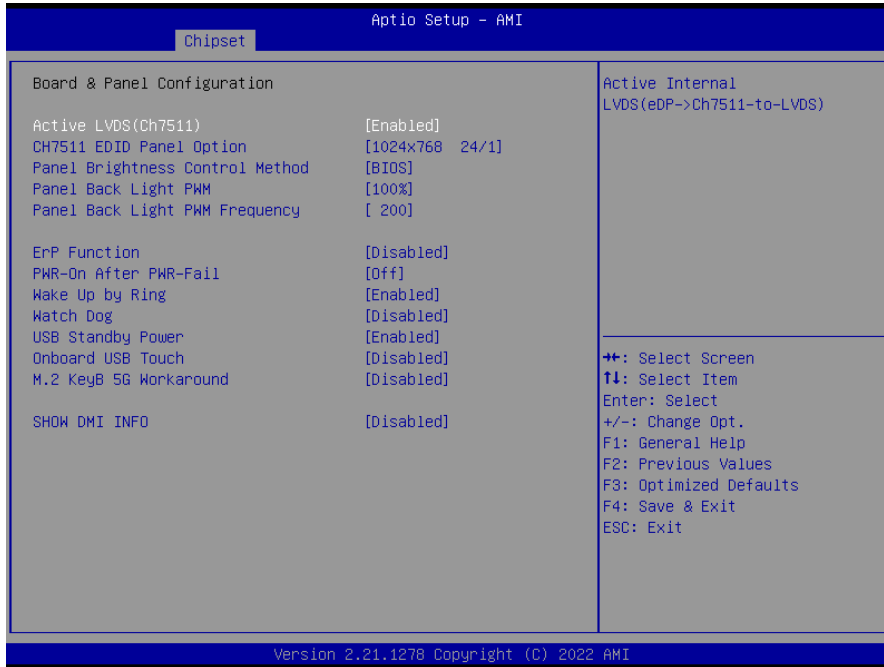

Item	Option	Description
Active Panel(Ch7511)	Disabled Enabled[Default]	Active Internal LVDS(eDP->Ch7511-to-LVDS).
CH7511 EDID Panel Option	1024x768 24/1[Default] 800x600 18/1 1024x768 18/1 1366x768 18/1 1024x600 18/1 1280x800 18/1 1920x1200 24/2 640x480 18/1 800x480 18/1 1920x1080 18/2 1280x1024 24/2 1440x900 18/2 1600x1200 24/2 1366x768 24/1 1920x1080 24/2 1680x1050 24/2	Port-EDP to LVDS(Chrotel 7511) Panel EDID Option.
Panel Brightness Control Method	BIOS[Default] OS Driver	Panel Brightness Control Method. 1.BIOS 2.OS Driver.
Panel Back Light PWM	00% 25% 50%	Select Panel(eDP/LVDS) back light PWM duty.

ARC-1535

	75% 100% [Default]	
Panel Back Light PWM Frequency	200 [Default] 300 400 500 700 1k 2k 3k 5k 10k 20k	Select Panel(eDP/LVDS) back light PWM Frequency.
ErP Function	Disabled [Default] Enabled	ErP Function (Deep S5).
PWR-On After PWR-Fail	Off [Default] On Last state	AC loss resume.
Wake Up by Ring	Disabled Enabled [Default]	Wake Up by Ring from S3/S4/S5.
Watch Dog	Disabled [Default] 30 sec 40 sec 50 sec 1 min 2 min 10 min 30 min	Select WatchDog.
USB Standby Power	Disabled Enabled [Default]	Enable/Disabled USB Standby Power during S3/S4/S5.
Onboard USB Touch	Disabled [Default] Enabled	Onboard USB Touch Enabled/Disabled.
M.2 KeyB 5G Workround	Disabled [Default] Enabled	Enabled/Disabled M.2 KeyB 5G Card Workaround
SHOW DMI INFO	Disabled [Default] Enabled	SHOW DMI INFO.

4.6.4 Security



- **Administrator Password**

Set setup Administrator Password

- **User Password**

Set User Password

4.6.4.1 Secure Boot



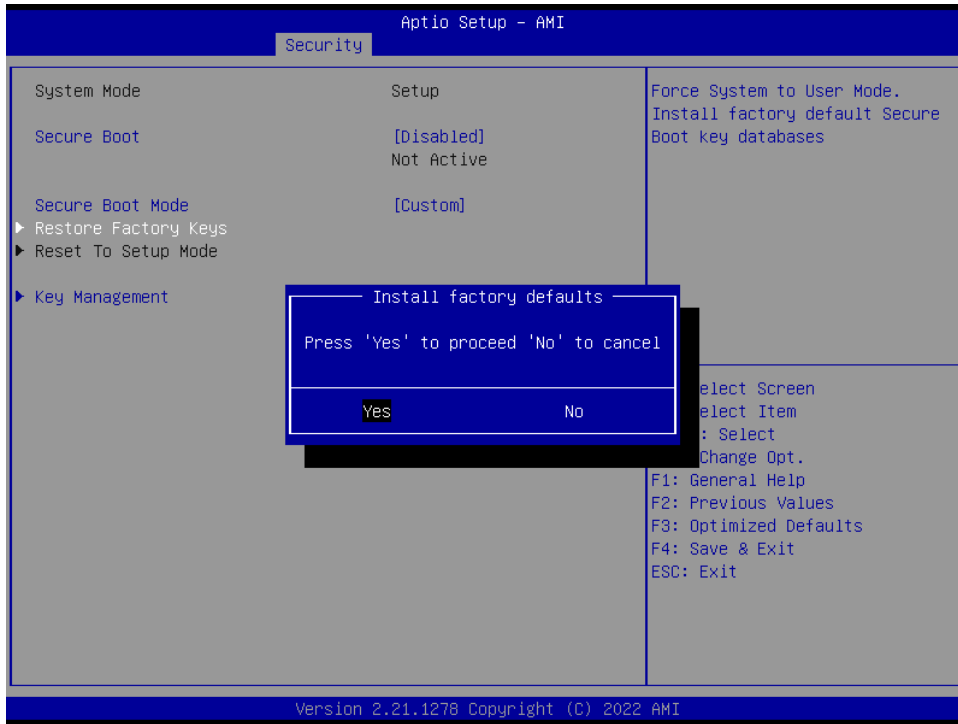

Item	Option	Description
Secure Boot	Disabled[Default] Enabled	Secure Boot feature is Active if Secure Boot is Enable, Platform Key(PK) is enrolled and the System is in User mode. The mode change requires platform reset.
Secure Boot Mode	Standard Custom[Default]	Secure Boot mode selector: Standard/Custom. In Custom mode Secure Boot Variables can be configured without authentication.

4.6.4.1.1 Key Management

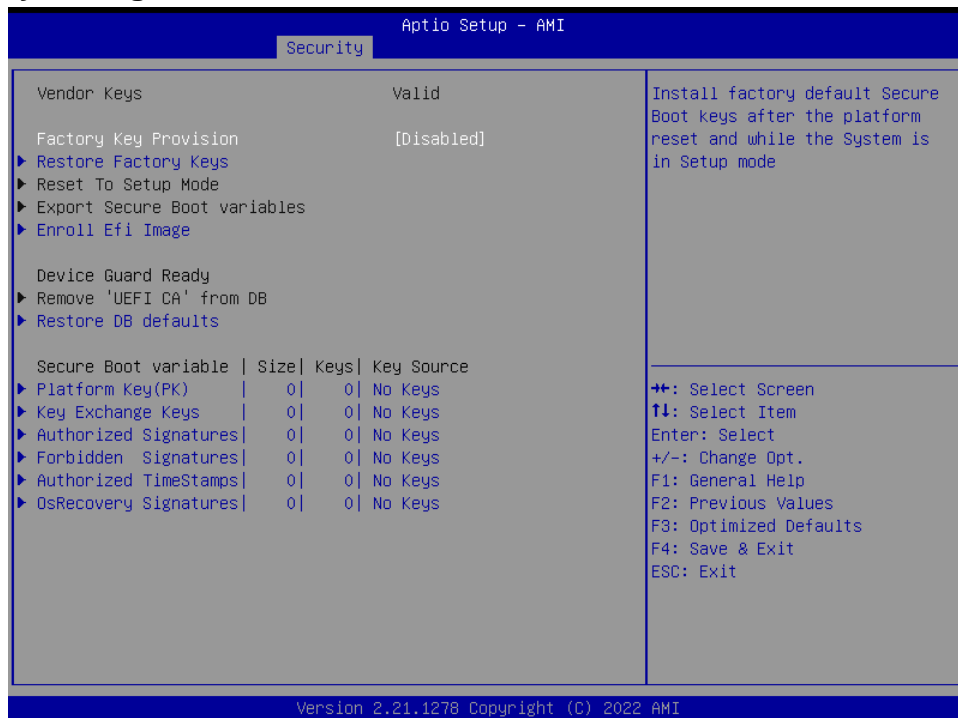

Item	Option	Description
Factory Key Provision	Disabled[Default] Enabled	Install factory default Secure Boot keys after the platform reset and while the System is in Setup mode.

4.6.5 Boot

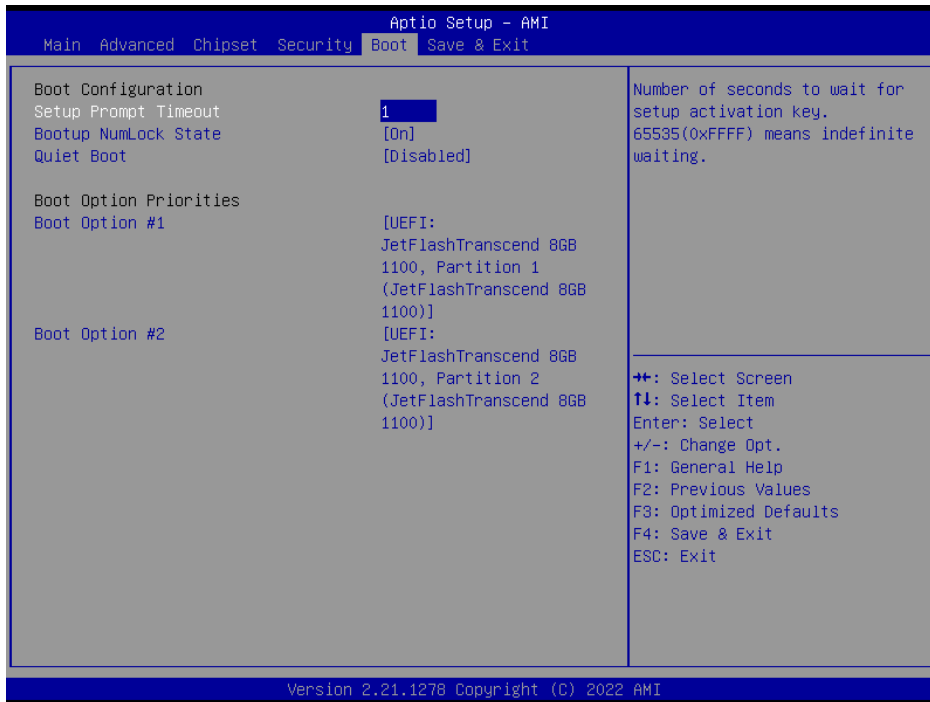

Item	Option	Description
Setup Prompt Timeout	1~ 65535	Number of seconds to wait for setup activation key. 65535(0xFFFF) means indefinite waiting.
Bootup NumLock State	On[Default] Off	Select the keyboard NumLock state
Quiet Boot	Disabled[Default] Enabled	Enables or disables Quiet Boot option
Fast Boot	Disabled[Default] Enabled	Enables or disables boot with initialization of a minimal set of devices required to launch active boot option. Has no effect for BBS boot optios.
Boot Option #1/2	Set the system boot order.	

4.6.6 Save and exit

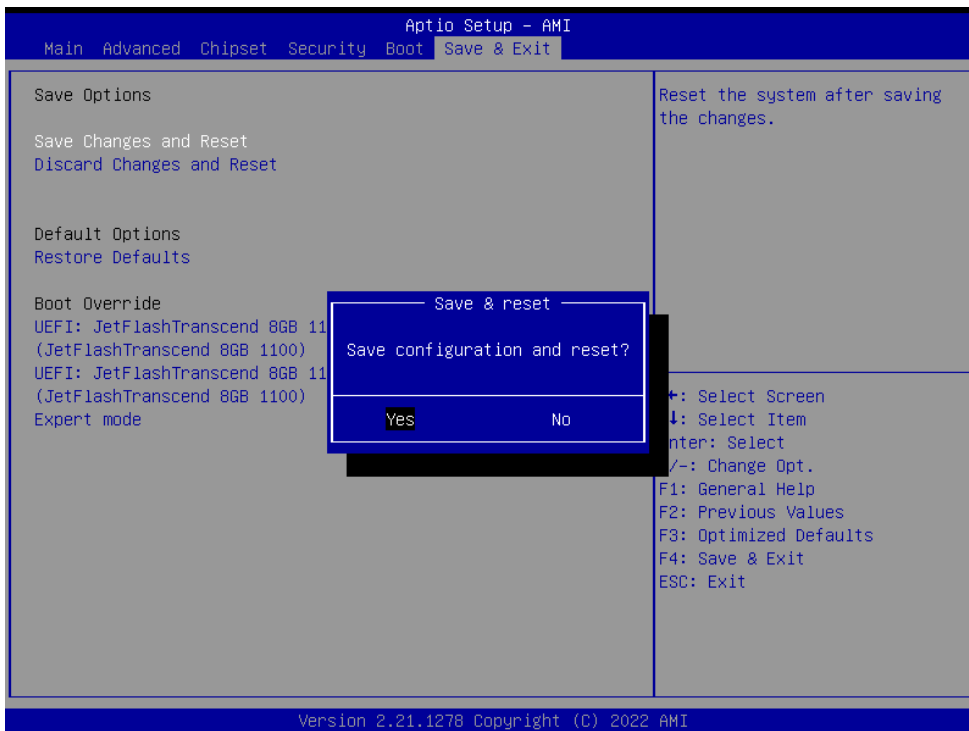
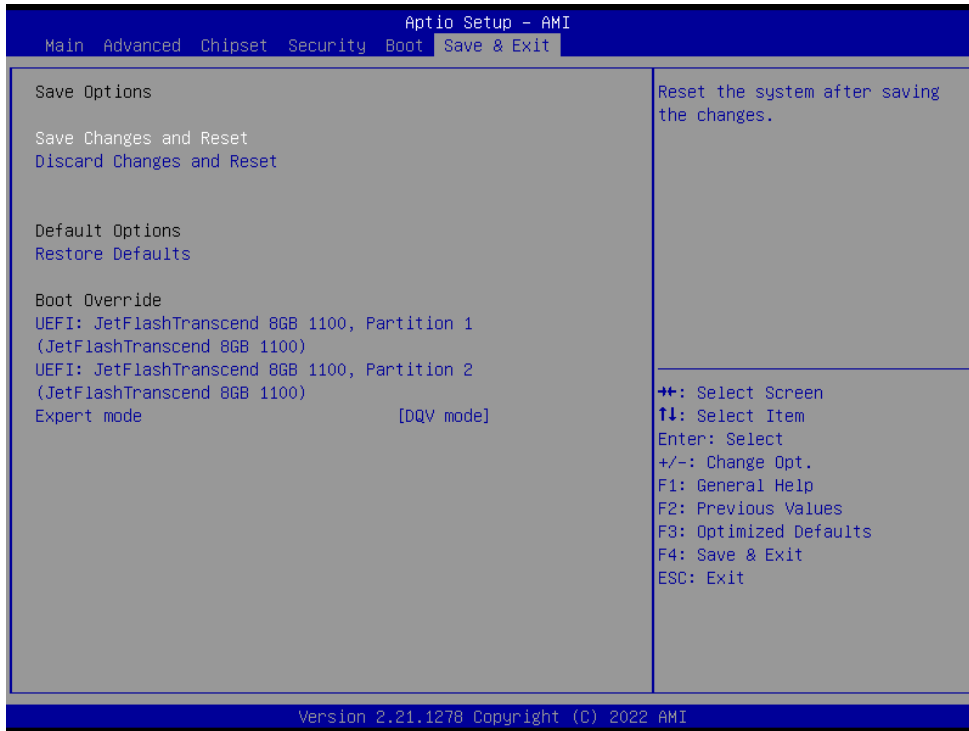

4.6.6.1 Save Changes and Reset

Reset the system after saving the changes.

4.6.6.2 Discard Changes and Reset

Any changes made to BIOS settings during this session of the BIOS setup program are discarded. The setup program then exits and reboots the controller.

4.6.6.3 Restore Defaults

This option restores all BIOS settings to the factory default. This option is useful if the controller exhibits unpredictable behavior due to an incorrect or inappropriate BIOS setting.

4.6.6.4 Launch EFI Shell from filesystem device

Attempts to Launch EFI Shell application (Shellx64.efi) from one of the available filesystem devices.

5. Maintenance & Troubleshooting

System Maintenance Introduction

If the components of the product fail they must be replaced.

Please contact the system reseller or vendor to purchase the replacement parts. Please follow the safety precautions outlined in the sections that follow

General Safety Precautions

Please ensure the following safety precautions are adhered to at all times.

1. Follow the electrostatic precautions outlined below whenever the device is opened.
2. Make sure the power is turned off and the power cord is disconnected whenever the product is being installed, moved or modified.
3. To prevent the risk of electric shock, make sure power cord is unplugged from wall socket. To fully disengage the power to the unit, please disconnect the power cord from the AC outlet. Refer servicing to qualified service personnel. The AC outlet shall be readily available and accessible.
4. Do not apply voltage levels that exceed the specified voltage range. Doing so may cause fire and/or an electrical shock. Use a power cord that matches the voltage of the power outlet, which has been approved and complies with the safety standard of your particular country.
5. Electric shocks can occur if the product chassis is opened when it is running. To avoid risk of electric shock, this device must only be connected to a supply mains with protective earth.
6. Do not drop or insert any objects into the ventilation openings of the product.
7. If considerable amounts of dust, water, or fluids enter the device, turn off the power supply immediately, unplug the power cord, and contact your dealer or the nearest service center.
8. This equipment is not suitable for use in locations where children are likely to be present.
9. DO NOT:
 - Drop the device against a hard surface.
 - Strike or exert excessive force onto the LCD panel.
 - Touch any of the LCD panels with a sharp object.
 - In a site where the ambient temperature exceeds the rated temperature.

Anti-Static Precautions

WARNING:

Failure to take ESD precautions during the installation of the product may result in permanent damage to the product and severe injury to the user.

Electrostatic discharge (ESD) can cause serious damage to electronic components, including the product. Dry climates are especially susceptible to ESD. It is therefore critical that whenever the product is opened and any of the electrical components are handled, the following anti-static precautions are strictly adhered to.

- **Wear an anti-static wristband:** Wearing a simple anti-static wristband can help to prevent ESD from damaging any electrical component.
- **Self-grounding:** Before handling any electrical component, touch any grounded conducting material. During the time the electrical component is handled, frequently touch any conducting materials that are connected to the ground.
- **Use an anti-static pad:** When configuring or working with an electrical component, place it on an anti-static pad. This reduces the possibility of ESD damage.
- **Only handle the edges of the electrical component.** When handling the electrical component, hold the electrical component by its edges. Please ensure the following safety precautions are adhered to at all times.

Maintenance and Cleaning

When maintaining or cleaning the product, please follow the guidelines below.

WARNING:

- For safety reasons, turn-off the power and unplug the panel PC before cleaning.
- If you dropped any material or liquid such as water onto the panel PC when cleaning, unplug the power cable immediately and contact your dealer or the nearest service center. Always make sure your hands are dry when unplugging the power cable.

Maintenance and Cleaning

Prior to cleaning any part or component of the product, please read the details below.

- Except for the LCD panel, never spray or squirt liquids directly onto any other components. To clean the LCD panel, gently wipe it with a piece of soft dry cloth or a slightly moistened cloth.
- The interior of the device does not require cleaning. Keep fluids away from the device interior.
- Be cautious of all small removable components when vacuuming the device.
- Never drop any objects or liquids through the openings of the device.
- Be cautious of any possible allergic reactions to solvents or chemicals used when cleaning the device.
- Avoid eating, drinking and smoking within vicinity of the device.

Cleaning Tools

Some components in the panel PC may only be cleaned using a product specifically designed for the purpose. In such case, the product will be explicitly mentioned in the cleaning tips. Below is a list of items to use when cleaning the panel PC.

- Cloth: Although paper towels or tissues can be used, a soft, clean piece of cloth is recommended when cleaning the device.
- Water or rubbing alcohol: A cloth moistened with water or rubbing alcohol can be used to clean the device.
- Using solvents: The use of solvents is not recommended when cleaning the device as they may damage the plastic parts.
- Vacuum cleaner: Using a vacuum specifically designed for computers is one of the best methods of cleaning the device. Dust and dirt can restrict the airflow in the device and cause its circuitry to corrode.
- Cotton swabs: Cotton swabs moistened with rubbing alcohol or water are excellent tools for wiping hard to reach areas.
- Foam swabs: Whenever possible, it is best to use lint free swabs such as foam swabs for cleaning.

Basic Troubleshooting

PEI Beep Codes

# of Beeps	Description
1	Memory not Installed
2	Recovery started
3	Typically for development use. The beep code is generated when DXE IPL PPI or DXE Core is not found.
4	Recovery failed
4	S3 Resume failed
7	Typically for development use. The beep code is generated when platform cannot be reset because reset PPI is not available.

DXE Beep Codes

# of Beeps	Description
1	Invalid password
4	Typically for development use. The beep code is generated when some of the Architectural Protocols are not available.
5	No Console Input or Output Devices are found
5	No Console Input Devices are found
6	Flash update is failed
7	Typically for development use. The beep code is generated when platform cannot be reset because reset protocol is not available.
8	Platform PCI resource requirements cannot be met

6. Product Application

For detailed instructions on the operation of the Watchdog Timer and Digital I/O (DIO) features of this Panel PC, please refer to the comprehensive guide available in the "AvalueIOAPI" manual. Please reaching out to your respective distributors, Avalue technical support team, or Avalue customer service representatives for further information. Feel free to inquire about this supplementary resource to enhance your understanding of the Watchdog Timer and Digital I/O (DIO) Application for optimal utilization of your Panel PC.

7. Operating the Device

The Multi-Touch mode was pre-installed on the Panel PC and need tools for any customizations. Should you have specific requirements or encounter scenarios where a customized touch mode is necessary, we recommend reaching out to your local distributors, Avalue technical support team, or Avalue customer service representatives. These professionals can provide tailored guidance and assistance to address any unique needs related to Multi-Touch mode adjustments.