

# Avalue Intelligent Display & System

## HID-2138

21.5" Tiger Lake Medical Multi-Touch Panel PC

### User Manual

---

3<sup>rd</sup> Ed- 06 March 2024

Copyright © 2024 Avalue Technology Inc., All Rights Reserved.

DMR Number: T73945-00  
Rev: 3<sup>rd</sup>

Part No: E2017H180A2R

## Instructions for the User

The document combines text and illustrations, providing a comprehensive overview of the system. The information is presented as a sequential steps of actions, allowing the user to learn directly how to use the device. The text provides explanations and instructs the user step-by-step in the practical use of the product, with short, clear instructions in an easy-to-follow sequence.

- Non-patient at least 18 years old with basic reading experience.
- Read and understand “westernized Arabic numbers” when written in Arial font
- Can distinguish human organs and understand hygiene.
- Understand languages as specified in the marketing plan (Ext: Chinese, English...).
- For general function operation and maintenance, no special experiences are required.
- Mechanical tool operation knowledge is needed when installing mounting. Please contact a service technician or your retailer.

## Purposes and Applications

HID-2138 is intended to be used in healthcare institutions for general purpose as an assisting device for data access – patient information, medical records, media services, and so on. The product is designed for general or special use in the hospital environment.

## Operating principle

A Medical Panel PC has four main components: the arithmetic logic unit (ALU), the control unit, the memory, and the input and output devices (collectively termed I/O). These parts are interconnected by buses, often made of groups of wires.

The control unit, ALU, and registers are collectively known as a central processing unit (CPU). Inside each of these parts are thousands to trillions of small electrical circuits which can be turned off or on by means of an electronic switch. Each circuit represents a bit (binary digit) of information so that when the circuit is on it represents a "1", and when off it represents a "0" (in positive logic representation). The circuits are arranged in logic gates so that one or more of the circuits may control the state of one or more of the other circuits.

## Definitions

**Warning!** A **WARNING** statement provides important information about a potentially hazardous situation which, if not avoided, could result in death or serious injury.



**Caution!** A **CAUTION** statement provides important information about a potentially hazardous situation which, if not avoided, may result in minor or moderate injury to the user or patient or in damage to the equipment or other property.



**Note!** A **NOTE** provides additional information intended to avoid inconveniences during operation.



## Safety Instructions

1. Strictly follow these Instructions for Use, please read these safety instructions carefully.
2. Remind to keep this User's Manual for later reference, and any use of the product requires full understanding and strict observation of all portions of these instructions. Observe all **WARNINGS** and **CAUTIONS** as rendered throughout this manual and on labels on the equipment.
3. Repair of the device may also only be carried out by **MANUFACTURER**.

**Warning!** *Because of the danger of electric shock, never remove the cover of a device while it is in operation or connected to a power outlet.*



4. If one of the following situations arises, please refer to the solutions:

Problem	Solution
The power cord or plug is damaged.	Contact manufacturer for further inspection.
Liquid has penetrated equipment.	Try to dry up excess liquid and contact manufacturer for further inspection.
The equipment does not power on.	<ol style="list-style-type: none"> <li>1. Check the adapter model to see if it is correct.</li> <li>2. Confirm whether power adapter and power cord is properly connected.</li> <li>3. If the problem still exists, contact manufacturer for further inspection.</li> </ol>
The equipment has been damaged.	<ol style="list-style-type: none"> <li>1. Power on the equipment to confirm whether the function is still normal.</li> <li>2. Contact manufacturer for repairment if needed.</li> </ol>

5. Disconnect this equipment from any AC outlet before cleaning. Use a damp cloth. Do not use liquid or spray detergents for cleaning and keep this equipment away from humidity.

**Caution!** *To avoid short-circuiting and otherwise damaging the device, do not allow fluids to come in contact with the device. If fluids are accidentally spilled on the equipment, remove the affected unit from service as soon as possible and contact the service personnel to verify that patient safety is not compromised.*



6. Put this equipment on a reliable surface during installation. Dropping it or letting it fall may cause damage. For plug-in equipment, the power outlet socket must be located near the equipment and must be easily accessible.

**Caution!** *To prevent overheating, do not cover the openings and place the device in direct sunlight or near radiant heaters.*



7. Make sure the voltage of the power source is correct before connecting the equipment to the power outlet. Position the power cord so that people cannot step on it. Do not place anything over the power cord. If the equipment is not used for a long time, disconnect it from the power source to avoid damage by transient over voltage.

**Caution!** *Do not leave this equipment in an uncontrolled environment where the storage temperature is below -20° C (-4° F) or above 60° C (140° F). this may damage the equipment.*



8. If your computer is losing dramatic time or the BIOS configuration reset to default, the battery has no power.

**Caution!** *Do not replace battery yourself. Please contact MANUFACTURER. The computer is provided with a battery-powered real-time clock circuit. There is a danger of explosion if battery is incorrectly replaced. Replace only with same or equivalent type recommended by the manufacture. Discard used batteries according to the manufacturer's instructions*



9. Improper installation of VESA mounting can result in serious personal injury! VESA mount installation should be operated by professional technician, please contact the service technician or your retail if you need this service.

10. Environmental protection: follow national requirements to dispose of unit.

11. Maintenance: to properly maintain and clean the surfaces, use only the approved products or clean with a dry applicator.

12. Make sure the user not to contact SIP/SOPs and the patient at the same time.

13. When networking with electrical devices, the operator is responsible for ensuring that the resulting system meets the requirements set forth by the following standards:

– EN 60601-1 (IEC 60601-1)

Medical electrical equipment

Part 1: General requirements for safety

– EN 60601-1-1 (IEC 60601-1-1)

Medical electrical equipment

Part 1-1: General requirements for safety

Collateral standard: Safety requirements for Medical electrical systems

– EN 60601-1-2 (IEC 60601-1-2)

Medical electrical equipment

Part 1-2: General requirements for safety

Collateral standard: Electromagnetic compatibility; Requirements and tests



MEDICAL - GENERAL MEDICAL EQUIPMENT AS TO ELECTRICAL SHOCK, FIRE AND MECHANICAL HAZARDS ONLY IN ACCORDANCE ANSI/AAMI ES60601-1 (2005) + AMD 1 (2012) CAN/CSA-C22.2 No. 60601-1 (2014)

14. Accessory equipment connected to the analog and digital interfaces must be in compliance with the respective nationally harmonized IEC standards (i.e. IEC 60950 for data processing equipment, IEC 60065 for video equipment, IEC 61010-1 for laboratory equipment, and IEC 60601-1 for medical equipment.) Furthermore, all configurations shall comply with the system standard IEC 60601-1-1. Everybody who connects additional equipment to the signal input part or signal output part configures a medical system, and is therefore, responsible that the system complies with the requirements of the system standard IEC 60601-1-1. The unit is for exclusive interconnection with IEC 60601-1 certified equipment in the patient environment and IEC 60601-1 certified equipment outside of the patient environment. If in doubt, consult the technical services department or your local representative.

**Caution!** Use suitable mounting apparatus to avoid risk of injury.



15. Use a power cord that matches the voltage of the power outlet, which has been approved and complies with the safety standard of your country.

**Note!** Environmental protection Follow national requirements to dispose of unit.



**Warning!** Do not modify this equipment without authorization of the manufacturer.



**Warning!** To avoid risk of electric shock, this equipment must only be connected to a supply main with protective earth.



**Caution!** *This adapter EDAC EM11013C is a forming part of the medical device.*



16. The design of Internal Smart battery is considered for backup purpose while system accidentally loosing main power supply in any situation, it will supply max.6mins of the operating time to keep let user backup the data and shut down the system properly.











**Caution!** *Do not attempt to disassemble the battery pack. There is danger of excessive temperatures, fire or explosion if the battery is incorrectly replaced. Please contact with MANUFACTURER to replace battery packs.*

**Caution!** *Do not use the power adapter that isn't made for the equipment, supplying the equipment with inappropriate voltage may cause harm to the battery (if any) or even worse burn the equipment.*









17. The product is not used in Category AP or Category APG in an anesthetic gas environment.

## Explanation of Graphical Symbols

	<p>Warning: dangerous voltage</p>
	<p>Caution</p>
	<p>Note</p>
	<p>ISO 7000-1641: Follow operating instructions or Consult instructions for use.</p>
	<p>Direct current.</p>
	<p>Equipotential</p>
	<p>Stand-by</p>
	<p>US Conformance</p>
	<p>Follow the national requirements for disposal of equipment.</p>
	<p>Stacking layer limit</p>
	<p>This side up</p>

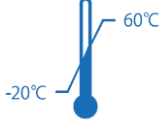

	Fragile Packaging
	Beware of water damage, moisture-proof
	Carton recyclable
	Handle with care
	Storage & Transportation Temperature: -20°C ~ 60°C
	Storage & Transportation Humidity: 10% ~ 95%

## Disposing of your old product

### Within the European Union

EU-wide legislation, as implemented in each Member State, requires that waste electrical and electronic products carrying the mark (left) must be disposed of



separately from normal household waste. This includes monitors and electrical accessories, such as signal cables or power cords. When you need to dispose of your display products, please follow the guidance of your local authority, or ask the shop where you purchased the product, or if applicable, follow any agreements made

between yourself. The mark on electrical and electronic products only applies to the current European Union Member States.



## **Federal Communication Commission Interference Statement**

**THIS DEVICE COMPLIES WITH PART 15 OF THE FCC RULES. OPERATION IS SUBJECT TO THE FOLLOWING TWO CONDITIONS: (1) THIS DEVICE MAY NOT CAUSE HARMFUL INTERFERENCE AND (2) THIS DEVICE MUST ACCEPT ANY INTERFERENCE RECEIVED, INCLUDING INTERFERENCE THAT MAY CAUSE UNDESIRE OPERATION.**

**Note:** This equipment has been tested and found to comply with the limits for a Class B digital device, pursuant to Part 15 of FCC Rules. These limits are designed to provide reasonable protection against harmful interference in a residential installation. This equipment generates, uses and can radiate radio frequency energy and, if not installed and used in accordance with the instruction, may cause harmful interference to radio communications. However, there is no guarantee that interference will not occur in a particular installation. If this equipment does cause harmful interference to radio or television reception, which can be determined by turning the equipment off and on, the user is encouraged to try to correct the interference by one or more of the following measures:

- Reorient or relocate the receiving antenna.
- Increase the separation between the equipment and receiver.
- Connect the equipment into an outlet on a circuit different from the one the receiver is connected to.
- Consult the dealer or an experienced radio/TV technician for help.

**Notice:**

- (1) A Unshielded-type power cord is required in order to meet FCC emission limits and also to prevent interference to the nearby radio and television reception. It is essential that only the supplied power cord be used.
- (2) Use only shielded cables to connect I/O devices to this equipment.
- (3) Changes or modifications not expressly approved by the party responsible for compliance could void the user's authority to operate the equipment.

## **FCC RF Radiation Exposure Statement**

**This equipment complies with FCC radiation exposure limits set forth for an uncontrolled environment. This equipment should be installed and operated with minimum distance 20cm between the radiator & your body. For product available in the USA/Canada market, only channel 1~11 can be operated. Selection of other channels is not possible. The antenna(s) used for this transmitter must not be co-located or operating in conjunction with any other antenna or transmitter. Shielded interface cables must be used in order to comply with emission limits.**

## Additional Information and Assistance

Contact your distributor, sales representative for technical support if you need additional assistance. Please have the following information ready before you call:

- Product name and serial number
- Description of your peripheral attachments
- Description of your software (operating system, version, application software, etc.)
- A complete description of the problem
- The exact wording of any error messages
- This equipment is a source of electromagnetic waves. Before use please, make sure that there are not EMI sensitive devices in its surrounding which may malfunction therefore.

### Environmental protection

- Follow national requirements to dispose of unit.

### Manufacturer

Avalue Technology Inc.

7F, No.87, Lide St., Zhonghe District, New Taipei City, 235, Taiwan

7F, No.95, Lide St., Zhonghe District, New Taipei City, 235, Taiwan

TEL: +886-2-8226-2345

FAX: +886-2-8226-2777

Web: [www.avaluel.com](http://www.avaluel.com)

Information: [sales@avaluel.com.tw](mailto:sales@avaluel.com.tw)

# CONTENT

<b>1. HID-2138 Multi Touch Medical Panel PC Features .....</b>	<b>14</b>
1.1 Packing List .....	14
1.2 Specifications.....	15
1.3 Front view .....	18
1.4 Rear & Bottom view .....	19
1.5 System Dimensions .....	20
<b>2. Setting Up HID-2138 Multi Touch Panel PCs .....</b>	<b>21</b>
2.1 VESA Mounting .....	22
2.2 Cabling.....	24
2.3 Cleaning and Disinfecting .....	26
<b>3. Using HID-2138 Multi Touch Panel PCs .....</b>	<b>27</b>
3.1. Turn ON/OFF the System .....	28
3.1.1 Turn ON the System .....	28
3.1.2 Turn OFF the System .....	28
3.2 Using LCD Display and Touch Screen .....	29
3.2.1 Adjust System Volume .....	29
3.2.2 Adjust LCD Display Brightness .....	29
3.2.3 LED reading light & Touch function .....	29
<b>4. HID-2138 Installation Figure.....</b>	<b>30</b>
4.1 WIFI dongle installation.....	31
4.2 Desktop Stand installation .....	32
<b>5. Hardware Configuration .....</b>	<b>33</b>
5.1 HID-2138 Overviews.....	33
5.2 HID-2138 Jumper and Connector list.....	34
5.3 HID-2138 Jumpers & Connectors settings.....	36
5.3.1 Clear CMOS (JBAT1) .....	36
5.3.2 Serial port 1/2 pin9 signal select (JRI1/JRI2) .....	36
5.3.3 LCD backlight brightness adjustment (JSBKL1) .....	37
5.3.4 AT/ATX auto power on select (JSATX1).....	37
5.3.5 LVDS Inverter connector (JBKL1).....	38
5.3.6 EDP Inverter connector (JBKL2).....	38
5.3.7 On-board header for USB2.0 (JUSB1) .....	39
5.3.8 On-board header for USB2.0 (JUSB2) .....	39
5.3.9 On-board header for USB2.0 (JUSB3) .....	40
5.3.10 Battery connector (BT1).....	40
5.3.11 LVDS connector (LVDS1).....	41

5.3.12 Speaker_R (JSPR1) .....	42
5.3.13 Speaker_L (JSPL1) .....	42
5.3.14 SPI connector (JSPI1) .....	43
5.3.15 EC Debug connector (JEC_SPI1).....	43
5.3.16 General purpose I/O connector (JDIO1) .....	44
5.3.17 Front Panel connector (JFPT1) .....	44
5.3.18 LED connector (JLED1) .....	45
5.3.19 SATA Power connector (SPWR1) .....	45
5.3.20 Serial port 1 connector (JCOM1) .....	46
5.3.21 Serial port 2 connector (JCOM2) .....	46
5.3.22 Serial port 1 in RS-422/485 mode (JRS485_1) .....	47
5.3.23 Serial port 2 in RS-422/485 mode (JRS485_2) .....	47
5.3.24 Front Audio connector (JFAUD1) .....	48
5.3.25 Line In, MIC connector (JMIC1) .....	48
5.3.26 LPC connector (JLPC1) .....	49
5.3.27 I2C EEPROM connector (JPD1).....	49
5.3.28 EDP connector (EDP1) .....	50
<b>6. General Safety Guide.....</b>	<b>51</b>
<b>7. Guidance and Manufacturer's Declaration .....</b>	<b>53</b>

# 1. HID-2138 Multi Touch Medical Panel PC

## Features

---

In this chapter, you will get to know all features of our HID-2138 Multi Touch Medical Panel PC.

### 1.1 Packing List

- 1 x HID-2138 Medical Panel PC
- 1 x Medical power adapter

#### **Power cords:**

- Utilize a UL-listed detachable power cord, 3-wire, type SJ or equivalent, 18 AWG min., rated 250 Vmin., provided with a hospital-grade type plug 5-15P configuration for 120V application, or 6-15P for 240V application.
- Do not overload wall outlets and extension cords as this may result in fire or electric shock.
- Mains lead protection (U.S.: Power cord): Power cords should be routed so that they are not likely to be walked upon or pinched by items placed upon or against them, paying particular attention to cords at plugs and receptacles.
- The power supply cord should be replaced by the designated operator only at all time.
- Use a power cord that matches the voltage of the power outlet, which has been approved and complies with the safety standard of your particular country.

## 1.2 Specifications

Component	
<b>Mother Board</b>	HID TGLP Mother Board
<b>CPU</b>	Onboard Intel® 11th gen Core™ i7/i5/i3/Celeron Processor
<b>Daughter Board</b>	Optional low profile PCIE Board
<b>CPU Cooler (Type)</b>	Heat pipe
<b>Memory</b>	Two 260-pin DDR4 3200 MHz SO-DIMM socket, supports up to 64GB Max (non ECC only) (ACC-MEM-8G-32R, ACC-MEM-16G-19R)
<b>Power Supply</b>	DC in
<b>Adapter</b>	EDAC EM11013C 19V 90W Screw Type Medical Adapter
<b>System Fan</b>	Fan-less
<b>Microphone</b>	Optional
<b>Speaker</b>	2W x 2
<b>Camera</b>	5.0MP Auto Focus WebCam with external cover (optional) ACC-NBCAM-08R
<b>Wireless LAN</b>	Optional Wi-Fi + Bluetooth 5.0 USB Module (USB2.0)
<b>Operating System</b>	Win10 64bit, Linux (Ubuntu 21.04.0/Kernel 5.8)
<b>Expansion Card</b>	Optional PCIE low profile card x 1 M.2 storage x 1 M.2 5G Module x 1
<b>Other Component</b>	NFC Module JunWei NFC Module CT-NFC-A172-02
	Dual LED Reading Light Bar
Storage	
<b>Solid State Drive</b>	Onboard SATA connector and SATA Power
Panel	
<b>LCD Panel</b>	AUO G215HAN01.3/ 1.5
<b>LED Driving Board</b>	DB-LDA001-4-060
<b>Touch Screen</b>	21.5 PCAP
<b>Touch Controller</b>	EETI EXC84H5680STAG
External I/O	
<b>Serial Port</b>	Optional COM port x 1—RS232/422/485 selected by BIOS
<b>External USB Port</b>	USB 2.0 x 2 USB type C x 2 (USB 3.1/Display/PD 3.0)

<b>Audio Port</b>	Line-Out + Mic-in (Combo jack)
<b>LAN Port</b>	RJ 45 x 2 (i219 x 1 , i226 x 1)
<b>Indicator Light</b>	HDD LED, Power LED
<b>Expansion Slots</b>	M.2 Key-B 2242/3042/2260 x 1 for storage PCIE low profile x 1
<b>Mechanical</b>	
<b>Power Type</b>	DC Input 24V
<b>Power Connector Type</b>	Lockable DC jack
<b>Power Mode</b>	AT/ATX (ATX is default setting)
<b>Dimension</b>	539.6 x 342.6 x 45.4mm
<b>Weight</b>	6.0 kg
<b>Color</b>	White Plastic
<b>Fanless</b>	Yes
<b>Reliability</b>	
<b>EMI Test</b>	CE : IEC/EN60601-1-2 FCC : Part 15 Class B
<b>Safety</b>	UL60601-1
<b>Vibration Test</b>	<p>Random Vibration Operation</p> <p>Reference IEC60068-2-64 Testing procedures</p> <p>Test Fh : Vibration broadband random Test</p> <p>1 Test PSD : 0.00454G<sup>2</sup>/Hz , 1.5 Grms</p> <p>2 Test frequency : 5~500 Hz</p> <p>3 Test axis : X,Y and Z axis</p> <p>4 Test time : 30 minutes each axis</p> <p>5 System condition : operation mode</p> <p>6 Test curve</p> <p>Sine Vibration Test</p> <p>Reference IEC60068-2-6 Testing procedures</p> <p>Test Fc : Vibration sinusoidal</p> <p>1 Test Acceleration : 2G</p> <p>2 Test frequency : 5~500 Hz</p> <p>3 Sweep : 1 Oct/ per one minute. (logarithmic)</p> <p>4 Test axis : X,Y and Z axis</p> <p>5 Test time :30 min. each axis</p> <p>6 System condition : Non-Operating mode</p> <p>7 Test curve</p>



	<p>Package Vibration Test:</p> <p>Reference IEC60068-2-64 Testing procedures</p> <p>Test Fh : Vibration boardband random Test</p> <p>1 Test PSD : 0.026G<sup>2</sup>/Hz , 2.16 Grms</p> <p>2 Test frequency : 5~500 Hz</p> <p>3 Test axis : X,Y and Z axis</p> <p>4 Test time : 30 minutes each axis</p> <p>5 Test curve</p>
<b>Mechanical Shock Test</b>	With CF/SSD: 10Grms, IEC 60068-2-27, Half Sine, 11ms
<b>Drop Test</b>	<p>Package drop test</p> <p>Reference ISTA 2A, Method : IEC-60068-2-32 Test:Ed</p> <p>Test Ea : Drop Test</p> <p>1 Test phase : One corner, three edges, six faces</p> <p>2 Test high :</p> <p>3 Package weight :</p> <p>4 Test drawing</p>
<b>Operating Temperature</b>	0°C ~ 40°C (32°F ~ 104°F)
<b>Storage &amp; Transportation Condition (in range of °C and % R.H.)</b>	-20°C ~ 60°C, 10% ~ 95%
<b>Atmospheric Pressure</b>	700~1060hPa
<b>Expected Service Life</b>	43368 Hrs
<b>Operating Humidity</b>	40°C @ 95% Relative Humidity, Non-condensing



**Note:** Specifications are subject to change without notice.

### 1.3 Front view

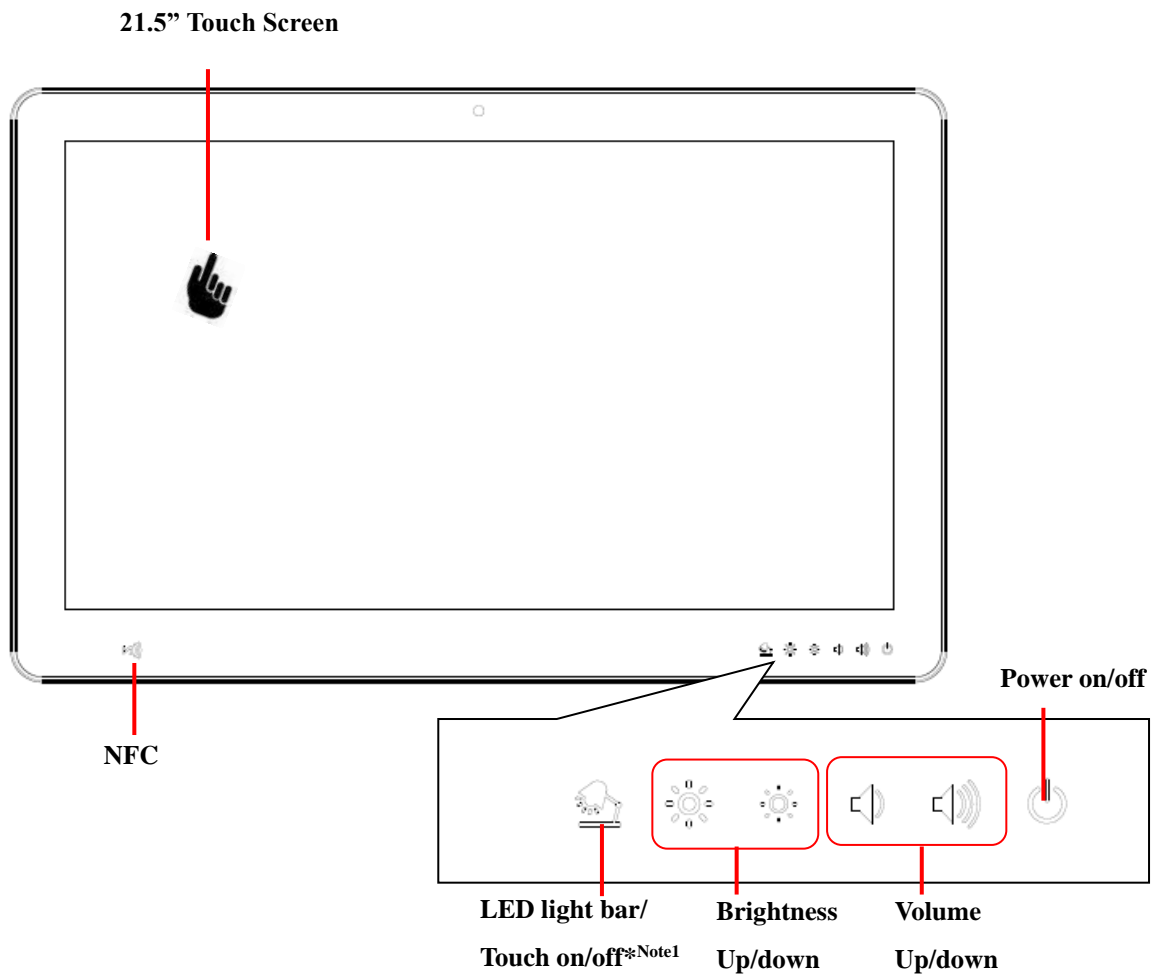

Note1:

Press this button for 2 sec to turn on or off LED reading light bar

Press this button for 4 sec to turn off or on for touch function

## 1.4 Rear & Bottom view

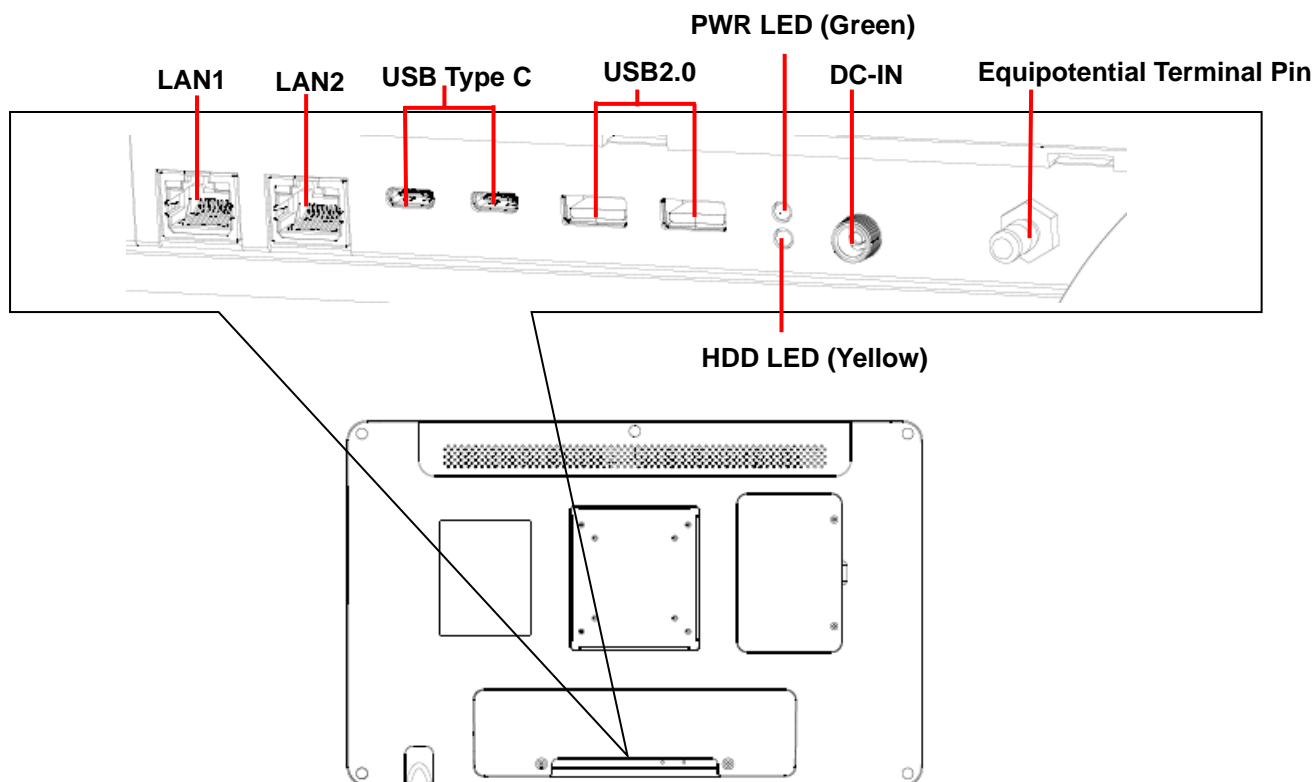

I/O port functions description:

Equipotential Terminal Pin: for connect hospital ground/earth

DC in: for Power adapter DC jack

HDD LED: indicate HDD activities status

PWR LED: indicate power status

USB2.0: USB 2.0 x 2

USB Type C: USB type C x 2 (Output for USB 3.1 & Display, Input for PD 3.0 15V)

LAN: for internet connection

**Note!** Equipotential terminal needs to be linked to the hospital ground/earth system before booting the system to protect both operator and system.



## 1.5 System Dimensions

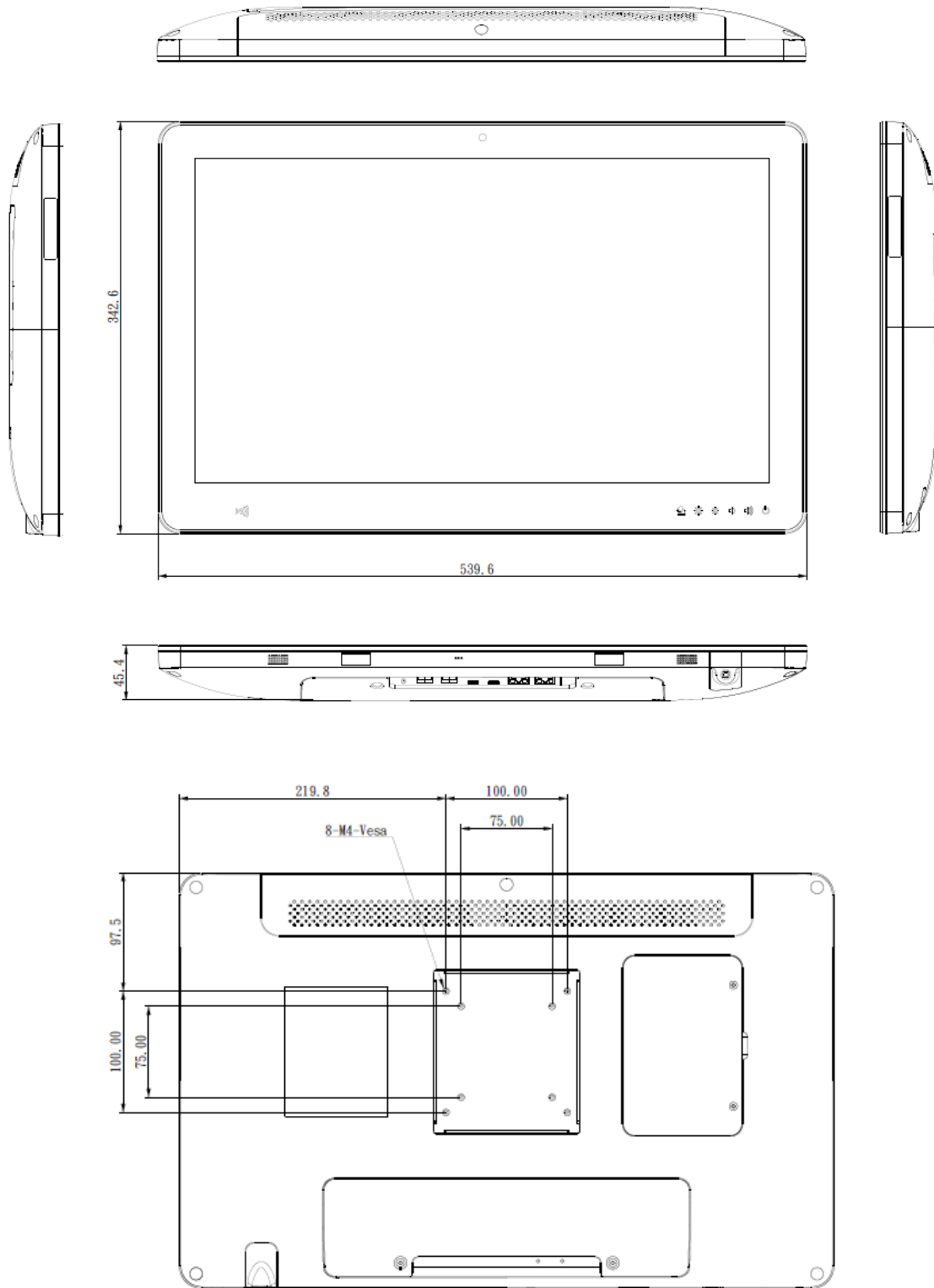

Unit: mm

## **2. Setting Up HID-2138 Multi Touch Panel PCs**

---

This chapter gives instructions on how to set up HID-2138 Multi Touch Panel PC and how to connect different cables.

2.1 VESA Mounting

2.2 Cleaning and Disinfecting

## 2.1 VESA Mounting

The HID-2138 also provides standard VESA mounting to help system integrators conveniently integrate the panel PC into their system.

Never use mounting brackets except as provided by Avalue to prevent unreliable mounting of the HID-2138. VESA mount installation should be carried out by a professional technician; please contact a service technician or your retailer if you need this service.

Installation instructions follow:

1. First attach the wall-mounting to the heat-sink of the HID-2138, securing it in place with four of the M4 x 6mm screws provided.
2. Mount the on the wall, stand or other flat surface.

**Warning!** *Be sure to secure the screws of the mounting bracket tightly. A loose joint between the HID-2138 and mounting bracket may create danger of injury.*

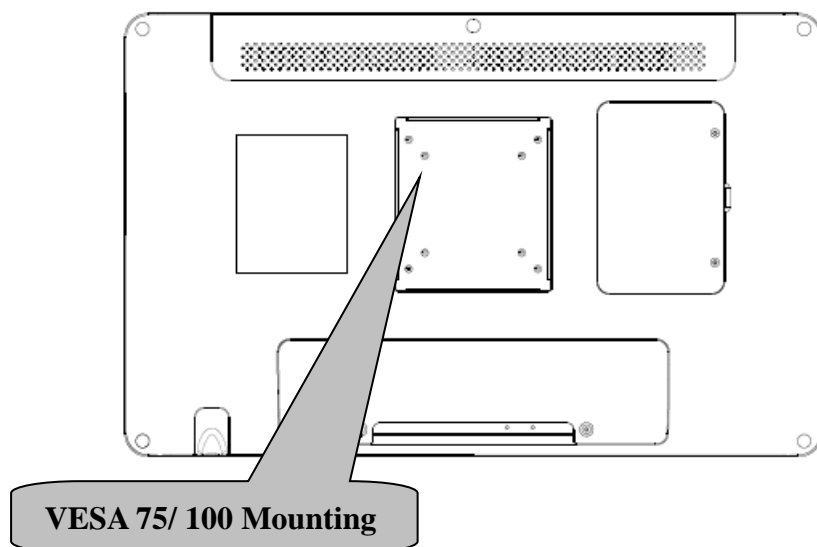

Suggested Screw type for mounting

**Note:** 4 pieces of M4 x 6mm screws (P/N: E1933050611R)

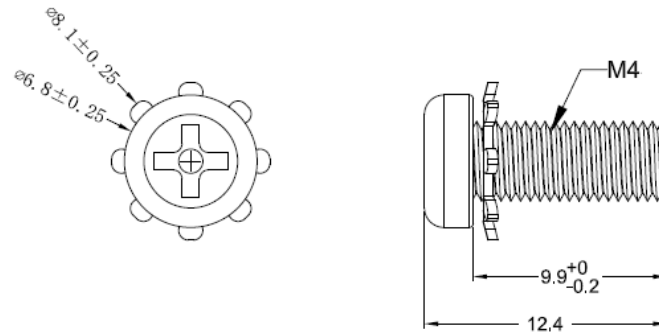

**Warning!** Use suitable mounting apparatus to avoid risk of injury.



## 2.2 Cabling

1. Power Cable
2. Equipotential Terminal Pin

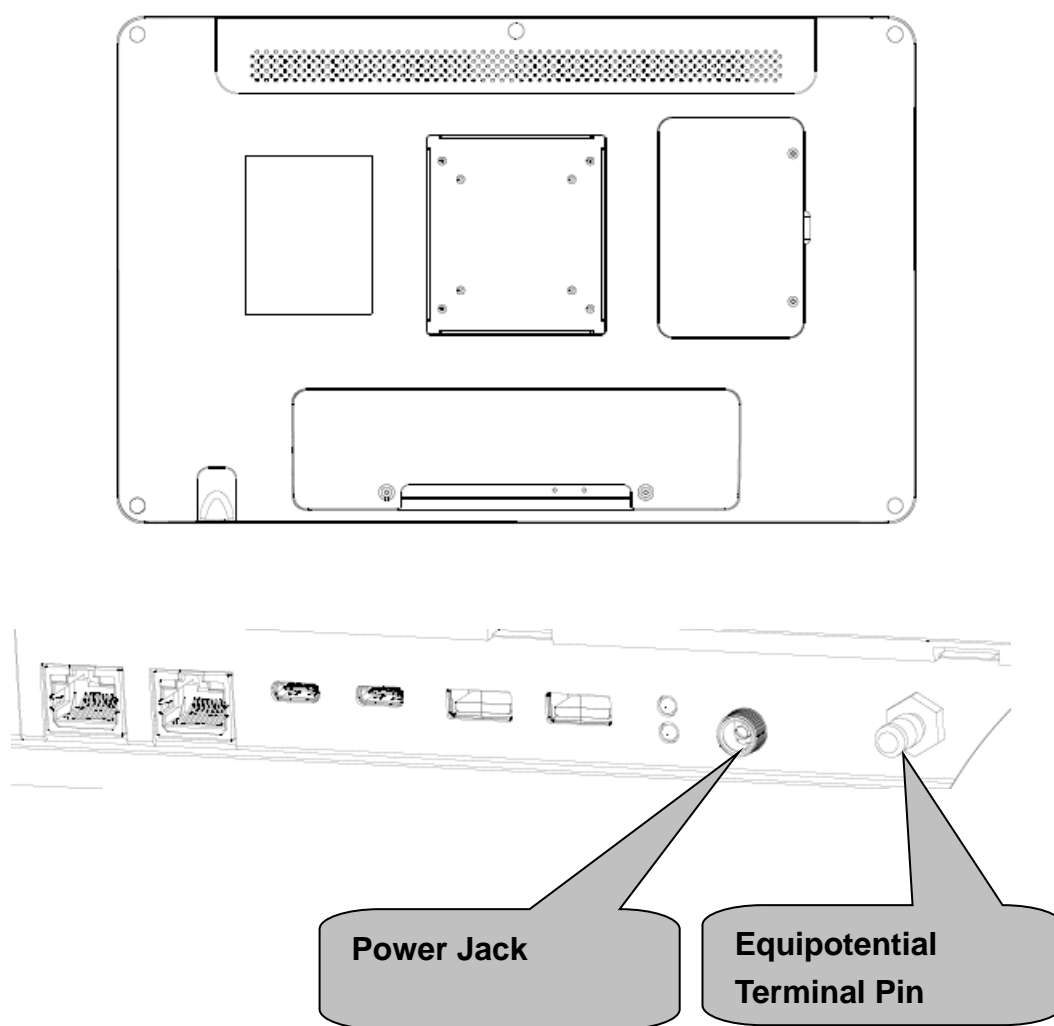

Follow below step Connecting the Ground pin

1. With system ready, find the equipotential terminal on the rear side of the HID-2138. An equipotential terminal is provided to optionally connect to a hospital ground/earth system.
2. Prepare grounding cable and the other terminal links to the hospital ground/earth system.
3. Grounding cable plug with Equipotential Terminal



Please follow below steps to connect power cable to system.

The HID-2138 could only be powered by a DC power adapter (EDAC Model no. EM11013C). Be sure to always handle the power cords by holding the plug ends only.

Follow these procedures in order:

1. Connect the female end of the power adapter to the DC jack of the panel PC.
2. Connect the female end of the power cord to the DC power adapter.
3. Connect the 3-pin male plug of the power cord to an electrical outlet.

External equipment intended for connection to signal input/output or other connectors, shall comply with relevant UL standards (e.g. UL 60950-1 for IT equipment and ANSI/AAMI ES60601-1/ IEC 60601-1 series for medical electrical equipment)



## WARNING



RISK OF ELECTRIC SHOCK

- TO REDUCE THE RISK OF ELECTRIC SHOCK, DO NOT REMOVE FRONT OR BACK COVER.
- READ THE MANUAL AND SAFETY PRECAUTIONS BEFORE PERFORMING INSTALLATION.
- MAKE SURE THE POWER CORD IS PLUGGED INTO THE SYSTEM BEFORE CONNECTING THE POWER CORD TO AN AC POWER OUTLET.
- DISCONNECT POWER FROM THE SYSTEM BY UNPLUGGING THE POWER CORD FROM AC OUTLET.
- THE AC POWER OUTLET SHOULD BE COMPATIBLE WITH THE 3-PIN POWER CORD CONNECTOR.

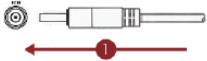

1. Plug the power cord into your system



2. Connect AC power cord to the power adapter.

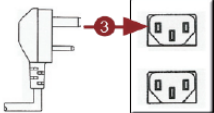

3. Plug the power cord into an easily accessible AC power outlet.

## 2.3 Cleaning and Disinfecting

During normal use of HID-2138, the device may become dirty and should be regularly cleaned.

### Cleaning Instructions

1. Turn off the computer before starting clean up. This way, you can see any dirt on the screen; the brightness of the monitor may make you miss some areas.
2. Wet a soft, lint-free or microfiber cloth with cleaning agent per manufacturer's instructions or hospital protocol. Wipe the medical PC in a gentle motion to remove dust, oil, or fingerprint smudges.
3. Wipe any moisture excess with a dry lint-free cloth to finish cleaning before turning the computer back on.

### Cleaning Tools

Below is a list of some items that may be needed or used when cleaning the medical PC or medical PC peripherals.

Please keep in mind that some components in medical PC components may only be cleaned using a product designed for cleaning that component.

Cleaning agent list: chemical disinfectants which have been tested on the medical PC

#### No. Cleaning agent

1. Water
2. Alcohol
3. Alcohol 75%

#### Caution!



- *Do not immerse or rinse the HID-2138 or its peripherals. If you accidentally spill liquid on the device, disconnect the unit from the power source. Contact your Biomed Department regarding the continued safety of the unit before placing it back in operation.*
- *Do not spray cleaning agent on the chassis.*
- *Do not use disinfectants that contain phenol. Do not autoclave or clean the HID-2138 or its peripherals with strong aromatic, chlorinated, ketone, ether, or Esther solvents, sharp tools or abrasives. Never immerse electrical connectors in water or other liquids.*

## **3. Using HID-2138 Multi Touch Panel PCs**

---

This chapter describes in detail all features of HID-2138 Multi Touch Panel PC.

3.1 Turn ON/OFF the System

3.2 Using LCD Display and Touch Screen

### 3.1. Turn ON/OFF the System

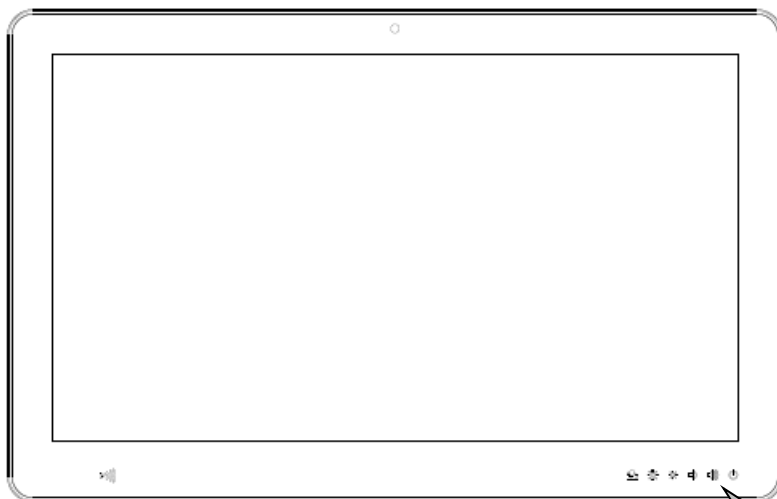

**ON/OFF Touch Button**

#### 3.1.1 Turn ON the System

1. Check if the Power ON/OFF LED light is Orange.
2. Press the Power ON/OFF icon firmly to turn power ON
3. The Power ON/OFF LED will turn green to indicate power is on.

#### 3.1.2 Turn OFF the System

1. Press on the Power ON/OFF icon firmly for 4 seconds.
2. The Power ON/OFF LED will turns orange to indicate power is off.
3. Your system is turned OFF.

**Note:** We recommend using operating system shut down procedure to turn the system OFF.

## 3.2 Using LCD Display and Touch Screen

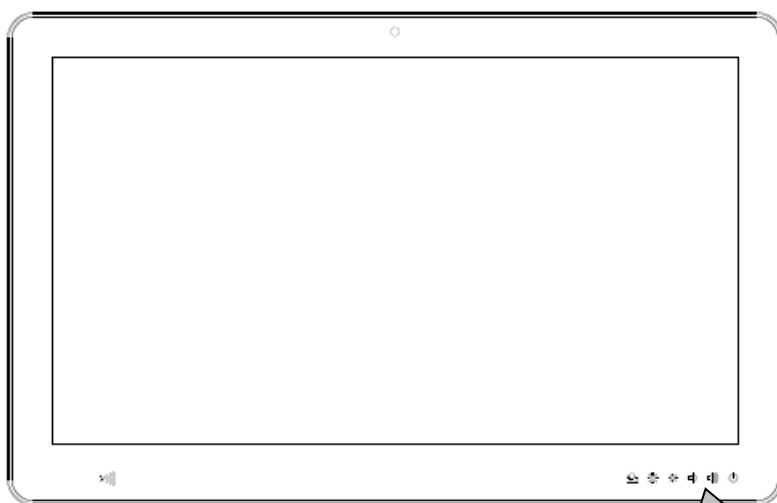

### 3.2.1 Adjust System Volume

1. Press the Volume Up or Volume Down icon to increase or decrease volume
2. The volume will be adjusted accordingly.

### 3.2.2 Adjust LCD Display Brightness

1. Press the Brightness Up or Brightness Down icon to increase or decrease brightness.
2. The brightness of the LCD display will be adjusted accordingly.

### 3.2.3 LED reading light & Touch function

1. Press LED reading light icon for 2 sec to turn on the light bar.
2. Press LED reading light icon for 2 sec to turn off the light bar
3. Press LED reading light icon for 4 secs to turn off the touch function (touch function always on as default)
4. Press LED reading light icon for 4 secs to turn on the touch function

## 4. HID-2138 Installation Figure

---

In this chapter, you will learn how to install storage into HID-2138. Please perform these steps with care.

▲ **WARNING:** Turn OFF the system and disconnect the power cable before performing the following tasks.

▲ **CAUTION:** Only a certified service technician is authorized to remove the cover and access system components.

## 4.1 WIFI dongle installation

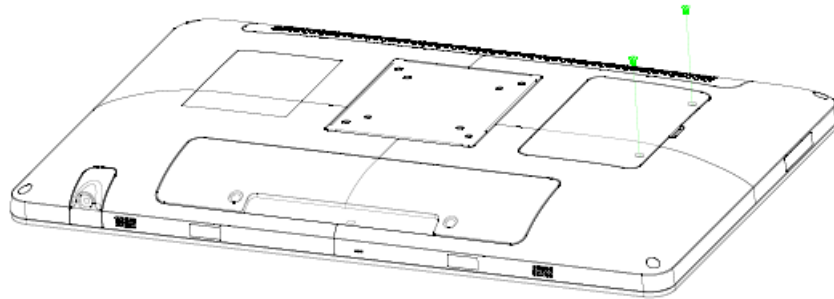

**Step1.** Remove 2 screws to release the chassis cover, and remove it.

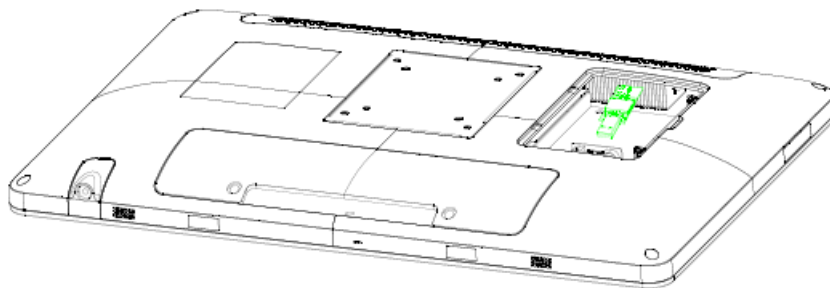

**Step2.** Insert the WIFI dongle.

## 4.2 Desktop Stand installation

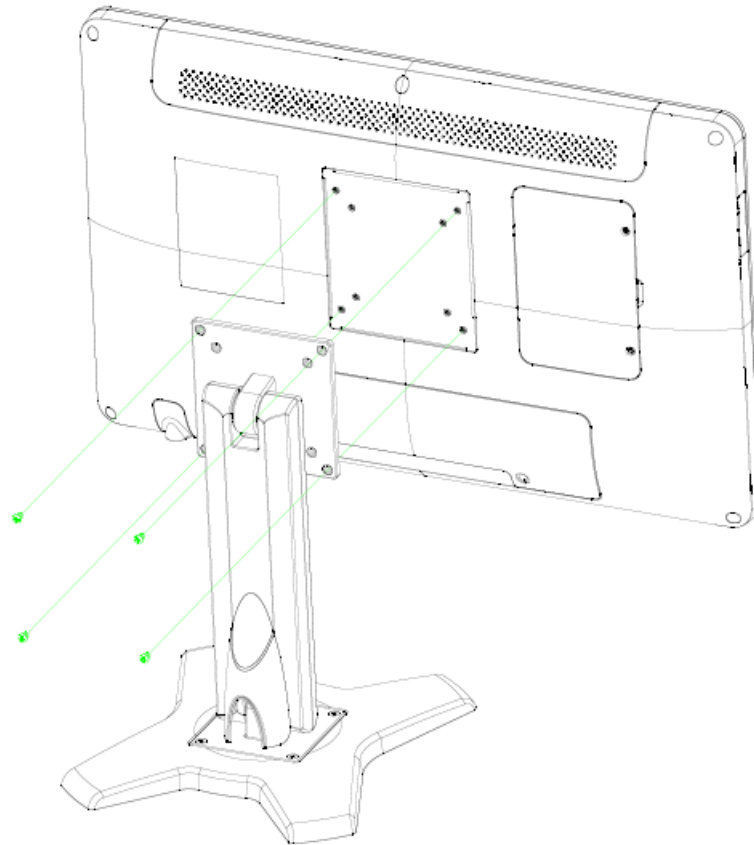

**Step1.** Position VESA Mount on both sides, matching the holes on the system.

**Step2.** Insert and fasten 4 screws on each side of the monitor to secure Mounting brackets.



## 5. Hardware Configuration

### 5.1 HID-2138 Overviews

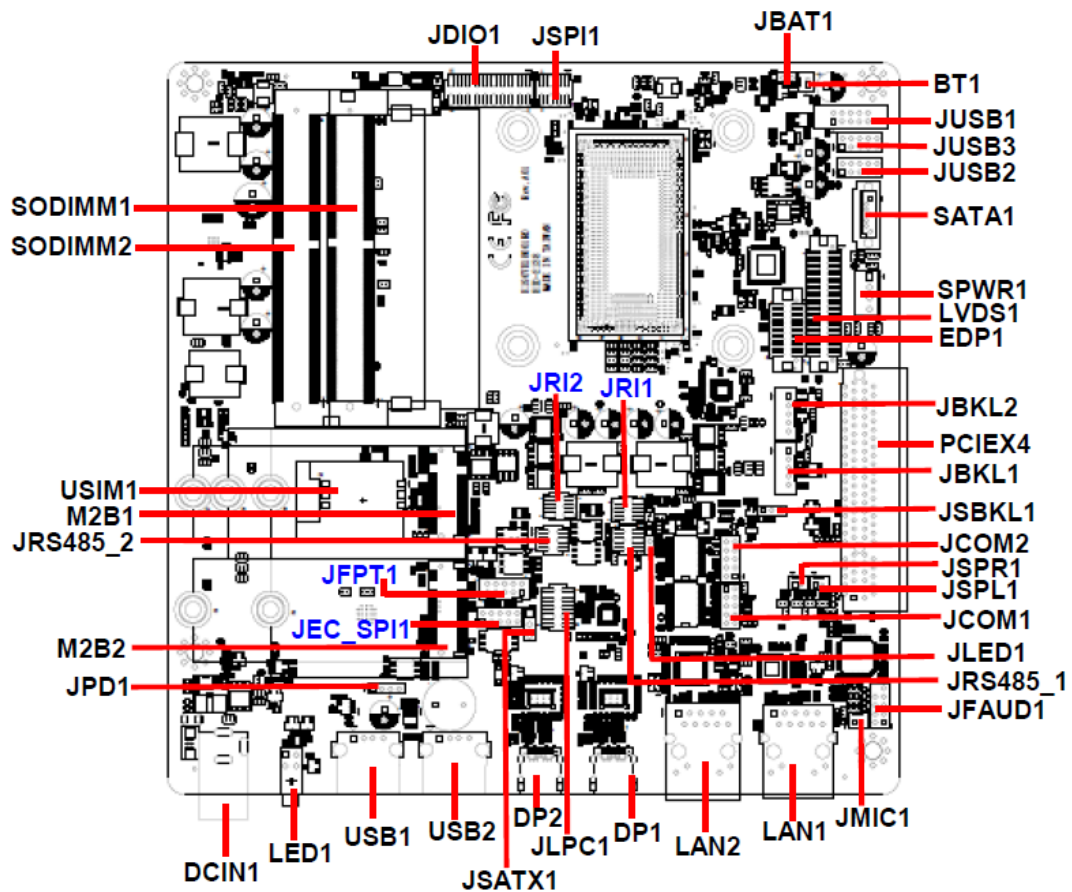

## 5.2 HID-2138 Jumper and Connector list

### Jumpers

Label	Function	Note
<b>JBAT1</b>	Clear CMOS	3 x 1 header, pitch 2.00mm
<b>JRI1/2</b>	Serial port 1/2 pin9 signal select	3 x 2 header, pitch 2.00mm
<b>JSBKL1</b>	LCD backlight brightness adjustment	3 x 1 header, pitch 2.00mm
<b>JSATX1</b>	AT/ATX auto power on select	3 x 1 header, pitch 2.54mm

### Connectors

Label	Function	Note
<b>SODIMM1/2</b>	2 x 260-Pin DDR4 3200MHz SO-DIMM	
<b>JBKL1</b>	LVDS Inverter connector	5 x 1 wafer, pitch 2.00mm
<b>JBKL2</b>	EDP Inverter connector	5 x 1 wafer, pitch 2.00mm
<b>COM1/2</b>	Serial port 1/2 connector	D-sub 9 pin, male
<b>JSPR1</b>	Speaker_R	2 x 1 wafer, pitch 2.00mm
<b>JSPL1</b>	Speaker_L	2 x 1 wafer, pitch 2.00mm
<b>EDP1</b>	EDP connector	2 x 10 wafer, pitch 1.25mm
<b>JCOM1</b>	Serial port 1 connector	5 x 2 header, pitch 2.00mm
<b>JCOM2</b>	Serial port 2 connector	5 x 2 header, pitch 2.00mm
<b>JRS485_1</b>	Serial port 1 in RS-422/485 mode	3 x 2 header, pitch 2.00mm
<b>JRS485_2</b>	Serial port 2 in RS-422/485 mode	3 x 2 header, pitch 2.00mm
<b>LED1</b>	HDD/Power LED indicator	
<b>JLED1</b>	LED connector	3 x 1 header, pitch 2.00mm
<b>JFAUD1</b>	Front Audio connector	5 x 2 header, pitch 2.00mm
<b>LVDS1</b>	LVDS connector	DIN 40-pin wafer, pitch 1.25mm
<b>USB1/2</b>	2 x USB2.0 connector	
<b>JUSB1</b>	On-board header for USB2.0	5 x 2 wafer, pitch 2.00mm
<b>JUSB2</b>	On-board header for USB2.0	5 x 2 header, pitch 2.00mm
<b>JUSB3</b>	On-board header for USB2.0	5 x 2 header, pitch 2.00mm
<b>LAN1/2</b>	RJ-45 Ethernet 1/2	

<b>PCIEX4</b>	PCIex4 connector	
<b>BT1</b>	Battery connector	2 x 1 wafer, pitch 1.25mm
<b>JDIO1</b>	General purpose I/O connector	10 x 2 header, pitch 2.00mm
<b>JMIC1</b>	Line In, MIC connector	Line In, MIC connector
<b>JSPI1</b>	SPI connector	4 x 2 header, pitch 2.00mm
<b>JEC_SPI1</b>	EC Debug connector	5 x 2 header, pitch 2.00mm
<b>SATA1</b>	Serial ATA connector	
<b>SPWR1</b>	SATA Power connector	4 x 1 wafer, pitch 2.54mm
<b>JFPT1</b>	Front Panel connector	5 x 2 wafer, pitch 2.00mm
<b>DP1/2</b>	2 x USB type C connector	
<b>DCIN1</b>	DC-IN connector	
<b>JLPC1</b>	LPC connector	5 x 2 header, pitch 2.00mm
<b>JPD1</b>	I2C EEPROM connector	4 x 1 header, pitch 2.00mm
<b>M2B1</b>	M.2 KEY-B1 connector	
<b>M2B2</b>	M.2 KEY-B2 connector	
<b>USIM1</b>	SIM card slot	

## 5.3 HID-2138 Jumpers & Connectors settings

### 5.3.1 Clear CMOS (JBAT1)

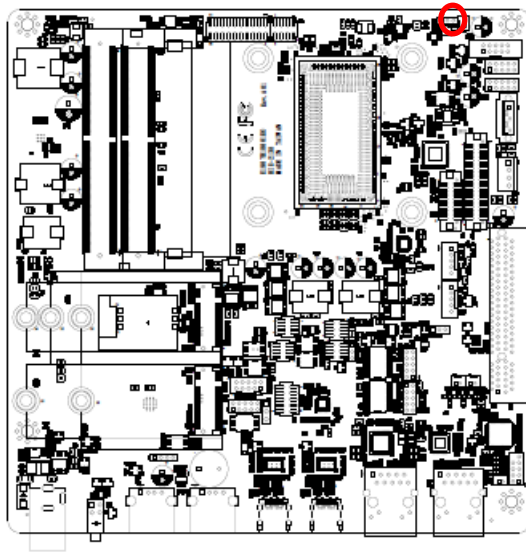

Protect\*

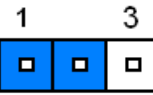

Clear CMOS

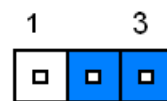

\*Default

### 5.3.2 Serial port 1/2 pin9 signal select (JRI1/JRI2)

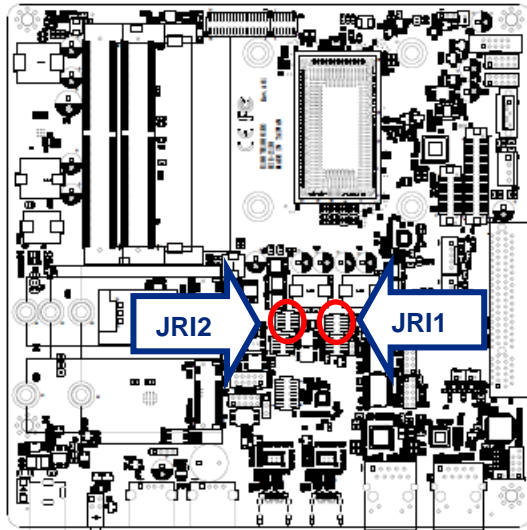

Ring\*

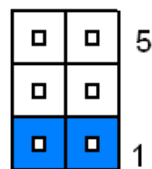

+5V

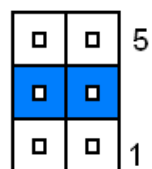

+12V

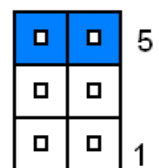

\* Default

### 5.3.3 LCD backlight brightness adjustment (JSBKL1)

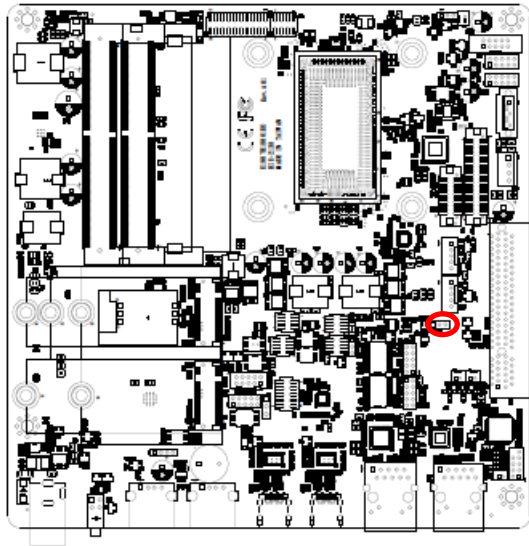

#### PWM Mode\*

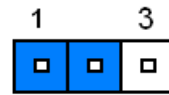

#### DC Mode

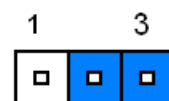

\* Default

### 5.3.4 AT/ATX auto power on select (JSATX1)

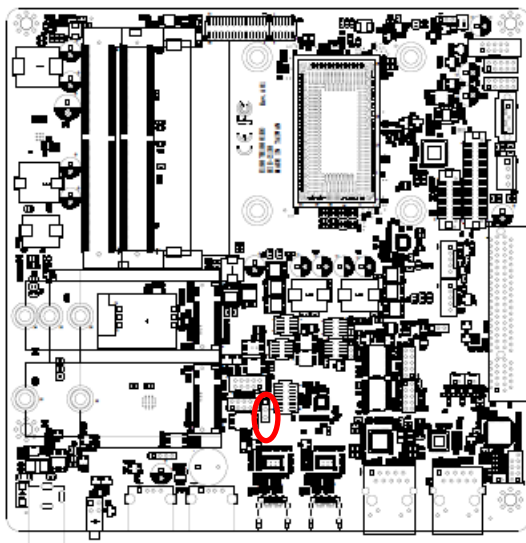

#### ATX\*

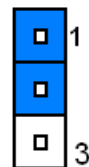

#### AT

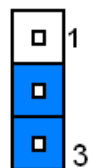

\* Default

### 5.3.5 LVDS Inverter connector (JBKL1)

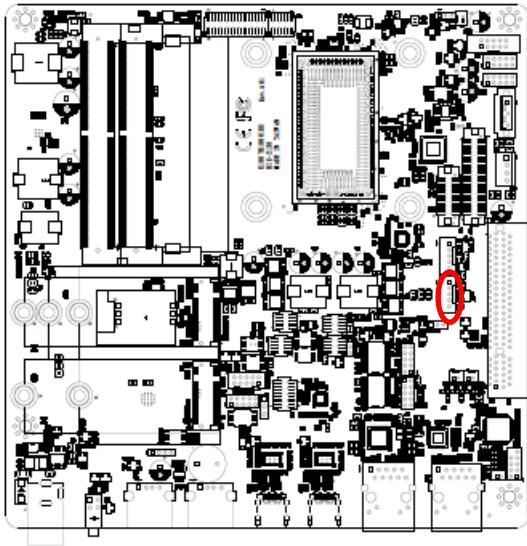

Signal	PIN
+12V	1
GND	2
LVDS_BKLT_EN	3
LVDS_BKLT_CTL	4
+5V	5

### 5.3.6 EDP Inverter connector (JBKL2)

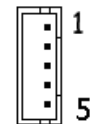
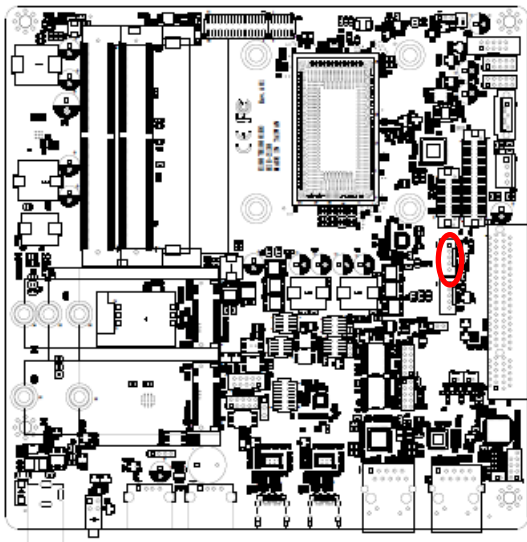

Signal	PIN
+12V	1
GND	2
EDP2_BKLTEN	3
EDP2_BKLT_CTL	4
+5V	5

### 5.3.7 On-board header for USB2.0 (JUSB1)

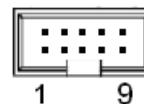
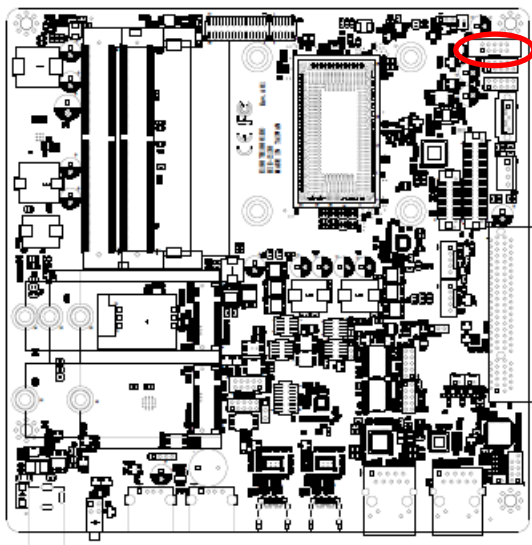

Signal	PIN	PIN	Signal
+5VSB	1	2	USB3_R_RXN3
USB2_R_DN3	3	4	USB3_R_RXP3
USB2_R_DP3	5	6	GND
GND	7	8	USB3_R_TXN3
GND	9	10	USB3_R_TXP3

### 5.3.8 On-board header for USB2.0 (JUSB2)

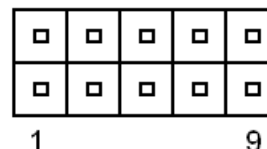
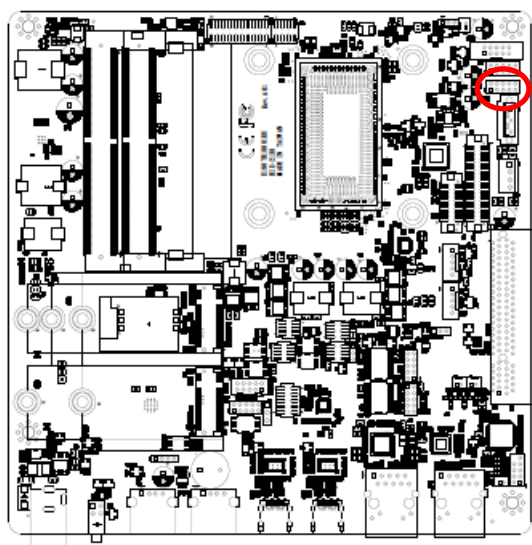

Signal	PIN	PIN	Signal
+5VSB	1	2	+5VSB
USB2_R_DN5	3	4	USB2_R_DN6
USB2_R_DP5	5	6	USB2_R_DP6
GND	7	8	GND
GND	9	10	GND

### 5.3.9 On-board header for USB2.0 (JUSB3)

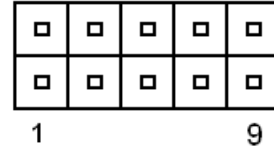
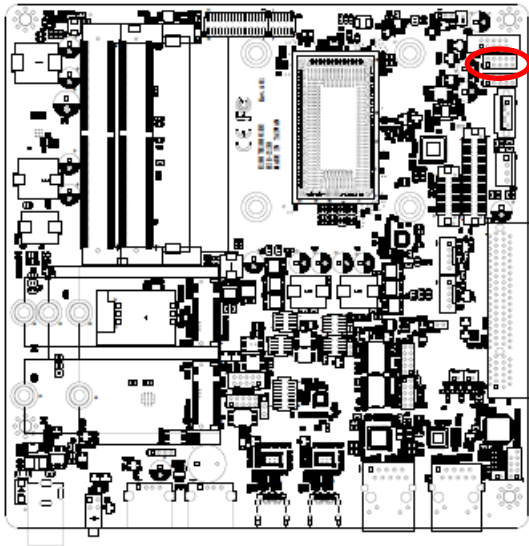

Signal	PIN	PIN	Signal
+5VSB	1	2	+5VSB
USB2_R_DN8	3	4	USB2_R_DN7
USB2_R_DP8	5	6	USB2_R_DP7
GND	7	8	GND
GND	9	10	GND

### 5.3.10 Battery connector (BT1)

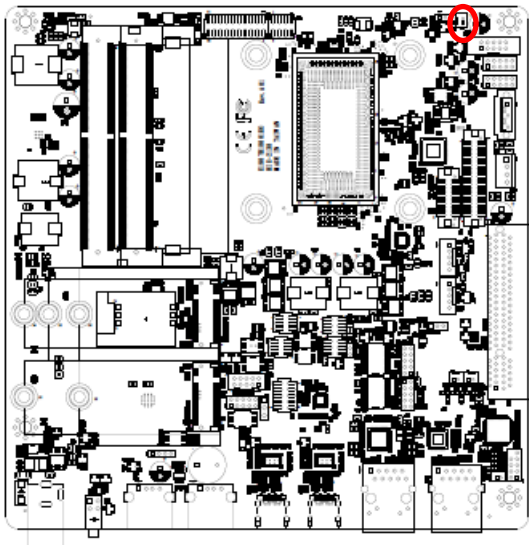

Signal	PIN
GND	2
+RTCBATT	1



### 5.3.11 LVDS connector (LVDS1)

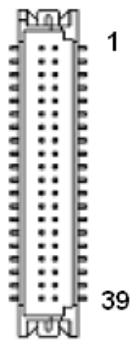
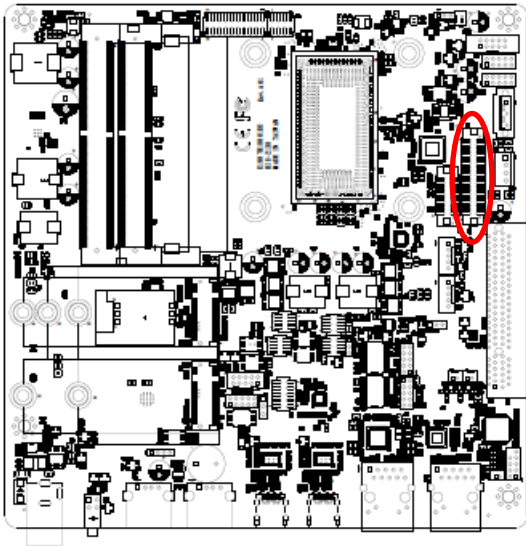

Signal	PIN	PIN	Signal
+5V	2	1	+3.3V
+5V	4	3	+3.3V
NC	6	5	NC
GND	8	7	GND
LVDS_DATA0_P	10	9	LVDS_DATA1_P
LVDS_DATA0_N	12	11	LVDS_DATA1_N
GND	14	13	GND
LVDS_DATA2_P	16	15	LVDS_DATA3_P
LVDS_DATA2_N	18	17	LVDS_DATA3_N
GND	20	19	GND
LVDS_DATA4_P	22	21	LVDS_DATA5_P
LVDS_DATA4_N	24	23	LVDS_DATA5_N
GND	26	25	GND
LVDS_DATA6_P	28	27	LVDS_DATA7_P
LVDS_DATA6_N	30	29	LVDS_DATA7_N
GND	32	31	GND
LVDS_CLK1_P	34	33	LVDS_CLK2_P
LVDS_CLK1_N	36	35	LVDS_CLK2_N
GND	38	37	GND
+12V	40	39	+12V

### 5.3.12 Speaker\_R (JSPR1)

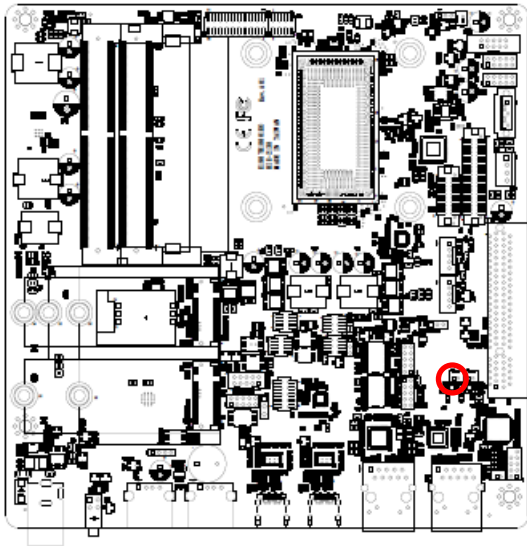

1

Signal	PIN
SPK_R+	1
SPK_R-	2

### 5.3.13 Speaker\_L (JSPL1)

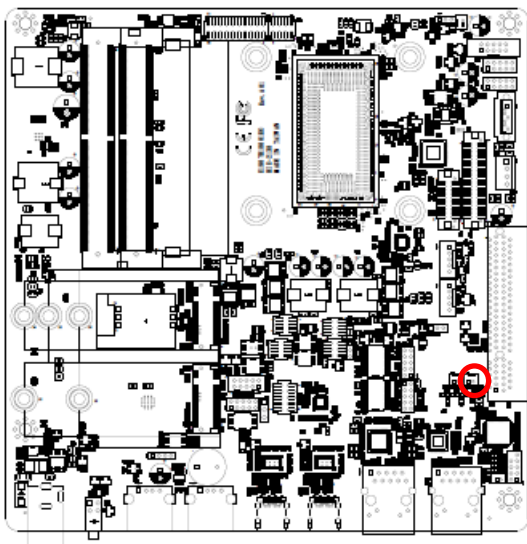

1

Signal	PIN
SPK_L+	1
SPK_L-	2

### 5.3.14 SPI connector (JSPI1)

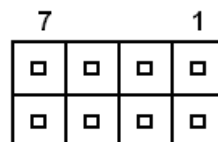
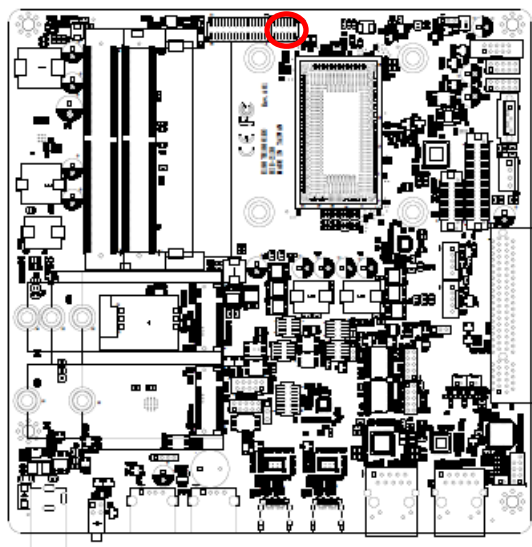

Signal	PIN	PIN	Signal
+3.3VSB	1	2	GND
SPI0_CS0#	3	4	SPI0_BIOS_CLK
SPI0_BIOS_MISO	5	6	SPI0_BIOS_MOSI
BIOS_HOLD#	7	8	BIOS_WP#

### 5.3.15 EC Debug connector (JEC\_SPI1)

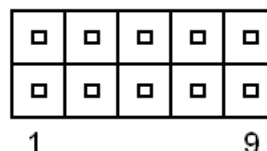
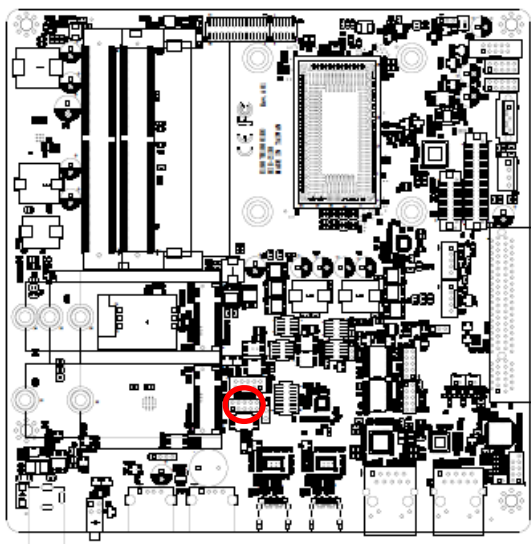

Signal	PIN	PIN	Signal
+3.3VSB	1	2	GND
EC_FSCE#	3	4	EC_FSCK
EC_FMISO	5	6	EC_FMOSI
EC_HOLD#	7	8	NC
EC_SMCLK_DEBUG	9	10	EC_SMDAT_DEBUG

### 5.3.16 General purpose I/O connector (JDIO1)

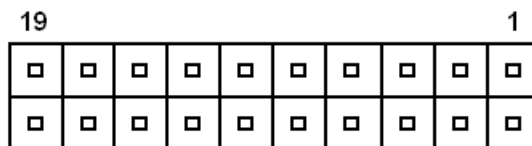
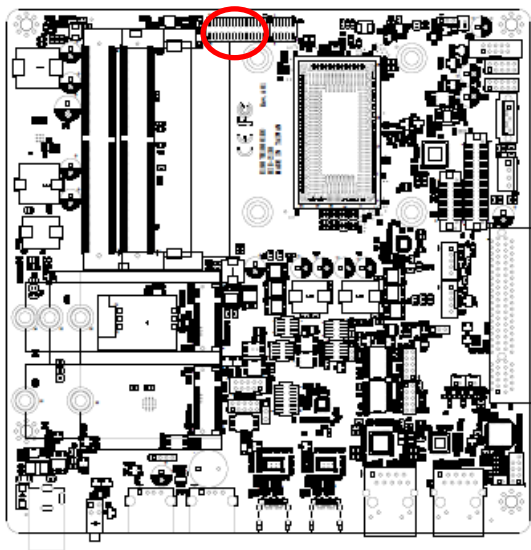

Signal	PIN	PIN	Signal
D10	1	2	DO0
D11	3	4	DO1
D12	5	6	DO2
D13	7	8	DO3
D14	9	10	DO4
D15	11	12	DO5
D16	13	14	DO6
D17	15	16	DO7
SMB_SCL_S0 _3P3EXT	17	18	SMB_SDA_S0 _3P3EXT
GND	19	20	+5V

### 5.3.17 Front Panel connector (JFPT1)

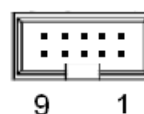
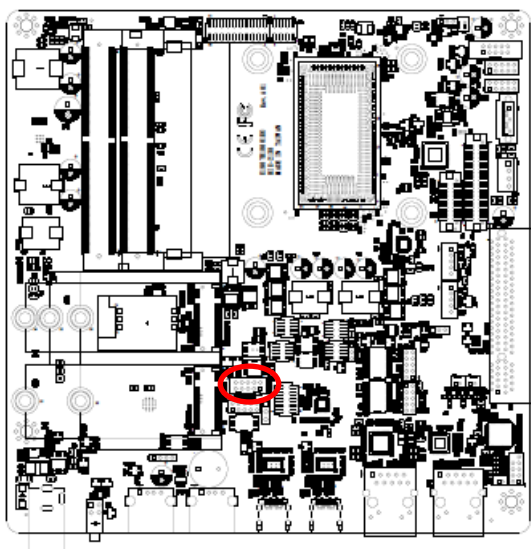

Signal	PIN	PIN	Signal
GND	1	2	+V3.3A_EC
BTN_VOL_UP#	3	4	BTN_VOL_DN#
BTN_BRI_DN#	5	6	BTN_BRI_UP#
TOUCH_PWRBTN#	7	8	LED_BOARD_ONOFF#
FP_LED1	9	10	FP_LED2

### 5.3.18 LED connector (JLED1)

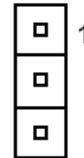
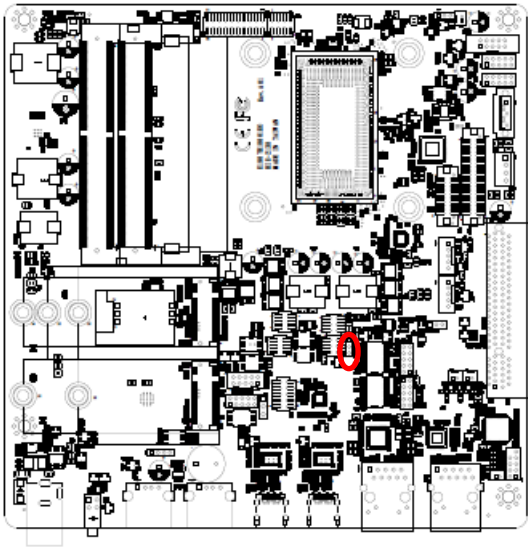

Signal	PIN
+5VSB	1
Reading_LED_EN	2
GND	3

### 5.3.19 SATA Power connector (SPWR1)

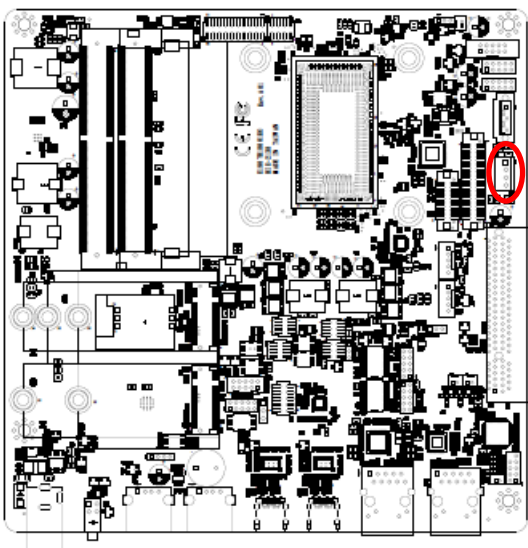

Signal	PIN
+5V	1
GND	2
GND	3
+12V	4

### 5.3.20 Serial port 1 connector (JCOM1)

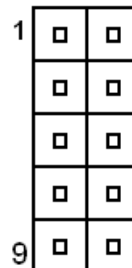
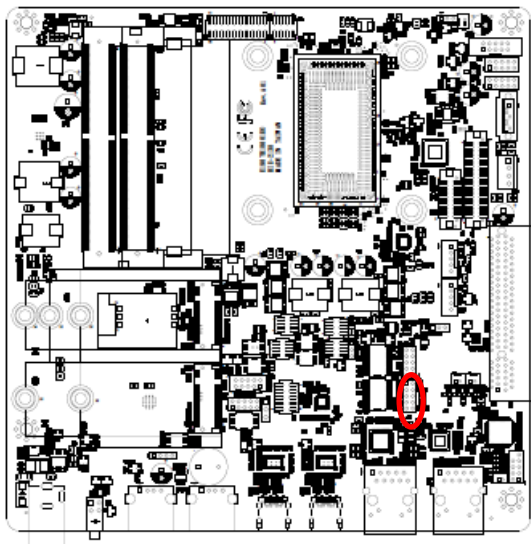

Signal	PIN	PIN	Signal
COM_DCD#_1	1	2	COM_RXD_1
COM_TXD_1	3	4	COM_DTR#_1
GND	5	6	COM_DSR#_1
COM_RTS#_1	7	8	COM_CTS#_1
COM_RI#_1	9	10	NC

### 5.3.21 Serial port 2 connector (JCOM2)

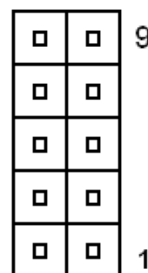
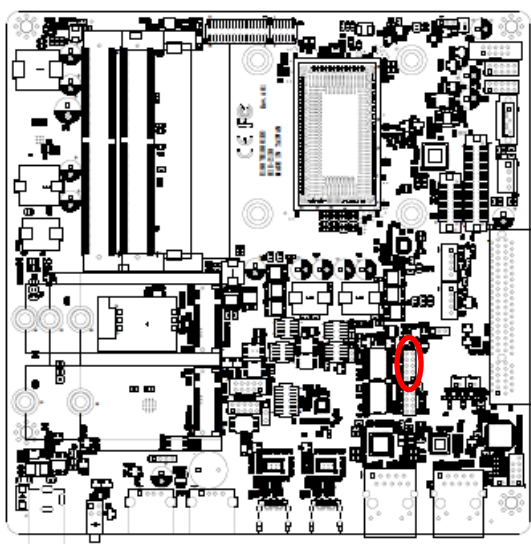

Signal	PIN	PIN	Signal
NC	10	9	COM_RI#_2
COM_CTS#_2	8	7	COM_RTS#_2
COM_DSR#_2	6	5	GND
COM_DTR#_2	4	3	COM_TXD_2
COM_RXD_2	2	1	COM_DCD#_2

### 5.3.22 Serial port 1 in RS-422/485 mode (JRS485\_1)

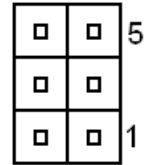
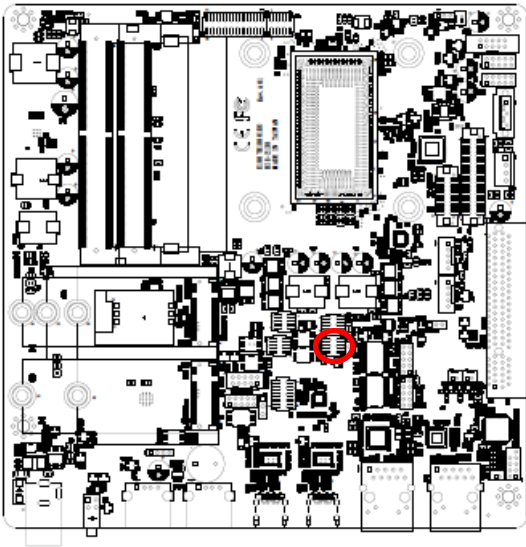

Signal	PIN	PIN	Signal
GND	6	5	+5V
422RX1+	4	3	485_422TX1+
422RX1-	2	1	485_422TX1-

### 5.3.23 Serial port 2 in RS-422/485 mode (JRS485\_2)

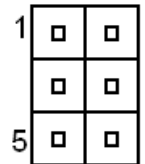
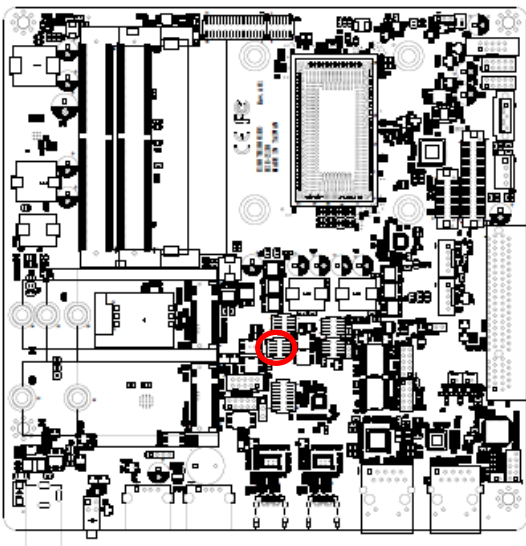

Signal	PIN	PIN	Signal
485_422TX2-	1	2	422RX2-
485_422TX2+	3	4	422RX2+
+5V	5	6	GND

### 5.3.24 Front Audio connector (JFAUD1)

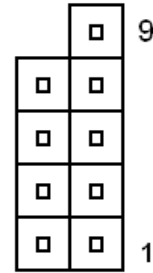
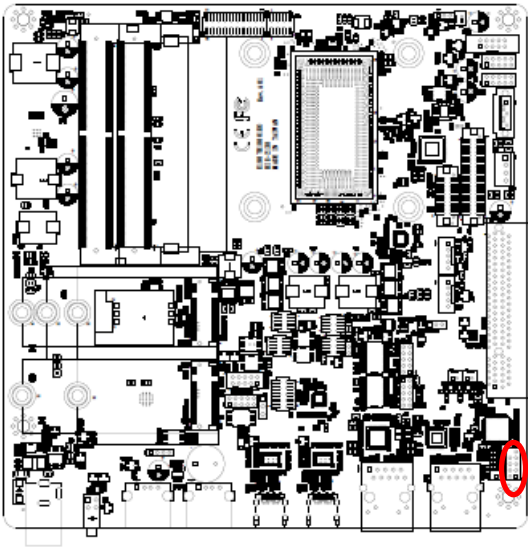

Signal	PIN	PIN	Signal
		9	HP_L
HP1_JD	8	7	GND
MIC1_JD	6	5	HP_R
ACZ_DET#	4	3	MIC1_RIN
GND	2	1	MIC1_LIN

### 5.3.25 Line In, MIC connector (JMIC1)

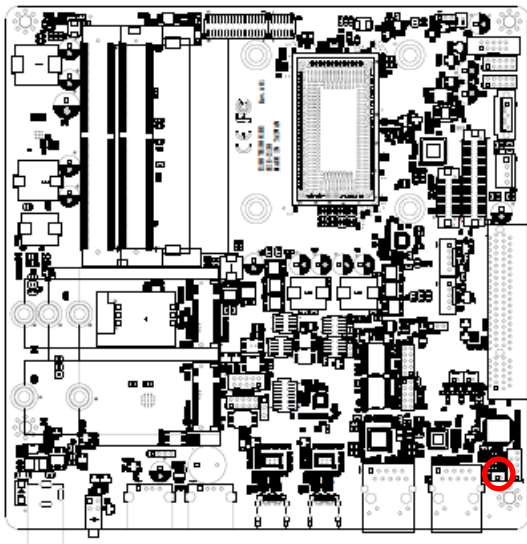

Signal	PIN
MIC2_RIN	1
GND	2



### 5.3.26 LPC connector (JLPC1)

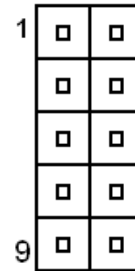
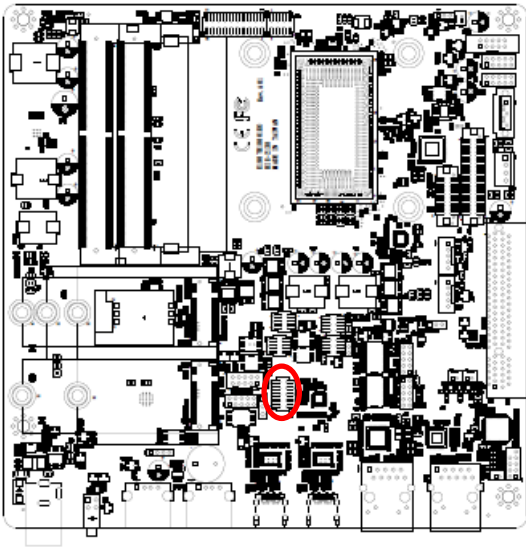

Signal	PIN	PIN	Signal
LPC_AD0	1	2	+3.3V
LPC_AD1	3	4	PLT_BUF_RST#
LPC_AD2	5	6	LPC_LFRAME#
LPC_AD3	7	8	CLK_24M_80
LPC_SERIRQ	9	10	GND

### 5.3.27 I2C EEPROM connector (JPD1)

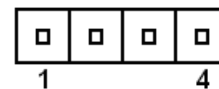
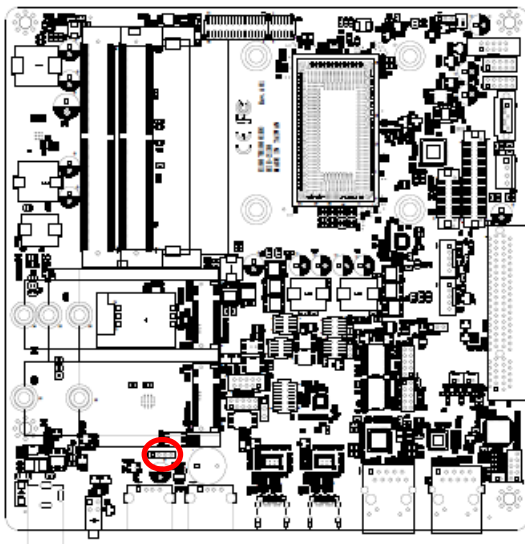

Signal	PIN
LDO_3V3	1
EEPROM_I2C_SCL	2
EEPROM_I2C_SDA	3
GND	4

### 5.3.28 EDP connector (EDP1)

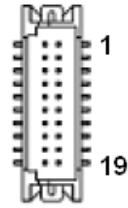
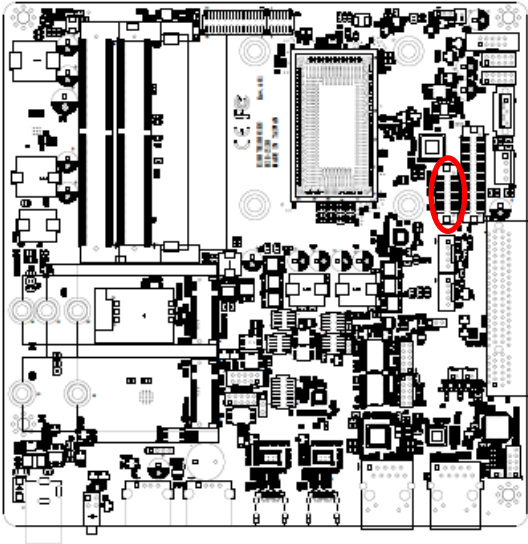

Signal	PIN	PIN	Signal
GND	2	1	GND
EDP_PANEL_TXN3	4	3	EDP_PANEL_TXN0
EDP_PANEL_TXP3	6	5	EDP_PANEL_TXP0
NC	8	7	GND
GND	10	9	EDP_PANEL_TXN1
EDP_PANEL_AUXN	12	11	EDP_PANEL_TXP1
EDP_PANEL_AUXP	14	13	GND
GND	16	15	EDP_PANEL_TXN2
DDIB_HPD	18	17	EDP_PANEL_TXP2
+V3.3S_EDP	20	19	+V3.3S_EDP

## 6. General Safety Guide

For your own safety and that of your equipment, always take the following precautions.

Disconnect the power plug (by pulling the plug, not the cord), from your computer if any of the following conditions exists:

The power cord or plug becomes frayed or otherwise damaged

You spill something into the case

Your computer has been dropped or the case has been otherwise damaged

You suspect that your computer needs service or repair

You want to clean the computer or screen

You want to remove/install any parts

### Thermal

The HID-2138 is a fanless design system, heat is dispatch through rear metal heatsink which is located at VESA mount area.. When using your HID-2138 systems, it is normal for the metal heatsink to get warm. The rear metal heatsink of the HID-2138 functions as a cooling surface that transfers heat from inside the computer to the cooler air outside. Do not block this heatsink by any soft material.

### Disconnect the power

The only way to disconnect power completely is to unplug the adapter power cord. Make sure at least one end of the power cord is within easy reach so that you can unplug the computer when you need to.

**Warning!** *Your AC cord came equipped with a three-wire grounding plug (a plug that has a third grounding pin). This plug will fit only a grounded AC outlet. If you are unable to insert the plug into an outlet because the outlet is not grounded, contact a licensed electrician to replace the outlet with a properly grounded outlet. Do not defeat the purpose of the grounding plug.*



**Warning!** *Never push objects of any kind into this product through the openings in the case. Doing so may be dangerous and result in fire or a dangerous*



*electric shock.*

*Never place anything on system case before turn off computer.*

*Never turn on your computer unless all of its internal and external parts are in place.*

*Operating the computer when it is open or missing parts can be dangerous and can damage your computer.*

## Proper Handling

Handle your HID-2138 with care. It is made of metal, glass, and plastic and has sensitive electronic components inside.

Don't use a damaged HID-2138, such as one with a cracked screen, as it may cause injury.

Setup HID-2138 on a stable work surface.

Do not push objects into the ventilation openings.

To lift or move your system, hold its sides.

When you move your system, do not hit the surface of the glass.

## 7. Guidance and Manufacturer's Declaration

The system complies with the EMC standard IEC60601-1-2: 2007+AC:2010.

 **WARNING** The use of unapproved accessories may diminish system performance.

- NOTE:
- 1 Use of accessories, probes, and cables other than those specified may result in increased emission or decreased immunity of system.
  - 2 The system should not be used adjacent to or stacked with other equipment. If adjacent or stacked use is necessary, system should be observed to verify normal operation in the configuration in which it will be used.
  - 3 The system needs special precautions regarding EMC and needs to be installed and put into service according to the EMC information provided below.
  - 4 Preventing conducted RF immunity. Due to technological limitations, the conducted RF immunity level are limited to 1Vrms level, conducted RF interference above 1Vrms may cause wrong diagnosis and measurements. We suggest that you position system further from sources of conducted RF noise.
  - 5 Operation of system, in the case that the patient physiological signal is lower than the minimum amplitude or value specified in the product specifications, may cause inaccurate results.
  - 6 Portable and mobile RF communications equipment can affects system. See tables 1, 2, 3, and 4 below.

**TABLE1**

<b>GUIDANCE AND THE COMPANY DECLARATION—ELECTROMAGNETIC EMISSIONS</b>		
The system is intended for use in the electromagnetic environment specified below. The customer or the user of system should assure that it is used in such an environment.		
<b>EMISSIONS TEST</b>	<b>COMPLIANCE</b>	<b>ELECTROMAGNETIC ENVIROMENT – GUIDANCE</b>
RF emissions CISPR 11	Group 1	The system uses RF energy only for its internal function. Therefore, its RF emissions are very low and are not likely to cause any interference in nearby electronic equipment.
RF emissions CISPR 11	Class A	The system is suitable for use in all establishments including domestic establishments and those directly connected to the public low-voltage power supply network that supplies buildings used for domestic purposes
Harmonic Emissions IEC 61000-3-2	Class A	
Voltage Fluctuations/ Flicker Emissions IEC 61000-3-3	Compliance	

**TABLE2**

<b>GUIDANCE AND THE COMPANY DECLARATION—ELECTROMAGNETIC IMMUNITY</b>			
The system is intended for use in the electromagnetic environment specified below. The customer or the user of system should assure that it is used in such an environment.			
<b>IMMUNITY TEST</b>	<b>IEC 60601 TEST LEVEL</b>	<b>COMPLIANCE LEVEL</b>	<b>ELECTROMAGNETIC ENVIRONMENT-GUIDANCE</b>
Electrostatic Discharge(ESD) IEC 61000-4-2	±6 kV contact; ±8 kV air	±6 kV contact; ±8 kV air	Floors should be wood, concrete or ceramic tile. If floors are covered with synthetic material, the relative humidity should be at least 30%.
Electrical fast Transient / burst IEC 61000-4-4	±2 kV for power supply voltage; ±1 kV for input/output voltage	±2 kV for power supply voltage; ±1 kV for input/output voltage	Mains power quality should be that of a typical commercial or hospital environment.
Surge IEC 61000-4-5	±1 kV voltage(s) to voltage(s); ±2 kV voltage(s) to earth	±1 kV voltage(s) to voltage(s); ±2 kV voltage(s) to earth	Mains power quality should be that of a typical commercial or hospital environment.
Voltage dips, Short interruptions and voltage variation on power supply input voltage IEC 61000-4-11	<5% $U_T$ (>95% dip in $U_T$ ) for 0.5 cycle  40% $U_T$ (60% dip in $U_T$ ) for 5 cycle  70% $U_T$ (30% dip in $U_T$ ) for 25 cycle  <5% $U_T$ (>95% dip in $U_T$ ) for 5 sec	<5% $U_T$ (>95% dip in $U_T$ ) for 0.5 cycle  40% $U_T$ (60% dip in $U_T$ ) for 5 cycle  70% $U_T$ (30% dip in $U_T$ ) for 25 cycle  <5% $U_T$ (>95% dip in $U_T$ ) for 5 sec	Mains power quality should be that of a typical commercial or hospital environment. If you require continued operation during power mains interruptions, it is recommended that our product be powered from an uninterruptible power supply or a battery.

Power frequency (50/60 HZ) magnetic field IEC 61000-4-8	3 A/m	3 A/m	Power frequency magnetic fields should be at levels characteristic of a typical location in a typical commercial or hospital environment.
NOTE: $U_T$ is the A.C. mains voltage prior to application of the test level.			

**TABLE3**



<b>GUIDANCE AND THE COMPANY DECLARATION—ELECTROMAGNETIC IMMUNITY</b>			
The system is intended for use in the electromagnetic environment specified below. The customer or the user of system should assure that it is used in such an environment.			
<b>IMMUNITY TEST</b>	<b>IEC 60601 TEST LEVEL</b>	<b>COMPLIANCE LEVEL</b>	<b>ELECTROMAGNETIC ENVIRONMENT-GUIDANCE</b>
Conducted RF IEC 61000-4-6	3 Vrms 150 kHz - 80 MHz	1 Vrms	<p>Portable and mobile RF communications equipment should be used no closer to any part of system, including cables, than the recommended separation distance calculated from the equation applicable to the frequency of the transmitter. Recommended separation distance</p> $d = 3.5 \times \sqrt{P}$ $d = 1.2 \times \sqrt{P} \quad 80 \text{ MHz to } 800 \text{ MHz}$ $d = 2.3 \times \sqrt{P} \quad 800 \text{ MHz to } 2.5\text{GHz}$
Radiated RF IEC 61000-4-3	3 V/m 80MHz - 2.5GHz	3 V/m	<p>Where, P is the maximum output power rating of the transmitter in watts (W) according to the transmitter manufacturer and d is the recommended separation distance in meters (m).</p> <p>Field strengths from fixed RF transmitters, as determined by an electromagnetic site survey, should be less than the compliance level in each frequency range.</p> <p>Interference may occur in the vicinity of equipment marked with the following symbol:</p> <div style="text-align: center;">  </div>

**Note 1** At 80 MHz and 800 MHz, the higher frequency range applies.

**Note 2** These guidelines may not apply in all situations. Electromagnetic propagation is affected by absorption and reflection from structures, objects and people.

- Field strengths from fixed transmitters, such as base stations for radio (cellular /cordless) telephones and land mobile radios, amateur radio, AM and FM radio broadcast and TV broadcast cannot be predicted theoretically with accuracy. To assess the electromagnetic environment due to fixed RF transmitters, an electromagnetic site survey should be considered. If the measured field strength in the location in which system is used exceeds the applicable RF compliance level above, system should be observed to verify normal operation. If abnormal performance is observed, additional measures may be necessary, such as reorienting or relocating system.
- Over the frequency ranges 150kHz to 80MHz, field strengths should be less than 1V/m.

**TABLE4**

<b>RECOMMENDED SEPARATION DISTANCES BETWEEN PORTABLE AND MOBILE RF COMMUNICATION DEVICE AND SYSTEM</b>			
<p>The system is intended for use in an electromagnetic environment in which radiated RF disturbance are controlled. The customer or the user of system can help prevent electromagnetic interference by maintaining a minimum distance between portable and mobile RF communication equipment (transmitters) and system as recommended below, according to the maximum output power of the communication equipment.</p>			
<b>Rated Maximum Output power of Transmitter (W)</b>	<b>Separation Distance According to Frequency of Transmitter (m)</b>		
	150kHz -80MHz $d = \left[ \frac{3.5}{1} \right] \sqrt{P}$	80MHz-800MHz $d = \left[ \frac{3.5}{3} \right] \sqrt{P}$	800MHz-2.5GHz $d = \left[ \frac{7}{3} \right] \sqrt{P}$
0.01	0.35	0.12	0.23
0.1	1.11	0.37	0.74
1	3.50	1.17	2.34
10	11.07	3.69	7.38
100	35.00	11.67	23.34
<p>For transmitters at a maximum output power not listed above, the recommended separation distanced in meters (m) can be determined using the equation applicable to the frequency of the transmitter, where P is the maximum output power rating of the transmitter in watts (W) according to the transmitter manufacturer.</p> <p>If system image distortion occurs, it may be necessary to position system further from sources of conducted RF noise or to install external power source filter to minimize RF noise to an acceptable level.</p> <p>Note 1 At 80 MHz and 800 MHz, the separation distance for the higher frequency range applies.</p> <p>Note 2 These guidelines may not apply in all situations. Electromagnetic propagation is affected by absorption and reflection from structures, objects and people.</p>			